



**Extended Keyboard IT-E254 for IT8500+
Series Electronic Loads**

User's Manual

Content

Instrument Introduction	2
IT-E254 Dimension Figure	3
IT-E254 Appearance Introduction	5
1. Keyboard Introduction	5
2. Interface Introduction	6
3. Indicator Introduction	7
IT-E254 Placing Manner	8
IT-E254 Function Introduction	9
1. Automatic Testing	9
2. Relay Function	10
3. Pedal switch Function	12

Instrument Introduction

IT-E254 is applicable to auto-test of ITECH IT8500+ series electronic loads and will greatly save your test time due to its powerful functions and easy operations. Main functions:

- Control the Start/Stop/Pause of auto-test
- Go to the next step at any time during test
- Display testing results with Pass/Fault indicator
- Input ON/OFF control
- Recall auto-test documents
- Esc key
- Enter key
- Relay control of DUT power
- Pedal switch function realization

IT-E254 Dimension Figure

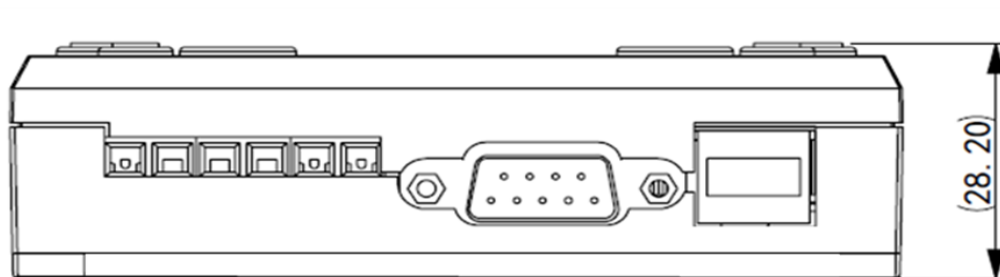
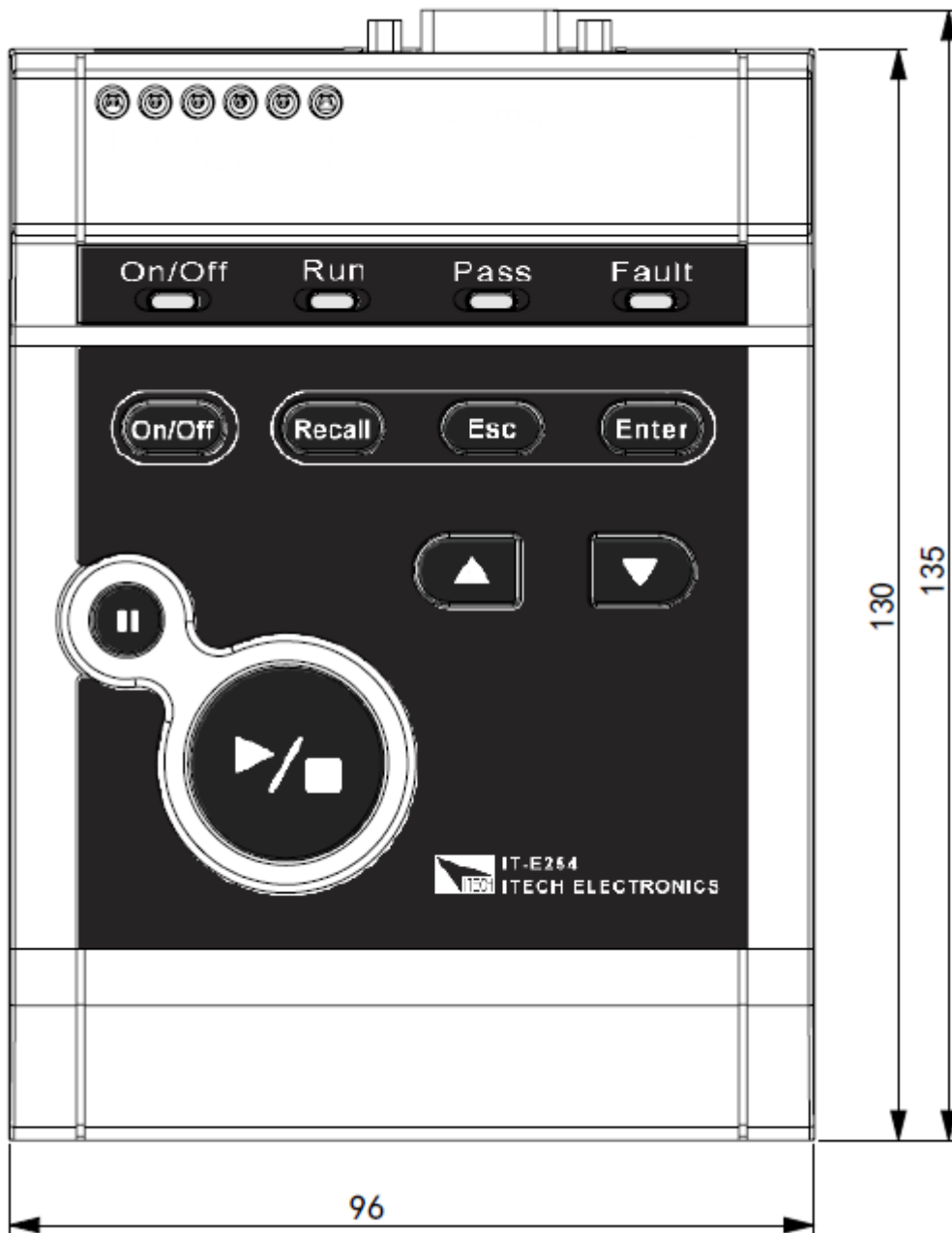

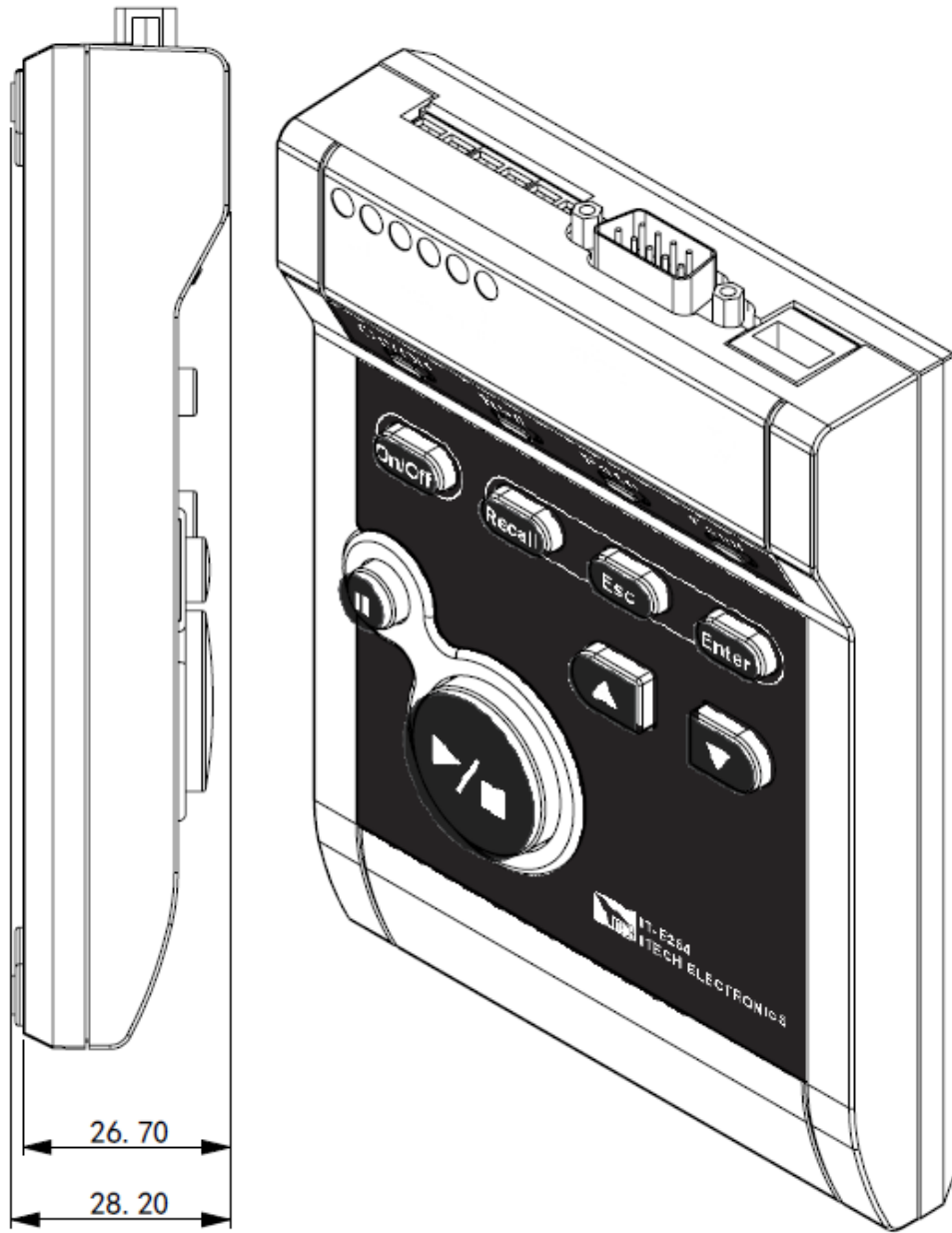







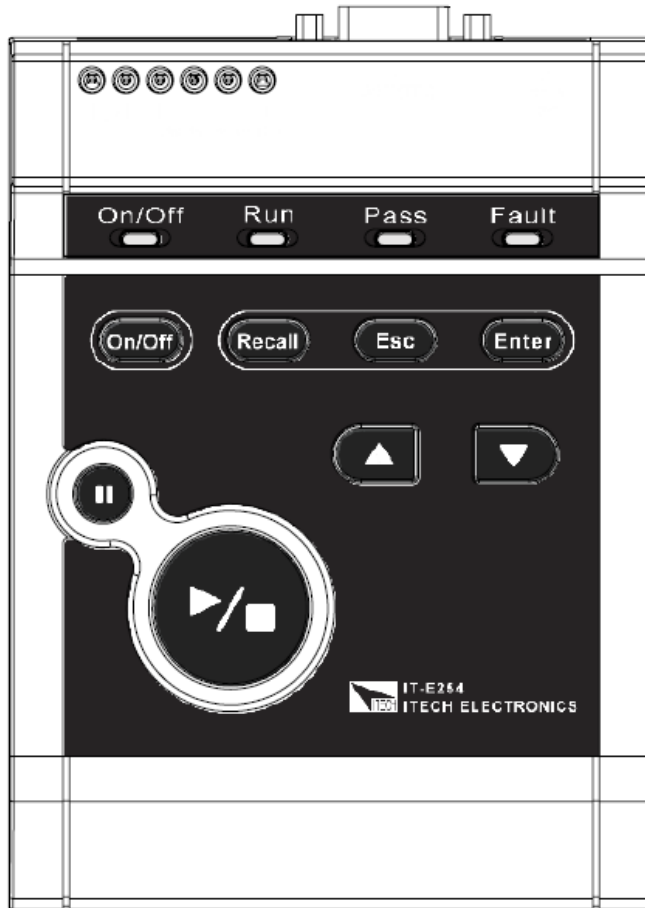



Unit: mm

IT-E254 Appearance Introduction

1. Keyboard Introduction



-  **On/Off** When the auto-test is paused, press the key to enable the IT8500+ in a loaded or unloaded status;
-  **Recall** Press the key and hold it for 2 seconds to recall the auto-test documents;
-  **Esc** Esc key. Used for exiting the current status.
-  **Enter** Enter key. Press the key after the auto-test completed to view the test data.
-  **▲** Up key. Used for selecting the auto-test documents, or for viewing the test data together with  **Enter** ;
-  **▼** Down key. Used for selecting the auto-test documents, or for viewing the test data together with  **Enter** ;
-  **▶/■** Press the key to run auto-test. Or, when the auto-test is ongoing, press the key again to complete the test.
-  **||** When the auto-test is ongoing, press the key to pause the test; or, when the test is paused, press the key again to continue the test.

2. Interface Introduction

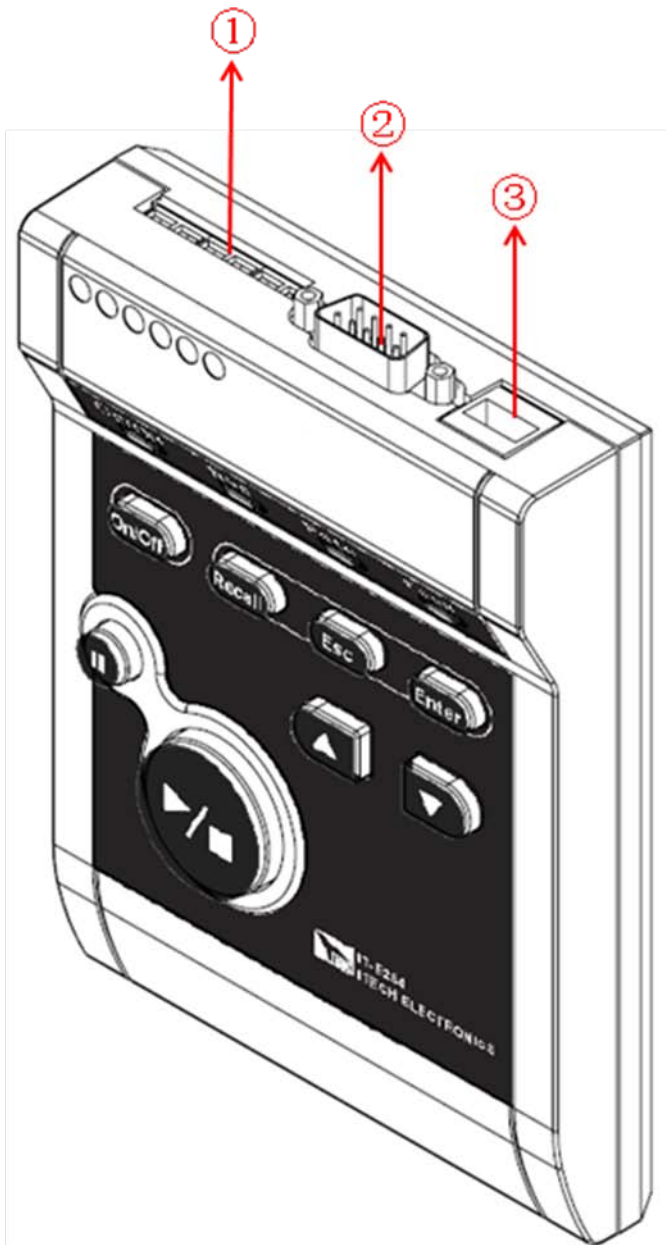

- ① For function pins of the relay and of the pedal switch, refer to the Function Introduction.
- ② COM port
- ③ DC IN 5V port, used for receiving power from computers or other USB available for providing DC 5V power (Current < 1 A). This auxiliary power, under normal conditions, can be unconnected.

3. Indicator Introduction



On/Off: When it is lighted on, it indicates that the IT8500+ is under loaded status (the indicator turns yellow-green); when it is lighted off, it indicates that the IT8500+ is under unloaded status;

Run: When it flickers, it indicates that the auto-test is ongoing (the indicator turns yellow-green); when it is lighted off, it indicates that the auto-test is completed;

Pass: When it is lighted on, it indicates that the auto-test is successful (the indicator turns yellow-green);

Fault: When it is lighted on, it indicates that the auto-test is failed (the indicator turns red).

IT-E254 Placing Manner

IT-E254 can be held by hands or be placed on a plane for operation.

IT-E254 can be absorbed to iron surfaces due to its magnetic bottom. During test, adjust the way you place IT-E254 based on actual requirements.

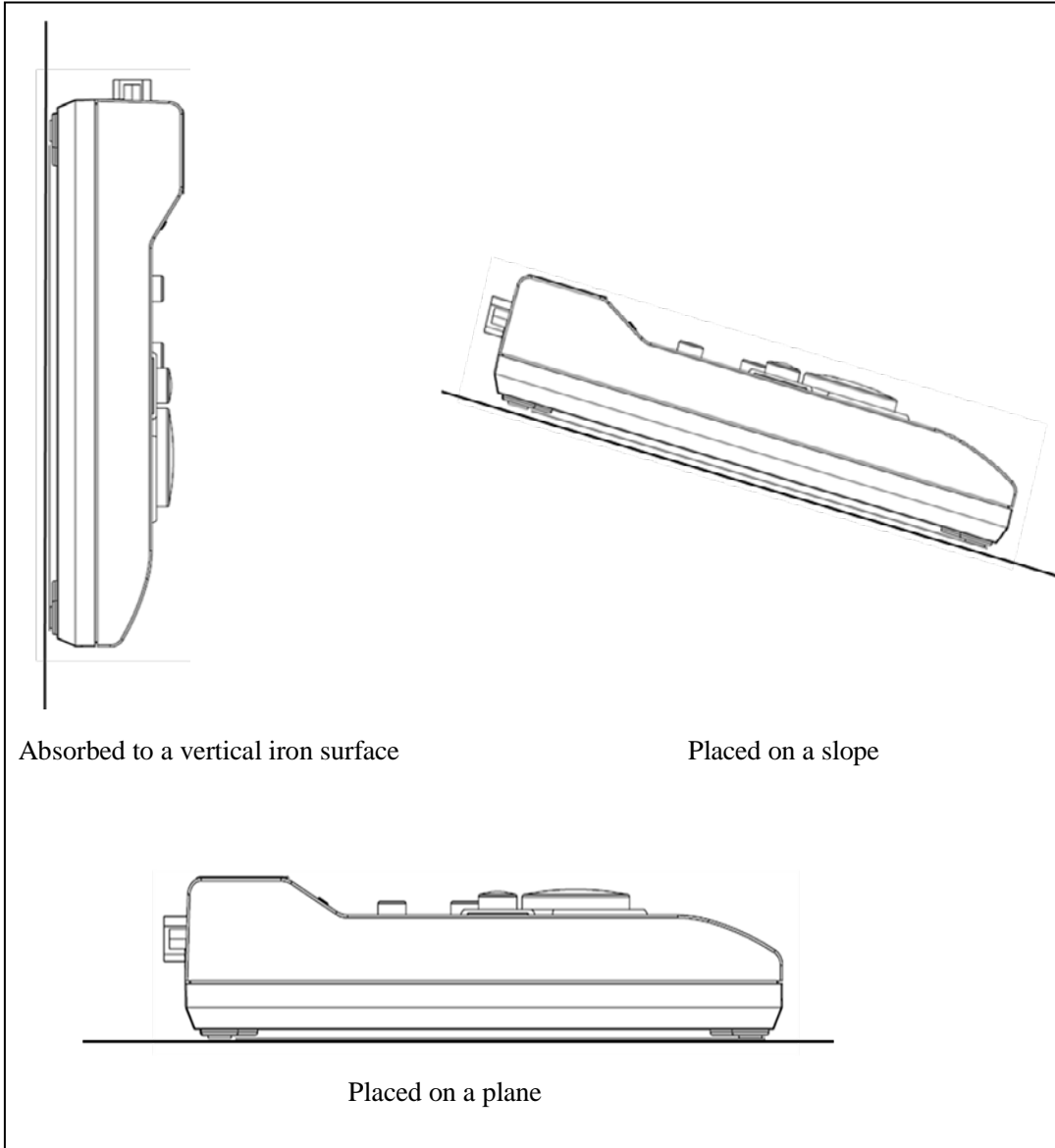

IT-E254 Function Introduction

1. Automatic Testing



Connecting to Keyboard

When IT8500+ is powered off, connect the DB9 port on the IT8500+ rear board to the IT-E254 COM port with the IT-E254 built-in RS232. Connect the IT-E254 “DC IN 5V” port to the computer USB port with the USB transmission line (Or you may choose not to connect).

Press the Power Key on the IT8500+ front board. Under normal conditions, the 4 indicators on the IT-E254 extended keyboard will be lighted on from left to right one by one (refer to the Indicator Introduction of Appearance Introduction). Light them on again and the 4 indicators will flicker by twice simultaneously.

Editing the Automatic Testing

IT-E254 only supports IT8500+ auto-test modes. Therefore, in the first place, select the auto-test mode on the system menu as “New”. Specific operation is as follows:

Press the  (Shift)+  (System) keys to enter the system menu. And select the TESTMOD menu as NEW.



TESTMOD	TESTMODE	
	NEW	Auto-test editing mode specific to IT8500+
	IT8500	Auto-test editing mode compatible to IT8500

For details, refer to the Menu Description in the IT8500+ User's Manual.

Edit and save the auto-test documents. For auto-test editing and saving operations, refer to the IT8500+ User's Manual.

Setting the Run Mode

Before auto-test, the Run Mode of IT8500+ electronic load should be set in the first place.

Press the  (Shift)+  (System) keys to enter the system menu and select the RUNMODE Menu as PROG_TEST.

RUNMODE	RUN	
	NORMAL	Normal mode
	BATTERY	Battery test mode
	PROG_TEST	automatic test mode

	OCP_TEST	Over current protection test
	OPP_TEST	Over power protection test



For details, refer to the IT8500+ User's Manual.



Running the Automatic Testing

Press  and hold it for 2 seconds. The VFD will display RECALL PROGRAM= N

Press  /  to adjust figures. Press  to recall the edited auto-test documents.

Press  to run test. During test, the Run indicator flickers.

Press  again to stop test. Press  to pause test. When the test is paused, press  to switch on/off the load input.

During test, press  /  to go to the previous/next test. Final testing results should exclude the switched steps with no testing results.

Viewing the Testing Results

During auto-test, the testing results can be displayed by the indicators. When the Pass indicator is lighted on, it indicates that the auto-test at current step succeeds (the indicator turns yellow-green); when the Fault indicator is lighted on, it indicates that the auto-test at current step fails (the indicator turns red). The Fault indicator will always be red once any test step is failed.

When the auto-test is completed, the testing results will also be displayed by the indicators. The Pass indicator will be lighted on if every step of test is passed; otherwise, the Fault indicator will be lighted on.

When the auto-test is completed, press  and  /  to view the test value and result of every step.

2. Relay Function

As an auxiliary function supporting the auto-test, the relay function controls the disconnection/connection of the DUT input power. Press  to run test. Wait for connection of the DUT input power; after the test is completed, the DUT input power will be disconnected.

Note: If the DUT is energized, there will be no outputs till initialization. Please appropriately extend the test time of the first step of auto-test (plus the time for DUT initialization) so as not to influence the testing results.

Warning: To avoid high-voltage electrical shock, it is prohibited to connect the DC/AC input terminals before connecting the Pins 1 and 2 (The exposed wires should be adhered with insulated rubber tapes). It is prohibited to touch the exposed wires of Pins 1 and 2 during test.

Wiring Method

Connect the Pins 1 and 2 (as shown below) to the DUT input power line. In this case, the DUT is the UUT.

Note: if the DUT adopts AC input, the maximum input voltage is 265 V and maximum capacity 1,250 VA; and if the DUT adopts DC input, the maximum input voltage is 30 V and maximum capacity 150 W. If the DUT input parameters go beyond the above scope, to avoid damage to the product, do not use relay function.

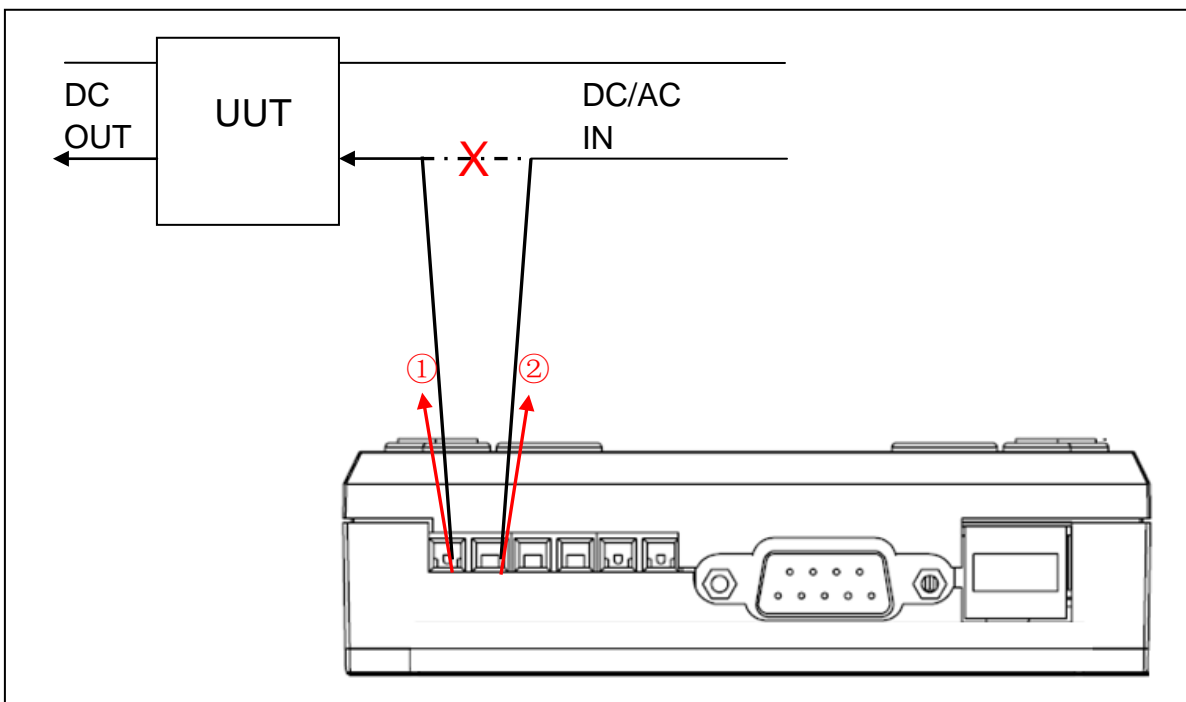



3. Pedal switch Function

This function is to realize pedal switch test, which controls Start/Stop and Pause of the auto-test and switch-on/switch-off of the load input.

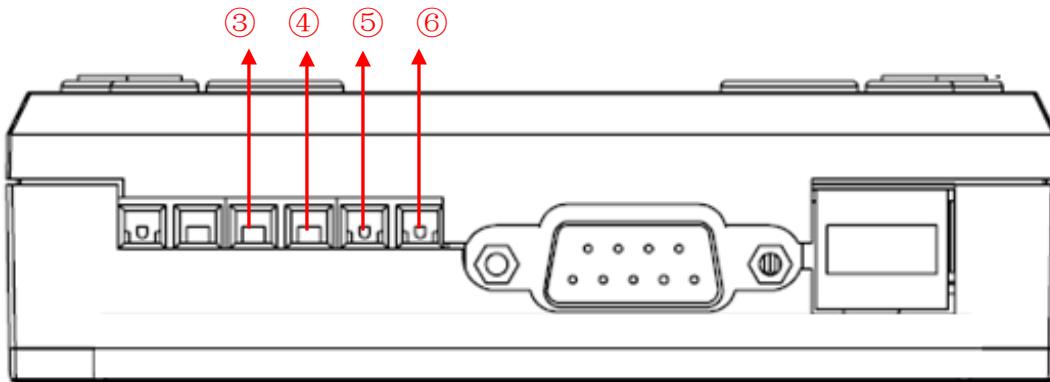
Pins: Pins 3, 4, 5 and 6 (as shown below, from left to right).



Pin 3 is a common GND;

Functions controlled by Pins 4, 5 and 6 are corresponding to the keys ,  and  respectively.

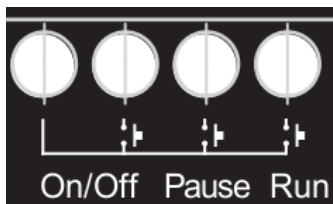



Contact US

Thank you for purchasing ITECH products. If you have any doubt about this product, please contact us as follow.

1. Please refer to the CD-ROM of related user's manual in package.
2. Click www.itechate.com or scan the right two-dimension code to visit the ITECH website
3. Send E-mail to fae@itech.sh or dial the service hot-line in China: 4006025000.
4. Select the most convenient contact method for further consultancy.

