

# Programmable DC Electronic Load

## IT8900A/E Series User Manual

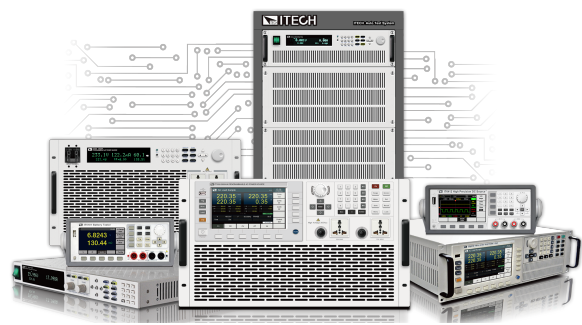

Model: IT8900A/E Series  
Version: V2.1/8,2019

# Notices

© Itech Electronic, Co., Ltd. 2019

No part of this manual may be reproduced in any form or by any means (including electronic storage and retrieval or translation into a foreign language) without prior permission and written consent from Itech Electronic, Co., Ltd. as governed by international copyright laws.

## Manual Part Number



402225

## Trademarks

Pentium is U.S. registered trademarks of Intel Corporation.

Microsoft, Visual Studio, Windows and MS Windows are registered trademarks of Microsoft Corporation in the United States and/or other countries and regions.

## Warranty

The materials contained in this document are provided “as is”, and is subject to change, without prior notice, in future editions. Further, to the maximum extent permitted by applicable laws, ITECH disclaims all warranties, either express or implied, with regard to this manual and any information contained herein, including but not limited to the implied warranties of merchantability and fitness for a particular purpose. ITECH shall not be held liable for errors or for incidental or indirect damages in connection with the furnishing, use or application of this document or of any information contained herein. Should ITECH and the user enter into a separate written agreement with warranty terms covering the materials in this document that conflict with these terms, the warranty terms in the separate agreement shall prevail.

## Technology Licenses

The hardware and/or software described herein are furnished under a license and may be used or copied only in accordance with the terms of such license.

## Restricted Rights Legend

Restricted permissions of the U.S. government. Permissions for software and technical data which are authorized to the U.S. Government only include those for custom provision to end users. ITECH follows FAR 12.211 (technical data), 12.212 (computer software). DFARS 252.227-7015 (technical data—commercial products) for national defense and DFARS 227.7202-3 (permissions for commercial computer software or computer software documents) while providing the customized business licenses of software and technical data.

## Safety Notices

### CAUTION

A CAUTION sign denotes a hazard. It calls attention to an operating procedure or practice that, if not correctly performed or adhered to, could result in damage to the product or loss of important data. Do not proceed beyond a CAUTION sign until the indicated conditions are fully understood and met.

### WARNING

A WARNING sign denotes a hazard. It calls attention to an operating procedure or practice that, if not correctly performed or adhered to, could result in personal injury or death. Do not proceed beyond a WARNING sign until the indicated conditions are fully understood and met.



### Note

A NOTE sign denotes important hint. It calls attention to tips or supplementary information that is essential for users to refer to.

## Quality Certification and Assurance

We certify that series instrument meets all the published specifications at time of shipment from the factory.

## Warranty

ITECH warrants that the product will be free from defects in material and workmanship under normal use for a period of one (1) year from the date of delivery (except those described in the Limitation of Warranty below).

For warranty service or repair, the product must be returned to a service center designated by ITECH.















- The product returned to ITECH for warranty service must be shipped PRE-PAID. And ITECH will pay for return of the product to customer.
- If the product is returned to ITECH for warranty service from overseas, all the freights, duties and other taxes shall be on the account of customer.

## Limitation of Warranty

This Warranty will be rendered invalid in case of the following:

- Damage caused by circuit installed by customer or using customer own products or accessories;
- Modified or repaired by customer without authorization;
- Damage caused by circuit installed by customer or not operating our products under designated environment;
- The product model or serial number is altered, deleted, removed or made illegible by customer;
- Damaged as a result of accidents, including but not limited to lightning, moisture, fire, improper use or negligence.

## Safety Symbols

	Direct current		ON ( power)
	Alternating current		OFF ( power)
	Both direct and alternating current		Power-on state
	Chassis (earth ground) symbol.		Power-off state
	Earth ( ground) terminal		Reference terminal
	Caution		Positive terminal
	Warning ( refer to this manual for specific Warning or Caution information)		Negative terminal
	A chassis terminal	-	-

## Safety Precautions

The following safety precautions must be observed during all phases of operation of this instrument. Failure to comply with these precautions or specific warnings elsewhere in this manual will constitute a default under safety standards of design, manufacture and intended use of the instrument. ITECH assumes no liability for the customer's failure to comply with these precautions.



**WARNING**

- **Do not use the instrument if it is damaged. Before operation, check the casing to see whether it cracks. Do not operate the instrument in the presence of inflammable gasses, vapors or dusts.**
  - **The instrument is provided with a power cord during delivery and should be connected to a socket with a protective earth terminal, a junction box or a three-phase distribution box. Before operation, be sure that the instrument is well grounded.**
  - **Please always use the provided cable to connect the instrument.**
  - **Check all marks on the instrument before connecting the instrument to power supply.**
  - **Ensure the voltage fluctuation of mains supply is less than 10% of the working voltage range in order to reduce risks of fire and electric shock.**
  - **Do not install alternative parts on the instrument or perform any unauthorized modification.**
  - **Do not use the instrument if the detachable cover is removed or loosen.**
  - **To prevent the possibility of accidental injuries, be sure to use the power adapter supplied by the manufacturer only.**
  - **We do not accept responsibility for any direct or indirect financial damage or loss of profit that might occur when using the instrument.**
  - **This instrument is used for industrial purposes, do not apply this product to IT power supply system.**
  - **Never use the instrument with a life-support system or any other equipment subject to safety requirements.**
-

**WARNING**

- **SHOCK HAZARD Ground the Instrument.** This product is provided with a protective earth terminal. To minimize shock hazard, the instrument must be connected to the AC mains through a grounded power cable, with the ground wire firmly connected to an electrical ground (safety ground) at the power outlet or distribution box. Any interruption of the protective (grounding) conductor or disconnection of the protective earth terminal will cause a potential shock hazard that could result in injury or death.
- **Before applying power, verify that all safety precautions are taken.** All connections must be made with the instrument turned off, and must be performed by qualified personnel who are aware of the hazards involved. Improper actions can cause fatal injury as well as equipment damage.
- **SHOCK HAZARD, LETHAL VOLTAGES** This product can input the dangerous voltage that can cause personal injury, and the operator must always be protected from electric shock. Ensure that the input electrodes are either insulated or covered using the safety covers provided, so that no accidental contact with lethal voltages can occur.
- **Never touch cables or connections immediately after turning off the instrument.** Verify that there is no dangerous voltage on the electrodes or sense terminals before touching them.

**CAUTION**

- **Failure to use the instrument as directed by the manufacturer may render its protective features void.**
- **Always clean the casing with a dry cloth. Do not clean the internals.**
- **Make sure the vent hole is always unblocked.**

## Environmental Conditions

The instrument is designed for indoor use and an area with low condensation. The table below shows the general environmental requirements for the instrument.

Environmental Conditions	Requirements
Operating temperature	0°C ~ 40°C
Operating humidity	20% ~ 80%( non-condensation)

Environmental Conditions	Requirements
Storage temperature	-10°C ~ 70 °C
Altitude	Operating up to 2,000 meters
Installation category	II
Pollution degree	Pollution degree 2



**Note**

In order to ensure the accuracy of measurement, it is recommended to operate the instrument half an hour after start-up.

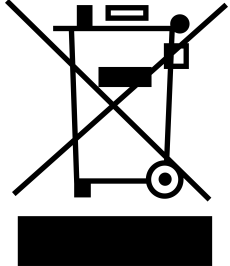
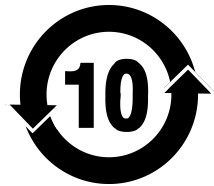
## Regulation Tag

	<p>The CE tag shows that the product complies with the provisions of all relevant European laws (if the year is shown, it indicates that the year when the design is approved).</p>
	<p>This instrument complies with the WEEE directive (2002/96/EC) tag requirements. This attached product tag shows that the electrical/electronic product cannot be discarded in household waste.</p>
	<p>This symbol indicates that no danger will happen or toxic substances will not leak or cause damage in normal use within the specified period. The service life of the product is 10 years. The product can be used safely within the environmental protection period; otherwise, the product should be put into the recycling system.</p>

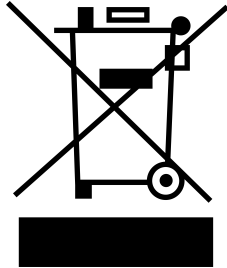
## Waste Electrical and Electronic Equipment (WEEE) Directive



Waste electrical and electronic equipment (WEEE) directive, 2002/96/EC

The product complies with tag requirements of the WEEE directive (2002/96/EC). This tag indicates that the electronic equipment cannot be disposed of as ordinary household waste. Product Category

According to the equipment classification in Annex I of the WEEE directive, this instrument belongs to the "Monitoring" product.

If you want to return the unnecessary instrument, please contact the nearest sales office of ITECH.

## Compliance Information

Complies with the essential requirements of the following applicable European Directives, and carries the CE marking accordingly:

- Electromagnetic Compatibility (EMC) Directive 2014/30/EU
- Low-Voltage Directive (Safety) 2014/35/EU

Conforms with the following product standards:

### EMC Standard

IEC 61326-1:2012/ EN 61326-1:2013 <sup>123</sup>

#### Reference Standards

CISPR 11:2009+A1:2010/ EN 55011:2009+A1:2010 (Group 1, Class A)

IEC 61000-4-2:2008/ EN 61000-4-2:2009

IEC 61000-4-3:2006+A1:2007+A2:2010/ EN 61000-4-3:2006+A1:2008+A2:2010

IEC 61000-4-4:2004+A1:2010/ EN 61000-4-4:2004+A1:2010

IEC 61000-4-5:2005/ EN 61000-4-5:2006

IEC 61000-4-6:2008/ EN 61000-4-6:2009

IEC 61000-4-11:2004/ EN 61000-4-11:2004

1. The product is intended for use in non-residential/non-domestic environments. Use of the product in residential/domestic environments may cause electromagnetic interference.
2. Connection of the instrument to a test object may produce radiations beyond the specified limit.
3. Use high-performance shielded interface cable to ensure conformity with the EMC standards listed above.

### Safety Standard

IEC 61010-1:2010/ EN 61010-1:2010

## Content

Quality Certification and Assurance .....	I
Warranty .....	I
Limitation of Warranty .....	I
Safety Symbols .....	II
Safety Precautions .....	II
Environmental Conditions .....	IV
Regulation Tag .....	V
Waste Electrical and Electronic Equipment (WEEE) Directive .....	VI
Compliance Information .....	VII
1 Inspection and Installation .....	1
1.1 Verifying the Shipment .....	1
1.2 Instrument Size Introduction .....	2
1.3 Connecting the cabinet .....	6
1.4 Connecting the Power Cord .....	8
1.5 Connecting the DUT .....	10
2 Quick Reference .....	14
2.1 Brief Introduction .....	14
2.2 Front Panel Introduction .....	16
2.3 Keyboard Introduction .....	17
2.4 Fast Function Key .....	18
2.5 Function Description of VFD Status Indicators .....	19
2.6 Rear Panel Introduction .....	19
2.7 Power-on Selftest .....	25
3 Function and Features .....	28
3.1 Switching of Local/Remote Operation Modes .....	28
3.2 Constant-status Operation Mode .....	29
3.2.1 Constant Current Operation Mode ( CC ) .....	29
3.2.2 Constant Voltage Operation Mode ( CV ) .....	30
3.2.3 Constant Resistance Operation Mode ( CR ) .....	31
3.2.4 Constant Power Operation Mode ( CW ) .....	32
3.2.5 Compound Operation Mode .....	33
3.3 Input Control Function .....	34
3.4 Keyboard Locking Function .....	35
3.5 Short-circuit Analog Function .....	35
3.6 System Menu Function(System) .....	35
3.6.1 Restored to Factory Setting(Initialize) .....	37
3.6.2 Power On Parameter(Power-On) .....	37
3.6.3 Key Sound Set(Buzzer) .....	37
3.6.4 Rotary Knob Set(Knob) .....	37
3.6.5 Trigge Mode(Trigger) .....	38
3.6.6 Set Memory Group(Memory>Group) .....	38
3.6.7 Loading Time Display Set(Displ) .....	38
3.6.8 Communication Set .....	39
3.7 Configuration menu function (Config) .....	39
3.7.1 On-Timer Set(Protect>Time) .....	41
3.7.2 Auto-Switching Voltage Range Set(Measure>V-Range) .....	42
3.7.3 Setting Filter(Measure>Filter) .....	42
3.7.4 Set transient over power loading capability(Enhance Power) .....	42
3.8 Triggering Function .....	43
3.9 Dynamic Test Function .....	44
3.9.1 Continuous Mode .....	44
3.9.2 Pulse Mode .....	46
3.9.3 Toggle Mode .....	48
3.10 OCP Test Function .....	49
3.11 OPP Test Function .....	50

3.12	Battery discharge test function .....	51
3.13	CR-LED test function .....	52
3.14	Measure Function .....	55
3.15	Configuration Save Function .....	56
3.16	VON Function .....	57
3.17	Protective Function .....	59
3.17.1	Overvoltage Protection (OVP).....	59
3.17.2	Overcurrent Protection (OCP).....	60
3.17.3	Overpower Protection (OPP).....	60
3.17.4	Overtemperature Protection (OTP).....	61
3.17.5	Current Oscillation Protection(OSC).....	61
3.18	List Operation.....	62
3.19	Terminal Function of Rear Panel .....	64
3.19.1	External Trigger Function .....	65
3.19.2	External On/Off Control .....	65
3.19.3	Voltage Fault Indication .....	66
3.19.4	External Analog Function .....	66
3.19.5	Current Monitoring (I Monitor) .....	66
3.20	Auto Test Function .....	67
3.21	Parallel Function .....	72
4	Technical Specification.....	74
4.1	Main specifications.....	74
4.1.1	IT8902A-150-200.....	74
4.1.2	IT8902A-600-140.....	76
4.1.3	IT8902A-1200-80.....	78
4.1.4	IT8902E-150-200.....	79
4.1.5	IT8902E-600-140.....	81
4.1.6	IT8902E-1200-80.....	83
4.1.7	IT8904A-150-400.....	85
4.1.8	IT8904A-600-280.....	87
4.1.9	IT8904A-1200-160 .....	89
4.1.10	IT8904E-150-400 .....	91
4.1.11	IT8904E-600-280.....	92
4.1.12	IT8904E-1200-160 .....	94
4.1.13	IT8906A-150-600 .....	96
4.1.14	IT8906A-600-420 .....	98
4.1.15	IT8906A-1200-240 .....	100
4.1.16	IT8906E-150-600 .....	102
4.1.17	IT8906E-600-420 .....	104
4.1.18	IT8906E-1200-240 .....	105
4.1.19	IT8912A-150-1200 .....	107
4.1.20	IT8912A-600-840 .....	109
4.1.21	IT8912A-1200-480 .....	111
4.1.22	IT8912E-150-1200 .....	112
4.1.23	IT8912E-600-840 .....	114
4.1.24	IT8912E-1200-480 .....	116
4.1.25	IT8918A-150-1800 .....	117
4.1.26	IT8918A-600-1260 .....	119
4.1.27	IT8918A-1200-720 .....	121
4.1.28	IT8918E-150-1800 .....	122
4.1.29	IT8918E-600-1260 .....	124
4.1.30	IT8918E-1200-720 .....	126
4.1.31	IT8924A-150-2400 .....	127
4.1.32	IT8924A-600-1680 .....	129
4.1.33	IT8924A-1200-960 .....	131
4.1.34	IT8924E-150-2400 .....	132
4.1.35	IT8924E-600-1680 .....	134
4.1.36	IT8924E-1200-960 .....	136

4.1.37	IT8930A-150-2400 .....	137
4.1.38	IT8930A-600-2100 .....	139
4.1.39	IT8930A-1200-1200 .....	141
4.1.40	IT8930E-150-2400 .....	142
4.1.41	IT8930E-600-2100 .....	144
4.1.42	IT8930E-1200-1200 .....	146
4.1.43	IT8936A-150-2400 .....	147
4.1.44	IT8936A-600-2400 .....	149
4.1.45	IT8936A-1200-1440 .....	151
4.1.46	IT8936E-150-2400 .....	152
4.1.47	IT8936E-600-2400 .....	154
4.1.48	IT8936E-1200-1440 .....	156
4.1.49	IT8942A-150-2400 .....	157
4.1.50	IT8942A-600-2400 .....	159
4.1.51	IT8942A-1200-1680 .....	161
4.1.52	IT8942E-150-2400 .....	162
4.1.53	IT8942E-600-2400 .....	164
4.1.54	IT8942E-1200-1680 .....	166
4.1.55	IT8948A-150-2400 .....	167
4.1.56	IT8948A-600-2400 .....	169
4.1.57	IT8948A-1200-1920 .....	171
4.1.58	IT8948E-150-2400 .....	172
4.1.59	IT8948E-600-2400 .....	174
4.1.60	IT8948E-1200-1920 .....	176
4.1.61	IT8954A-150-2400 .....	177
4.1.62	IT8954A-600-2400 .....	179
4.1.63	IT8954A-1200-2160 .....	181
4.1.64	IT8954E-150-2400 .....	182
4.1.65	IT8954E-600-2400 .....	184
4.1.66	IT8954E-1200-2160 .....	186
4.1.67	IT8960E-600-2400 .....	187
4.2	Additional features .....	189
5	References of Load Communication Interfaces.....	190
5.1	RS-232 interface .....	190
5.2	USB interface .....	192
5.3	GPIB interface.....	192
5.4	LAN interface .....	193
A	Appendix .....	194
A.1	Specifications of Red and Black Test Lines.....	194
A.2	Fuse Replacement .....	195



# 1 Inspection and Installation

- ◆ Verifying the Shipment
- ◆ Instrument Size Introduction
- ◆ Connecting the cabinet
- ◆ Connecting the Power Cord
- ◆ Connecting the DUT

## 1.1 Verifying the Shipment

Open the package and check the articles within package box before operation. In case of any non-conformity, missing or appearance wearing, please contact ITECH immediately.

**Table 1–1 Package box contents (to a machine as a reference standard)**

Device name	Quantity	Model	Remarks
Electronic load	1	IT8900A/E series	Please refer to <a href="#">2.1 Brief Introduction</a> for complete models of IT8900A/E series electronic loads.
Power cord	1	IT-E171/IT-E172/ IT-E173/ IT-E174	User may select an appropriate power cord that matches the specifications of power socket used in the area. See the section <a href="#">Categories of power cords</a> for details.
Red and black test lines	a set	-	The load whose power is greater than or equal to 10KW in this series are standard equipped with a set of red and black test line, the test line specification is 95mm <sup>2</sup> / 2m.
CD	1	-	Comprising user manual and documents related to programming and grammatical guidelines.

Device name	Quantity	Model	Remarks
Factory alignment report	1	-	Test report before delivery.
USB communication cable	1	-	This accessory is selected when the USB interface is used for starting up remote operation.



**Note**

After confirming that package contents are consistent and correct, please appropriately keep package box and related contents. The package requirements should be met when the instrument is returned to factory for repair.

## 1.2 Instrument Size Introduction

The instrument should be installed at well-ventilated and rational-sized space. Please select appropriate space for installation based on the electronic load size.

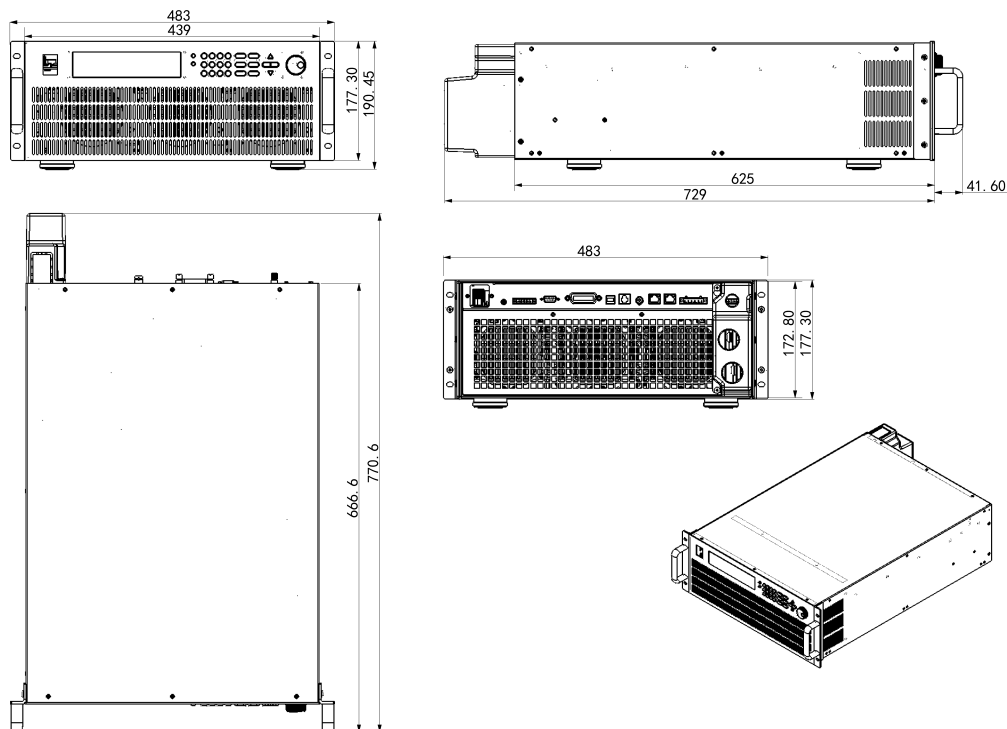
### 4U Model



**8U Model**

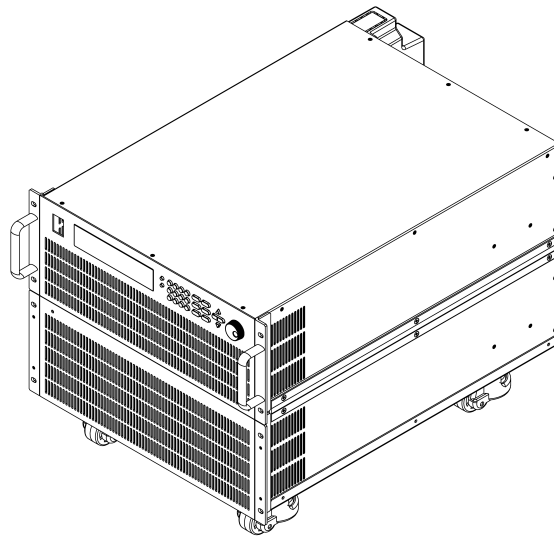
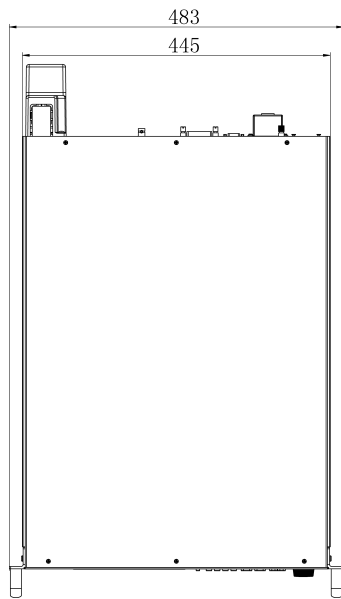
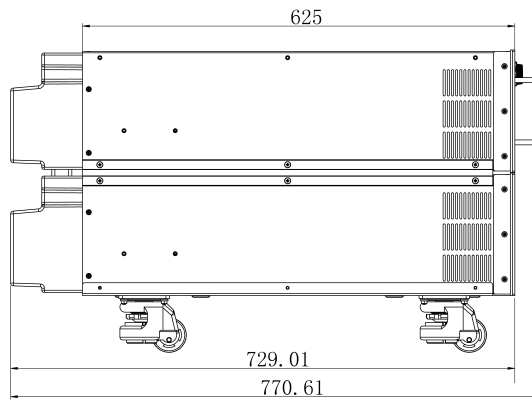
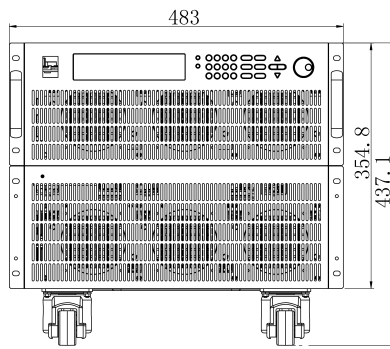

15U Model

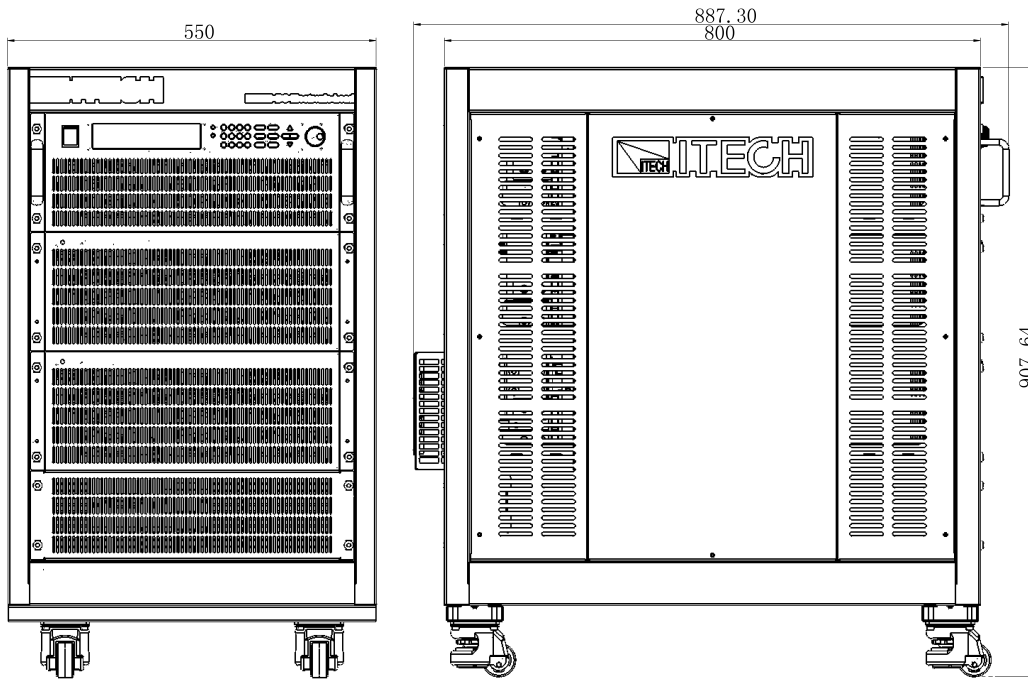

27U Model

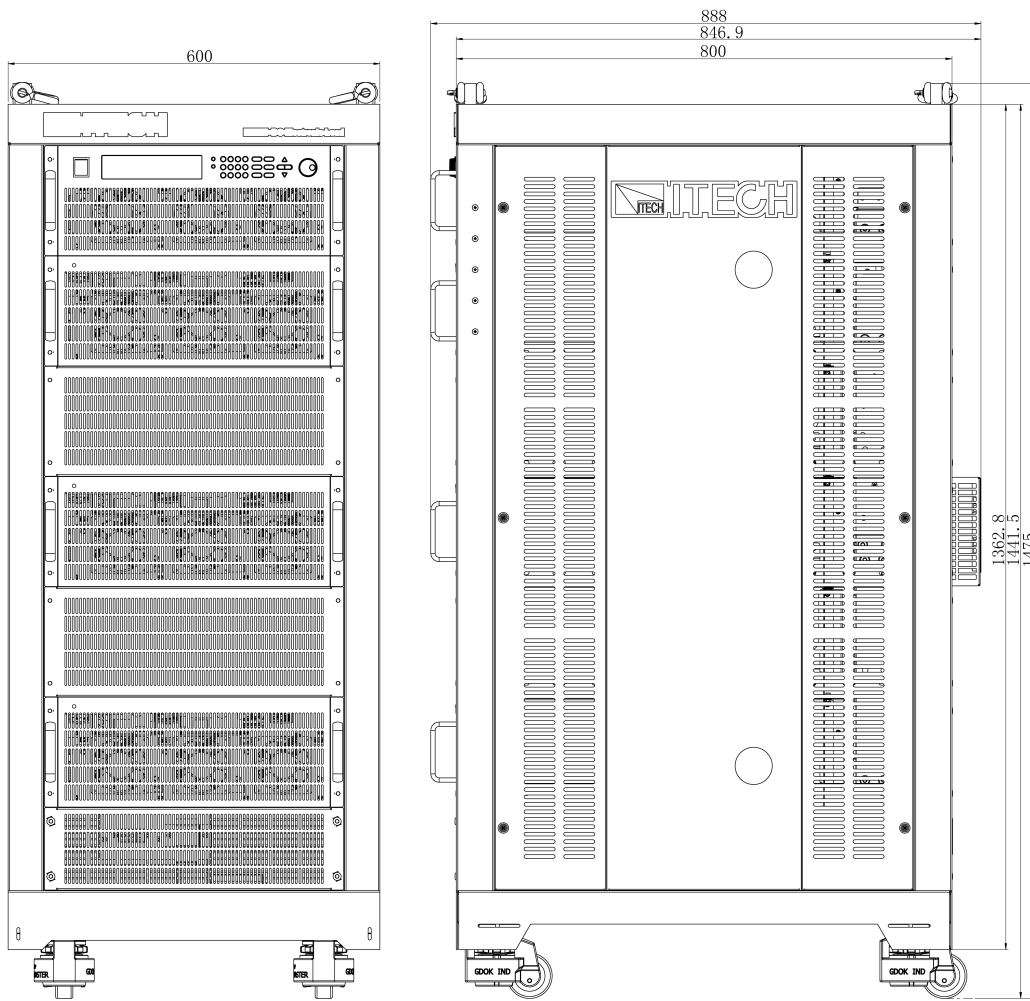

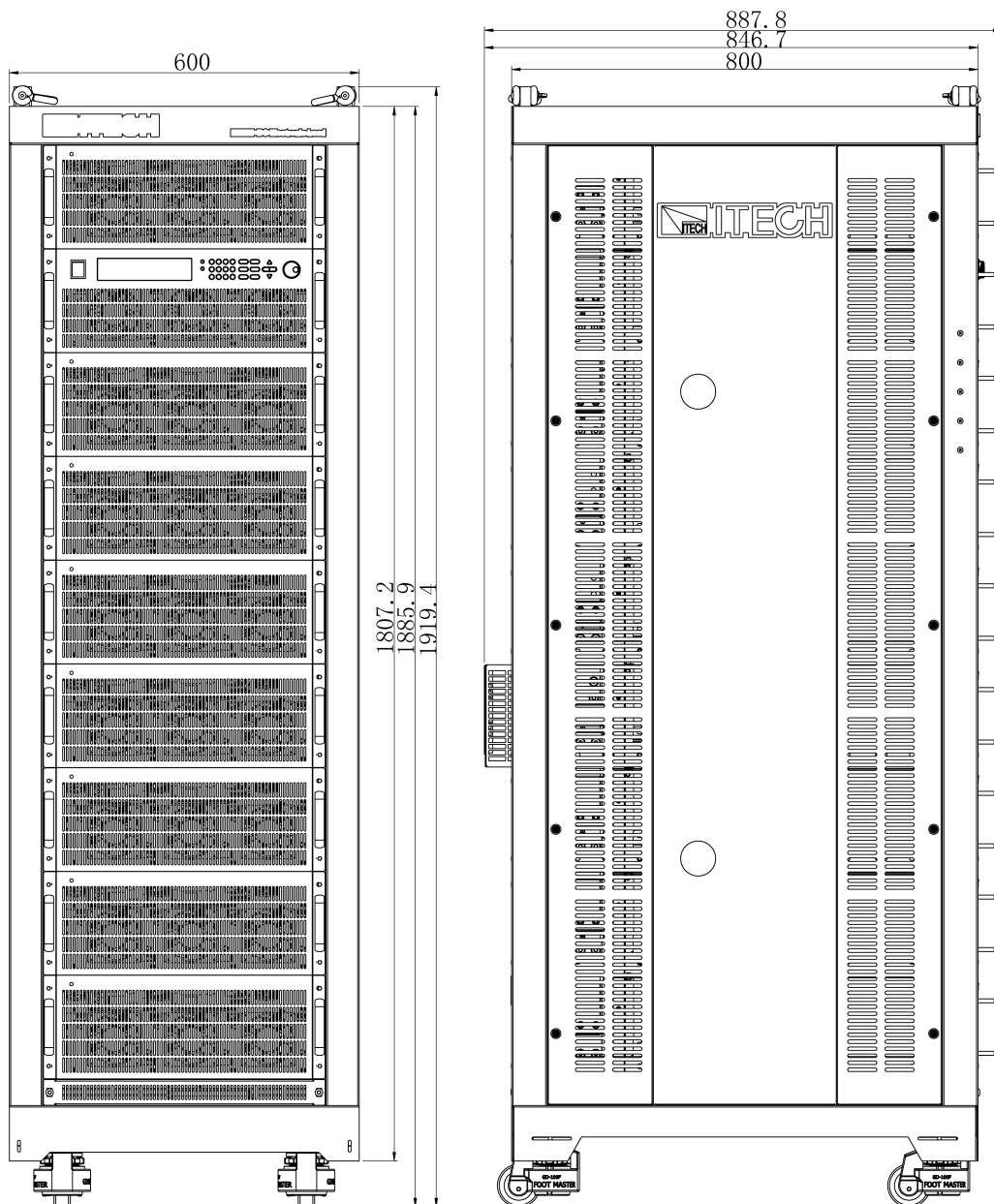
**37U Model**

## 1.3 Connecting the cabinet

Over 60KW models of IT8900A/E series consist of two cabinets. The user needs to connect parallel cable and analog signal terminals between the two cabinets. Before connecting, the user needs to loosen the screws and take apart the rear panel which covers the terminals by using a screwdriver. Take example of IT8960E-600-2400, the wiring diagram is shown as follows. Please refer to [2.6 Rear Panel Introduction](#) for the detailed rear panel introduction.

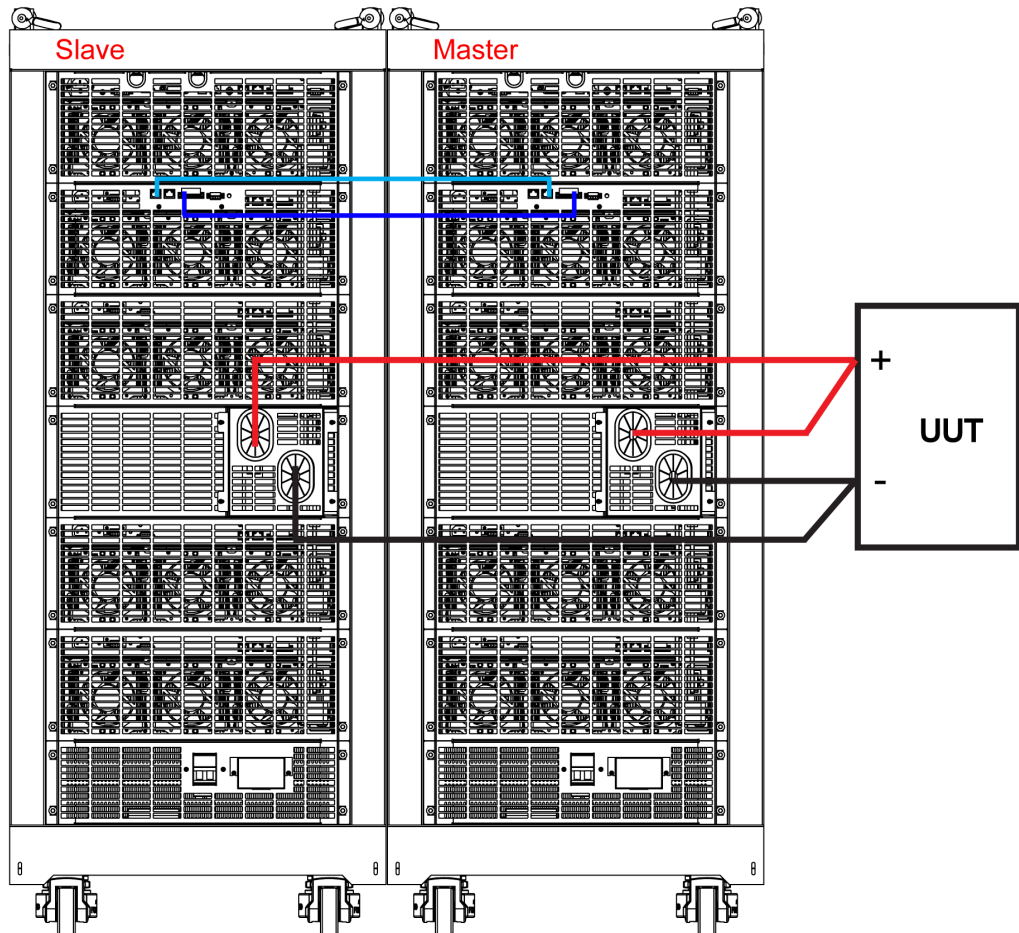

### Operation Steps:

1. Connect the instruments according to the above diagram.
  - a. Connect the parallel cable. Connect Out terminal of the master to the In terminal of the slave.
  - b. Connect the analog signal terminals. Connect the Pin 4, 5 and 6 of the master to the Pin 1, 2 and 3 of the slave respectively.
  - c. Connect UUT. Refer to [1.5 Connecting the DUT](#) for detailed wiring method.
2. After connection, configure one electric load as a master unit and the other electronic loads as slave units.
  - a. Press the composite key **[Shift]+[8]**(System) to enter the System Menu.
  - b. Press the Right key to select "Parallel" and press **[Enter]** for parallel setting.
    - Single: Single mode.
    - Slave: Slave mode.
    - Master: Master mode. If Master mode is selected, you need to set the number of Slaves for the Master.
    - Total: total number of instruments in parallel. For example, Total = 2.
3. After making the master-slave setting, to ensure normal operation, you need to restart the electronic loads.

## 1.4 Connecting the Power Cord

### Before connect

To avoid burning out and electric shock, The safety precautions must be observed.

#### **WARNING**

- To avoid burning out, be sure to confirm that the power voltage matches with the supply voltage.
- If the working voltage of the instrument supports 110V or 220V, before connecting the power cord, please confirm the 110V / 220V transfer switch to ensure that the switch of the load matches the supply voltage. Otherwise, the instrument may be damaged.
- Please ensure the power switch of the instrument is turned Off.
- To avoid burning out and electric shock, please only use the power cord supplied as a standard accessory.
- Be sure to connect the main power socket to the power outlet with protective grounding. Do not use terminal board without protective grounding.
- To prevent electric shock, be sure to take protective earthing. Please connect the power cable to the socket with the protective earth terminal.
- Do not use an extended power cord without protective grounding, otherwise the protection function will fail.
- Please use the AC power socket matching the power cord shipped with the box and take the protective earthing measures. If you can not use a suitable AC power cord, do not use the instrument.

### AC power input level

Working voltage for IT8900A/E series electronic load is 100V~240V, AC power input level: 100V~240V 50Hz/60Hz

### Power Cord Type and Connecting Method

- 4U and 8U models provides the standard power cords as below. Please select appropriate power cords appropriate to local voltage based on the specifications of power cords below. If purchased model fails to meet local voltage requirements, please contact distributor or factory for change.



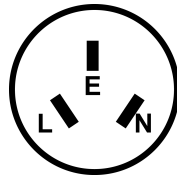

China  
IT-E171

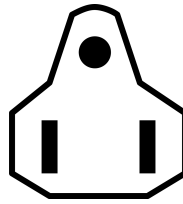

United States &  
Canada & Japan  
IT-E172

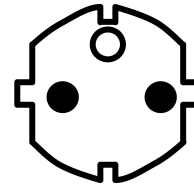

Europe  
IT-E173

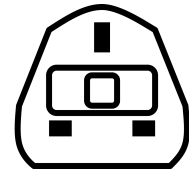

England  
IT-E174

### Connecting Method:

1. Please ensure the power switch of the instrument is turned Off.
2. Connect one end of the power cord to the AC input connector on the rear panel of the instrument.
3. Connect the other end of the power cord to the socket configured with protective earth.

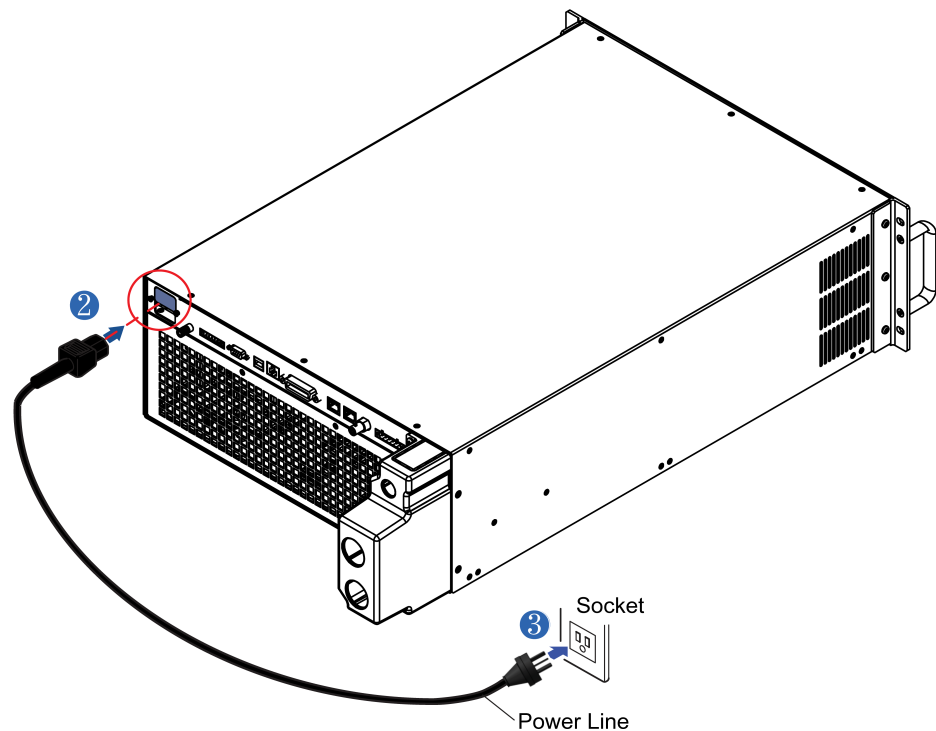

- Other models (15U, 27U and 37U instruments) provides the standard power cords as below.



### Connecting Method:

1. Please ensure the power switch of the instrument is turned Off.
2. Remove the protective cover outside the AC input terminal on the rear panel.

3. See the below illustration, connect one end of the AC power cord to the AC input terminal in the rear board of the instrument. Connect the fire wire, zero line and ground to the corresponding terminal of the device. Connect the brown terminal to line (L), blue to neutral (N), and yellow-green to ground.
4. Mount the protective cover back to its original position.
5. Connect the plug on the other end of the power cord to a grounded AC outlet.

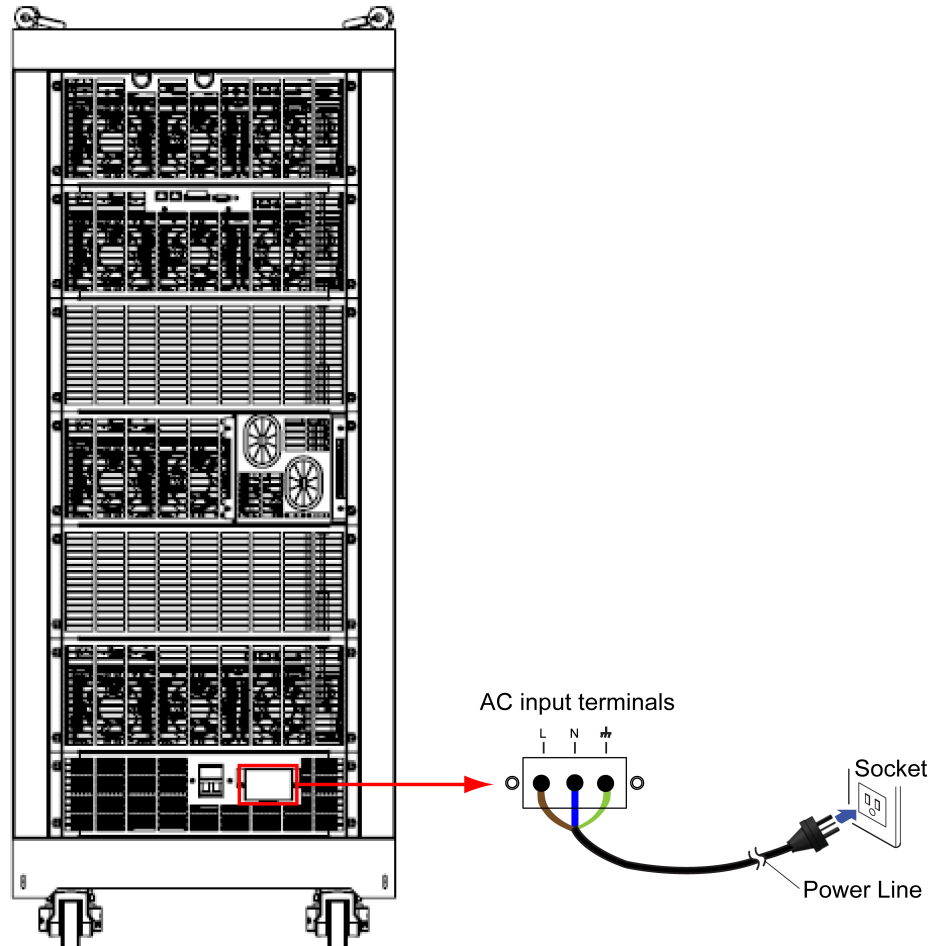

## 1.5 Connecting the DUT

### Before connecting the DUT

To avoid burning out and electric shock, The safety precautions must be observed.

**WARNING**

- Before connecting the DUT, be sure to switch off the power supply of the test loop in order to avoid electric shock.
- To avoid electric shock, before testing, please make sure the rating values of the testing lines, and do not measure the current that is higher than the rating value.
- Always use test lines provided by ITECH to connect the equipment. If test lines from other factories are used, please check that the test line can withstand maximum current.

**Specification**

- Test lines are not standard accessories of the 4U instruments. Please select optional red and black test lines for individual sales based on the maximum current value. For specifications of test lines and maximum current values, refer to [A.1 Specifications of Red and Black Test Lines](#).

If you want to make test lines by yourself, please refer to the maximum current value and the poles' size, as shown in the following figure.

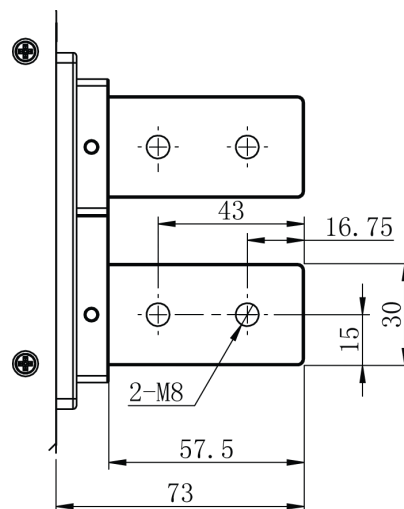

- Other models (8U, 15U, 27U and 37U instruments) are standard equipped with a set of red and black test lines, the test lines specification are 95mm<sup>2</sup> / 3m. However, for instruments with a rated current greater than 500A, the user need to purchase additional 1 to 5 test lines. Please select optional red and black test lines for individual sales based on the maximum current value. For specifications of test lines and maximum current values, refer to [A.1 Specifications of Red and Black Test Lines](#).

If you want to make test lines by yourself, please refer to the maximum current value and specifications of standard test lines.

**Connecting the DUT ( local measurement )**

The steps of local measurement are as follows:

1. Before connecting the test lines, be sure that the instrument Power is in Off position.
2. Remove the load input terminal cover.
3. Loosen the screws of the input terminals and connect the red and black test lines to the input terminals. Re-tighten the screws.

When maximum current that one test line can withstand fails to meet the current rated current, use several pieces of red and black test lines. For example, the maximum current is 1,200A, then 4 pieces of 360A red and black lines are required.

4. Install the load input terminal cover.
5. Directly connect the other end of the red and black lines to the DUT terminals.

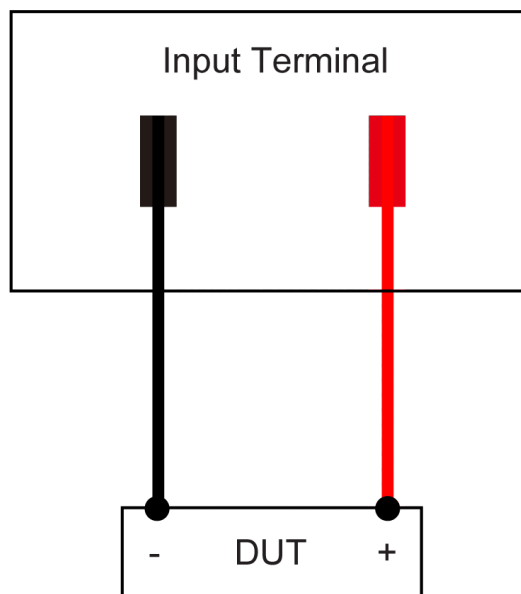

### Connecting the DUT ( remote measurement )

Under CC, CV, CR or CW mode, if the load consumes large current, a large voltage drop will be detected in connection line between tested instrument and load terminal. To ensure measurement accuracy, a remote sense measurement terminal is provided at load rear board to compensate voltage drop lost in wire.

Remote sense operation: VS+ and VS- are remote input terminals. To avoid voltage drop caused by long input wire of load, the remote sense test allows direct measurement at input terminal source so as to improve measurement accuracy.

The steps of remote measurement are as follows:

1. Press **[Shift]+[9]**(Config) keys to enter the interface of configuration menu.
2. Operate Left/Right key and select Remote-Sense. Press **[Enter]** key.
3. Select ON to start Sense function; the instrument is set to remote sense measurement mode.
4. Connect the instrument and DUT as shown in the following figure.

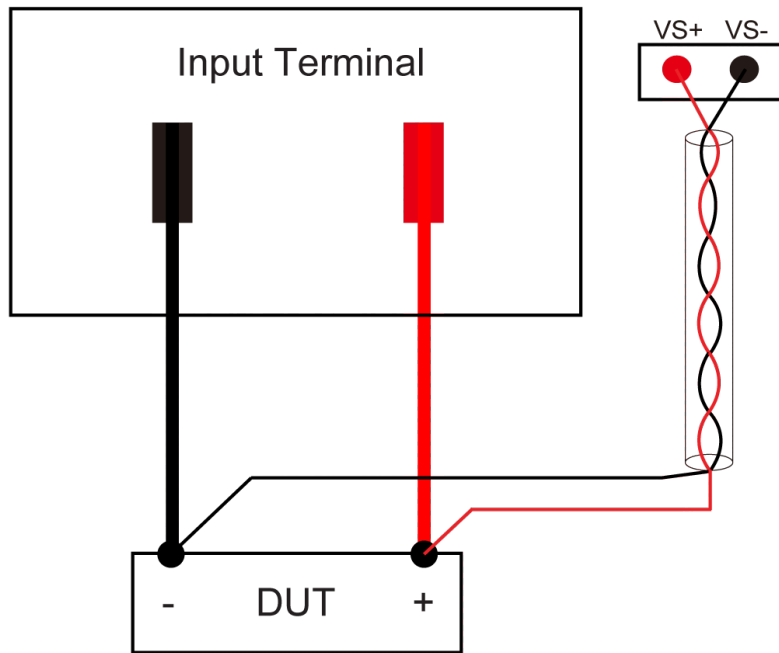

**Note**

Test lines and sense lines should be as short as possible, and sense lines should be twisted together.

# 2 Quick Reference

This Chapter will introduce power-on check steps of this series to ensure normal start-up and usage under initialization status of the load. Besides, to facilitate usage, this part also displays the functions of front board, rear board and keyboard keys as well as display functions to a quick view of load appearance, structure and key usage functions before operation.

- ◆ [Brief Introduction](#)
- ◆ [Front Panel Introduction](#)
- ◆ [Keyboard Introduction](#)
- ◆ [Fast Function Key](#)
- ◆ [Function Description of VFD Status Indicators](#)
- ◆ [Rear Panel Introduction](#)
- ◆ [Power-on Selftest](#)

## 2.1 Brief Introduction

IT8900A/E series high performance high power DC electronic load provides three voltage ranges 150V/600V/1200V, power from 2kW to 60kW. IT8900A/E series, with ultra-wide voltage and current range, is controlled by an independent master unit. The power expands to 384kW by master-slave paralleling. Ultra-high power density, 6kW is with only 4U height .

IT8900A/E series has eight (A series) /four (E series) working modes, faster loop response and current rising and falling speed, as well as dynamic mode, OCP test, OPP test, automatic test and battery test functions. Built-in LAN, GPIB, USB, RS232 and analog interfaces, etc., IT8900A/E series has comprehensive protection function, which can be applied to power battery discharge, DC charging station, on-board charger (OBC), power electronics and other power electronics products.

This series delivers special functions and advantages at international level, including:

- Input power: 2 kW, 4 kW, 6 kW, 12 kW, 18 kW, 24 kW, 30 kW, 36 kW, 42 kW, 48 kW, 54 kW, 60 kW
- Voltage range: 150V, 600V, 1200V
- Current range: up to 600A for 4u modules (up to 2400A for 27u racks)
- Master/slave paralleling control, maximum power expands to 384kW
- Multiple operating modes: CC, CV, CR, CP, CC+CV, CV+CR, CR+CC, CW +CC\*1

- Transient over-power loading capability \*2
- Adjustable CV loop speed, match different power supplies
- 30kHz high-speed dynamic mode, adjustable current rising and falling time\*3
- 500kHz high-speed voltage and current sampling rate
- Time measurement, battery discharge test function
- Short circuit simulation, automatic test function
- Timing control list programming
- I-monitor
- Built-in LAN, USB, RS232, GPIB, external analog control interface
- OCP/OPP test function
- High-precision voltage and current measurement
- Protection functions: OVP, OCP, OPP, OTP, current oscillation protection, limited current protection, limited power protection, reverse alarm protection etc.
- Up to 100 groups' memories, with power off memory function
- Independent master unit control for easy maintenance installation

\*1 IT8900E only supports CC, CV, CR, CP operation mode.

\*2 Over-power is only suitable for IT8900A series model, IT8900E dynamic response is 10 kHz.

\*3 30kHz is only suitable for 150V model.

Input parameter	150V	600V	1200V	height
2 kW	IT8902A/E-150-200	IT8902A/ E-600-140	IT8902A/ E-1200-80	4 U
4 kW	IT8904A/ E-150-400	IT8904A/ E-600-280	IT8904A/ E-1200-160	4 U
6 kW	IT8906A/ E-150-600	IT8906A/ E-600-420	IT8906A/ E-1200-240	4 U
12 kW	IT8912A/ E-150-1200	IT8912A/ E-600-840	IT8912A/ E-1200-480	8 U
18 kW	IT8918A/ E-150-1800	IT8918A/ E-600-1260	IT8918A/ E-1200-720	15 U
24 kW	IT8924A/ E-150-2400	IT8924A /E-600-1680	IT8924A/ E-1200-960	27 U
30 kW	IT8930A/E-150-2400	IT8930A/E-600-2100	IT8930A/E-1200-1200	27U
36 kW	IT8936A/E-150-2400	IT8936A/E-600-2400	IT8936A/E-1200-1440	27U
42 kW	IT8942A/E-150-2400	IT8942A/E-600-2400	IT8942A/E-1200-1680	37U
48 kW	IT8948A/E-150-2400	IT8948A/E-600-2400	IT8948A/E-1200-1920	37U
54 kW	IT8954A/E-150-2400	IT8954A/E-600-2400	IT8954A/E-1200-2160	37U
60 kW	-	IT8960E-600-2400	-	27U*2

The curves indicating relationship between the rated input power and input voltage of IT8900A/E series load is shown in the following figure.

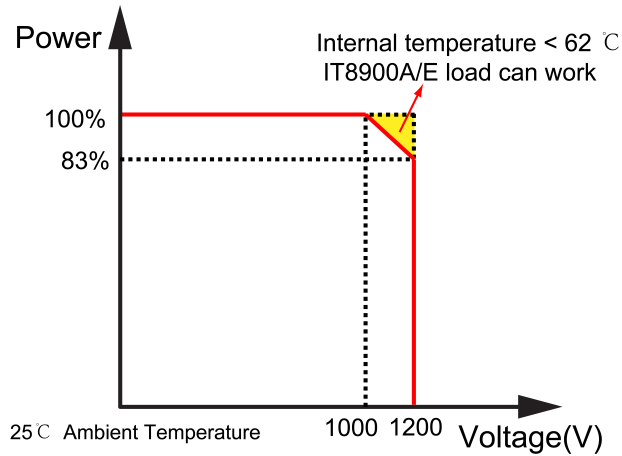

### Note

- The same model in IT8900A series and IT8900E series has identical voltage, current and power ratings, while IT8900A series is high-end electronic load which performs better in speed, dynamic, current accuracy and operation modes, and IT8900E series is economical and more cost efficient.
- The naming rule of the IT8900 series is IT89XX-YY-ZZ, where XX represents the rated power of the model, YY represents the rated voltage and ZZ represents the rated current.

## 2.2 Front Panel Introduction

All of the series IT8900A/E electronic loads have the same front panel. The front panel diagram and key diagram of 4U model is shown in the figure below; descriptions of the numbered items follow the figure.

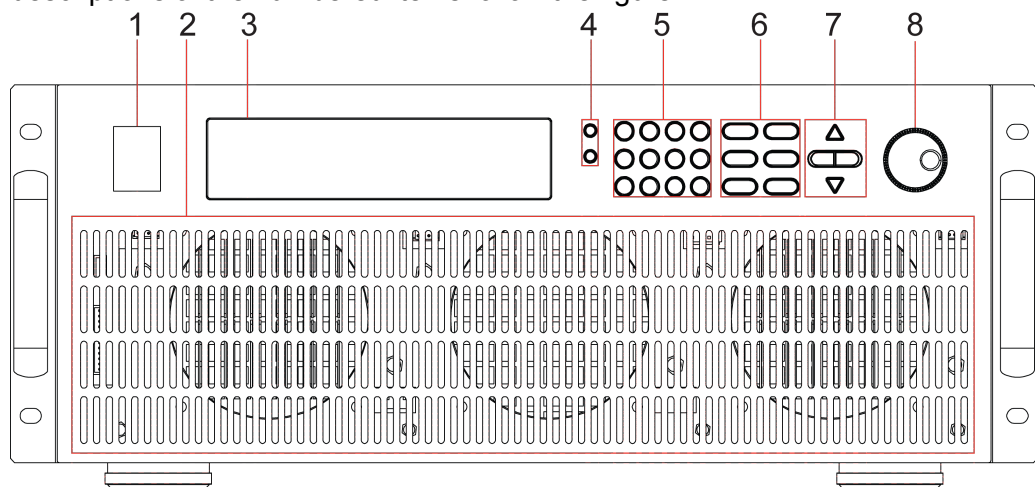

1. Power switch



2. Ventle hole
3. VFD screen
4. Shift and Local keys
5. Number key and composite key
6. Function keys
7. Up, Down, Left and Right key, to move cursor
8. Adjusting knob

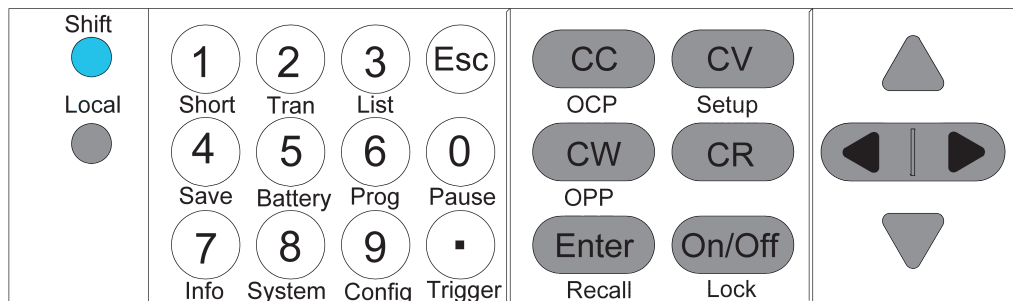

## 2.3 Keyboard Introduction

The keyboard is shown in the following figure; Descriptions of the key function follow the figure below.



Detailed description of keys.

Key Name	Description
[Shift]	[Shift] Composite key.
[Local]	[Local] key, To shift local and remote operation.
[0]~[9]	[0]~[9] are numeric keys.
.	Dot
[Esc]	[Esc] key, To exit at any working status.
[CC]	To select constant current mode and set current input value.
[CV]	To select constant voltage mode and set voltage input value.
[CR]	To select constant resistance mode and set resistance input value.
[CW]	To select constant power mode and set constant power input value.

Key Name	Description
[Enter]	[Enter] key.
[On/Off]	To control input status of load: on/off.
	Up/Down key, to select menu items during menu operation.
	Left/Right key, to adjust the cursor to the specified location to set the value.

## 2.4 Fast Function Key

A combination of front panel keys and **[Shift]** composition keys in IT8900A/E Series can realize functions marked at key bottom. For details, see table below.

Keys	Name and functions
[Shift]+[1] (Short)	To start or end short circuit test.
[Shift]+[2] (Tran)	To set dynamic operation parameters.
[Shift]+[3] (List )	To set list operation function.
[Shift]+[4] (Save)	To save existing setting load parameter values, e.g., voltage, current and power.
[Shift]+[5] (Battery)	To operate battery test function.
[Shift]+[6] (Prog)	To operate auto test function.
[Shift]+[7] (Info)	To display model, version number and serial number of electronic load.
[Shift]+[8] (System)	To set system menu.
[Shift]+[9] (Config)	To set configuration menu.
[Shift]+[0] (Pause)	To pause operation during automatic test.
[Shift]+[.] (Trigger)	Trigger key, to start up triggering functions.
[Shift]+[CC] (OCP)	To operate OCP test function.
[Shift]+[CV] (Setup)	To set specific parameters of constant voltage, constant current, constant resistance and constant power.

Keys	Name and functions
[Shift]+[CW] (OPP)	To operate OPP test function.
[Shift]+[Enter] (Recall)	To select stored load parameter values, e.g., voltage, current and power setting values.
[Shift]+[On/Off] (Lock)	To operate Keyboard locking function.

## 2.5 Function Description of VFD Status Indicators

IT8900A/E series VFD indicator lamps descriptions are as follows:

Flag	Function introduction	Flag	Function introduction
OFF	The load is off.	Error	The load has error.
CC	The load is under constant current mode.	Trig	The load is waiting for triggering signal.
CV	The load is under constant voltage mode.	Sen-se	The load is under remote sense input mode.
CR	The load is under constant resistance mode.	Prot	The load is under software over-current protection status.
CW	The load is under constant power mode.	Rear	Start external analog quantity function.
Rmt	The load is under remote operation mode.	Auto	Start automatic voltage range.
Addr	Send command under remote operation.	*	Start keyboard locking function
SR-Q	Serial request query.	Shift	Shift key is pressed.

## 2.6 Rear Panel Introduction

- Schematic Diagram of Rear Panel of IT8900A/E series (4U) electronic load.

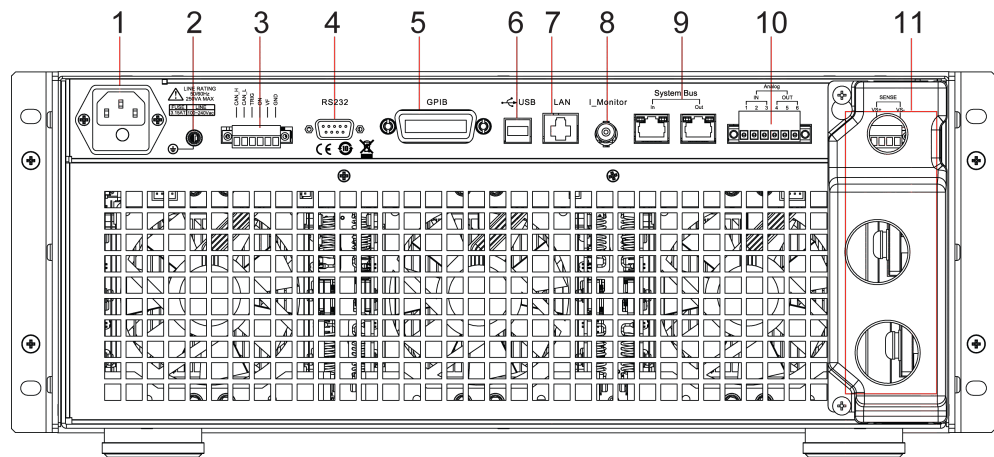

1. AC power input socket (including fuse)
  2. Ground terminal
  3. External signal control interface
  4. RS232 communication interface
  5. USB communication interface
  6. LAN communication interface
  7. GPIB communication interface
  8. SYSTEM BUS interface
  9. Current monitoring terminal
  10. External analog 0-10 V control terminal
  11. Remote sense compensation terminal and input terminal
- Schematic Diagram of Rear Panel of IT8900A/E series (8U) electronic load. IT8900A/E series (8U) consists of two electronic loads (4U). The electronic load (4U) with front panel is the master and the other is the slave.

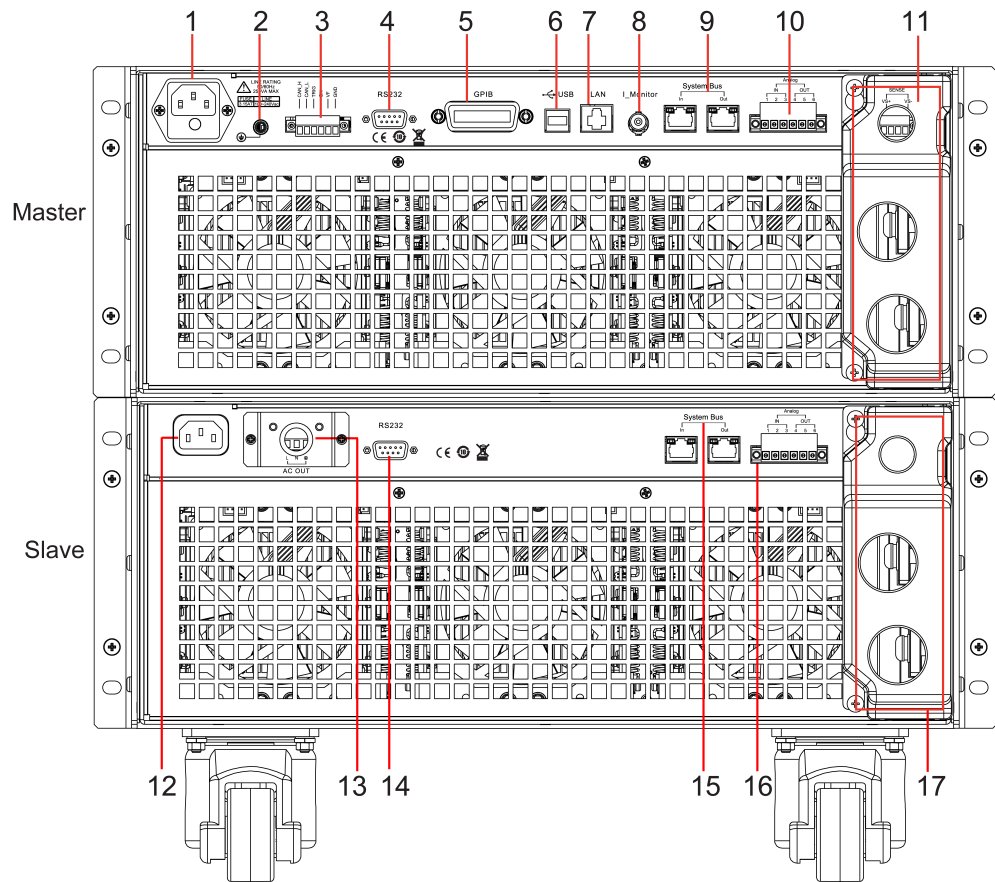

1. AC input socket of master, has been connected to AC OUT terminals of slave.
2. Ground terminal
3. External signal control interface
4. RS232 communication interface
5. USB communication interface
6. LAN communication interface
7. GPIB communication interface
8. SYSTEM BUS interface
9. Current monitoring terminal
10. External analog 0-10 V control terminal
11. Remote sense compensation terminal and input terminal
12. AC input socket of slave
13. AC OUT terminals of slave
14. RS-232 communication interface, used for slave calibration
15. SYSTEM BUS interface of slave, has been connected to SYSTEM BUS interface of master
16. Analog terminal of slave, has been connected to Analog terminal of master
17. Input terminal of slave, has been connected to Input terminal of master

- Schematic Diagram of Rear Panel of IT8900A/E series (15U) electronic load is shown as below, model 27U and model 37U have the same rear panels as 15U model. Only the sizes are different.

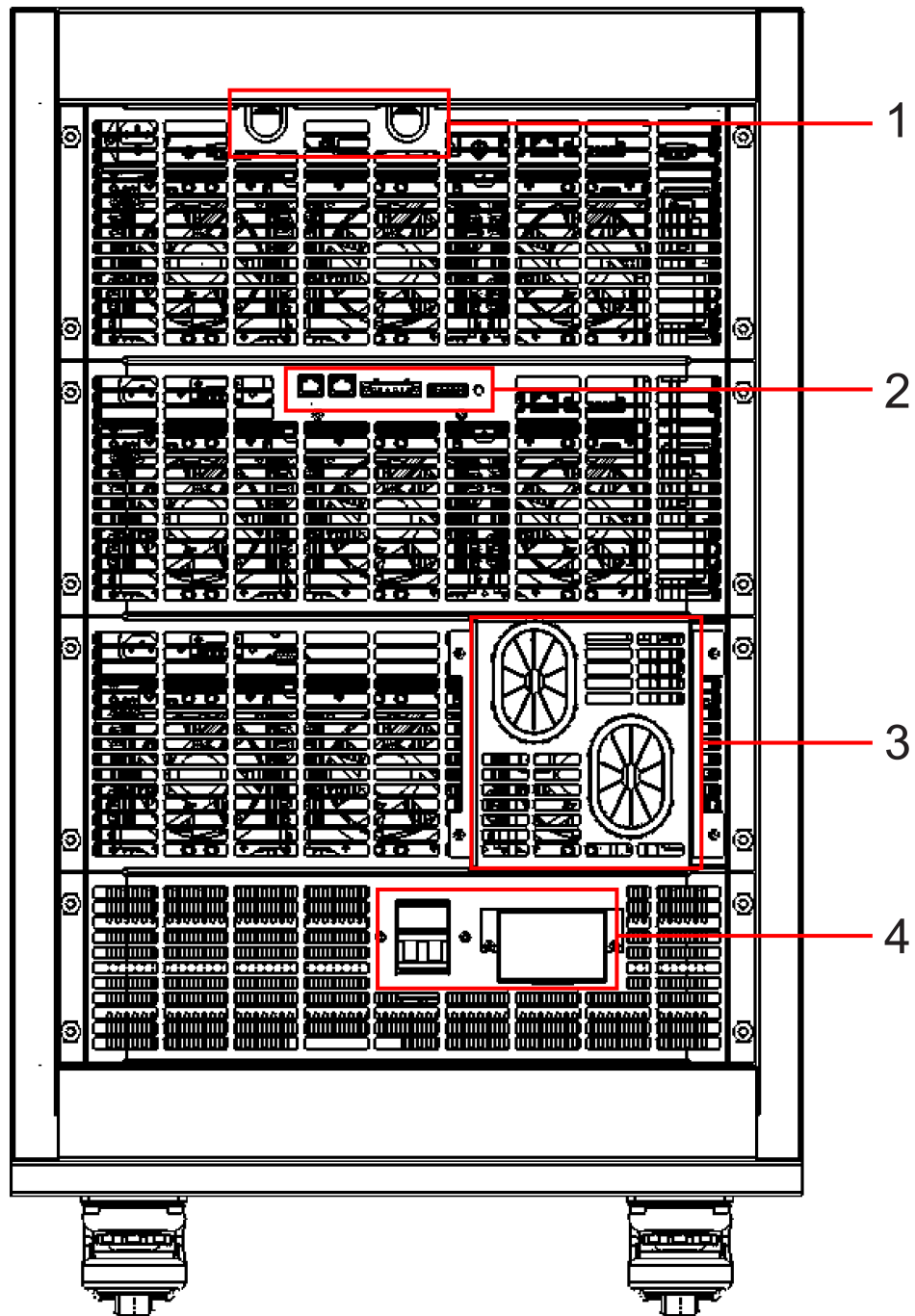

1. Threading hole for communication interface

To use the communication interface function , please remove this panel before connecting the terminals.

2. SYSTEM BUS interface, external analog control terminal, remote sense terminal and latch button SW.

You can switch the control state of the instrument between local control and remote control by using the latch button SW. Press the latch button SW to RP state, indicates the instrument is in the remote control. Press the latch button SW again to LP state, indicates the instrument is in local control.

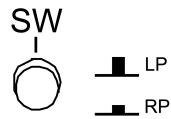

The latch button SW of the instrument which is in single mode must keep LP state.

3. Input terminal
  4. AC power switch and AC power input terminal
- Schematic Diagram of Rear Panel of IT8900A/E series (27U\*2) electronic load.

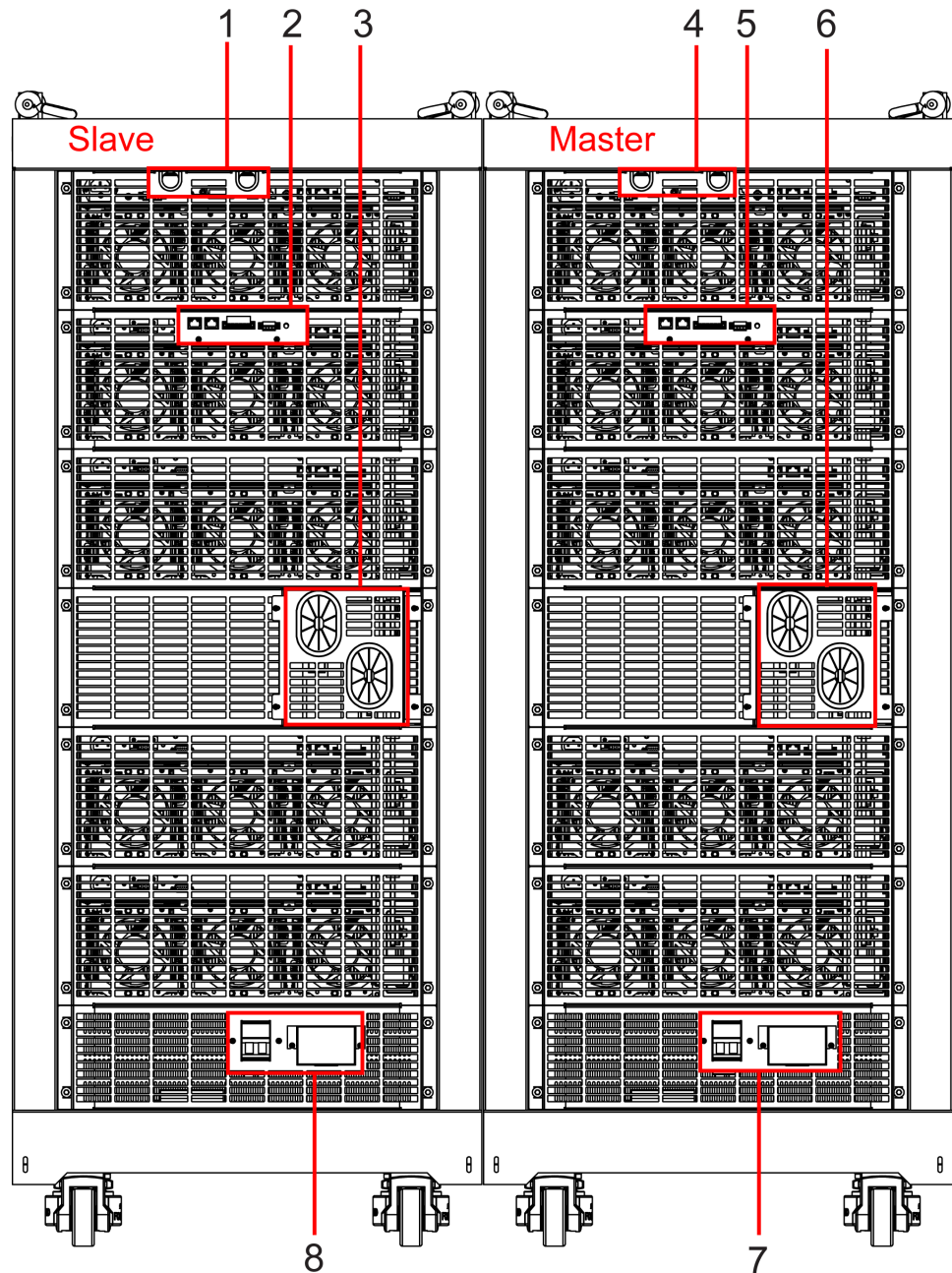

1. Threading hole for communication interface.

To use the communication interface function, please remove this panel before connecting the terminals.

2. Slave unit: SYSTEM BUS interface, external analog control terminal, remote sense terminal and latch button SW for slave.

You can switch the control state of the instrument between local control and remote control by using the latch button SW. Press the latch button SW to RP state, indicates the instrument is in the remote control. Press the latch button SW again to LP state, indicates the instrument is in local control.

SW

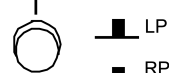



The latch button SW of the instrument which is in slave mode must keep RP state and the power-on switch of the slave instrument is recommended to keep ON state.

3. Slave load input terminals.
4. Threading hole for communication interface.

To use the communication interface function , please remove this panel before connecting the terminals.

5. Master unit: SYSTEM BUS interface, external analog control terminal, remote sense terminal and latch button SW for master.

The latch button SW of the instrument which is in master mode must keep LP state.

6. Master load input terminals.
7. Master unit: AC power switch and AC power input terminal for master.
8. Slave unit: AC power switch and AC power input terminal for slave.

## 2.7 Power-on Selftest

A successful selftest indicates that the purchased load product meets delivery standards and is available for normal usage. Before operation, please confirm that you have fully understood the safety instructions.

### WARNING

- **To avoid burning out, be sure to confirm that power voltage matches with supply voltage.**
- **Be sure to connect the main power socket to the power outlet of protective grounding. Do not use terminal board without protective grounding. Before operation, be sure that the electronic load is well grounded.**
- **To avoid burning out, pay attention to marks of positive and negative polarities before wiring.**

### Selftest Steps

Normal selftest procedures:

1. Correctly connect the power line. Press **[Power]** key to start up.  
The VFD screen displays the software version number  
BIOS Ver 1.10
2. After approximately 1s, the system starts conducting self-test and the VFD displays  
System Selftest...
3. After the self-test, the VFD displays information, as shown in the below.

0.00V            0.00A  
 0.0W            CC=0.00A

Information description:

- The first line displays actual input voltage and current values.
  - The second line displays actual power value and setting values of current (voltage, power and resistance).
4. Press **[Shift]+[7]**(Info), the VFD screen displays related information of the product, as shown below.  
 IT89XXX-XXXX-XXX  
 Ver:0.XX-0.XX-1.XX  
 SN:XXXXXXXXXXXXXXXXXXXX
  5. Press Up/Down key to switch between the display of product model, product serial number, and software version number.

### Error Information References

The following error information may occur when an error occurs during Power On self-test:

Error information	Error information explanation
Eeprom Failure	EEPROM Failure
CAL data lost	Calibration data is lost
Factory data lost	Factory data is lost
System data lost	System setting data is lost

### Exception handling

If the electronic load cannot start normally, please check and take measures by reference to steps below.

1. Check whether the power line is correctly connected and confirm whether the electronic load is powered.  
 Correct wiring of power line => 2  
 Incorrect wiring of power line => Re-connect the power line and check whether the exception is removed.
2. Check whether the power in On. **[Power]** key is under “ I” On status.  
 Yes => 3  
 No => Please check the **[Power]** key to start power and check whether the exception is removed.
3. Check whether set power voltage of electronic load is larger than the power supply voltage.

4. Check whether the fuse of the instrument is burned out.

If fuse is burnt out, replace the fuse with the same type and rating. The specification is 3.15AT/250V. Refer to [A.2 Fuse Replacement](#) for detailed replacement procedures.

# 3 Function and Features

This chapter describes in detail the use of the front-panel keys and shows how they are used to accomplish instrument operation. This chapter is divided into the following sections:

- ◆ Switching of Local/Remote Operation Modes
- ◆ Constant-status Operation Mode
- ◆ Input Control Function
- ◆ Keyboard Locking Function
- ◆ Short-circuit Analog Function
- ◆ System Menu Function(System)
- ◆ Configuration menu function (Config)
- ◆ Triggering Function
- ◆ Dynamic Test Function
- ◆ OCP Test Function
- ◆ OPP Test Function
- ◆ Battery discharge test function
- ◆ CR-LED test function
- ◆ Measure Function
- ◆ Configuration Save Function
- ◆ VON Function
- ◆ Protective Function
- ◆ List Operation
- ◆ Terminal Function of Rear Panel
- ◆ Auto Test Function
- ◆ Parallel Function

## 3.1 Switching of Local/Remote Operation Modes

The electronic load is provided with local and remote operation modes. These two modes can be switched through communication commands. At initialization, the electronic load is defaulted under local operation mode.

- Local operation mode: for operating related functions through keys on the electronic load machine.
- Remote operation mode: for operating related functions of the electronic load on PC through a connection between the electronic load and PC. Under remote operation mode, except **[Local]**key, other keys on the board are disabled. The **[Local]** key can be used for switching to local operation mode.

## 3.2 Constant-status Operation Mode

The electronic mode can work under the 4 constant-state operation modes:

- Constant current operation mode (CC)
- Constant voltage operation mode (CV)
- Constant resistance operation mode (CR)
- Constant power operation mode (CW)

### 3.2.1 Constant Current Operation Mode ( CC )

Under CC mode, the electronic load will consume constant current in regardless of whether the input voltage changes or not, as shown in the following figure.

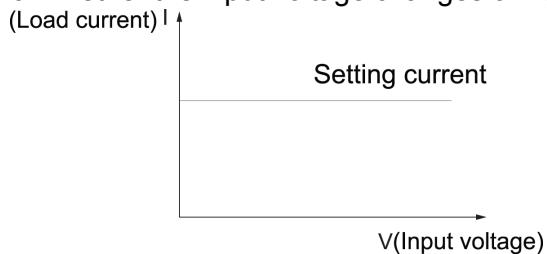

Under CC mode, the electronic load provides three ways to set constant current.

- Rotate adjusting knob to set constant current value.
- Use numeric keys to input current value and press **[Enter]** key to confirm set constant current value.
- Use Left/Right key moving cursor and press Up/Down key to adjust values at corresponding positions.

#### Operation steps

1. Press **[CC]** key and **[Shift]+[CV]**(Setup) to enter parameter setting screen.

```
Constant Current
Range=240.00A
```

2. Set maximum working current value and press **[Enter]** for confirmation.

```
Constant Current
Range =200.00A
```

3. Set maximum voltage value and press **[Enter]** key.

```
Constant Current
High=1205.0V
```

4. Set minimum voltage value and press **[Enter]** key.

```
Constant Current
```

Low=0.0V

- Set high and low rate and press **[Enter]** key.

Constant Current  
High-Rate Low-Rate

- Set ascending slope and press **[Enter]** key.

Constant Current  
Rise up=2.0000A/mS

- Set descending slope and press **[Enter]** key.

Constant Current  
Fall down=2.0000A/mS

- Complete parameter setting.

0.0V 0.00A  
0.0W CC=0.00A



#### Note

If the above method is for editing auto test step (as mentioned below), constant current range can also be set.

## 3.2.2 Constant Voltage Operation Mode ( CV )

Under CV mode, the electronic load will consume sufficient current to maintain the input voltage at setting voltage, as shown in the following figure.

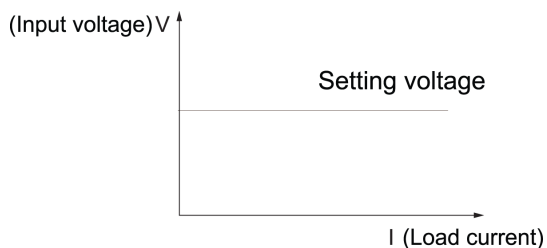

Under CV mode, the electronic load provides three ways to modify constant voltage.

- Rotate adjusting knob to set constant voltage value.
- Use numeric keys to input voltage value and press **[Enter]** key to confirm set constant voltage value.
- Use Left/Right key moving cursor and press Up/Down key to adjust values at corresponding positions.

### Operation Steps

- Press **[CV]** key and **[Shift]+[CV]**(Setup) to enter parameter setting screen.

Constant Voltage

Range=1200.0V

2. Set maximum working voltage value and press **[Enter]** for confirmation.

Constant Voltage

Range=1000.0V

3. Set maximum current value and press **[Enter]** key.

Constant Voltage

High=252.00A

4. Set minimum current value and press **[Enter]** key.

Constant Voltage

Low=0.00A

5. Set limited current value under CV mode and press **[Enter]** key.

Constant Voltage

I-Limit=240.00A

6. Set high and low rate and press **[Enter]** key.

Constant Voltage

High-Rate Low-Rate

7. Complete parameter setting.

0.0V                    0.00A

0.0W                    CV=1000.0V



#### Note

If the above method is for editing auto test step (as mentioned below), constant voltage range can also be set.

### 3.2.3 Constant Resistance Operation Mode ( CR )

Under CR mode, the electronic load is equivalent to a constant resistance (as shown below) and will give linear change of current with input voltage change, as shown in the following figure.

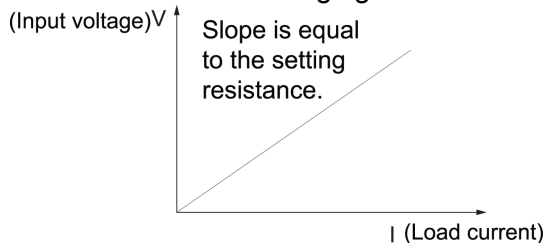

Under CR mode, the electronic load provides three ways to modify constant resistance.

- Rotate adjusting knob to set constant resistance value.
- Use numeric keys to input resistance value and press **[Enter]** key to confirm set constant resistance value.

- Use Left/Right key moving cursor and press Up/Down key to adjust values at corresponding positions.

### Operation Steps

1. Press **[CR]** key and **[Shift]+[CV]**(Setup) to enter parameter setting screen.

```
Constant   Resistance
Range=7500.0Ω
```

2. Set maximum working resistance value and press **[Enter]** for confirmation.

```
Constant   Resistance
Range =7000.0Ω
```

3. Set maximum voltage value and press **[Enter]** key.

```
Constant   Resistance
High=1205.0V
```

4. Set minimum voltage value and press **[Enter]** key.

```
Constant   Resistance
Low=0.0V
```

5. Set limited current value under CR mode and press **[Enter]** key.

```
Constant   Resistance
I-Limit=240.00A
```

6. Complete parameter setting.

```
0.0V      0.00A
0.0W      CR=7000.0Ω
```



#### Note

If the above method is for editing auto test step (as mentioned below), constant resistance range can also be set.

## 3.2.4 Constant Power Operation Mode ( CW )

Under CW mode, the electronic load will consume a constant power, as shown below. If input voltage rises, the input current decreases and power  $P (= V * I)$  will maintain at setting power, as shown in the following figure.

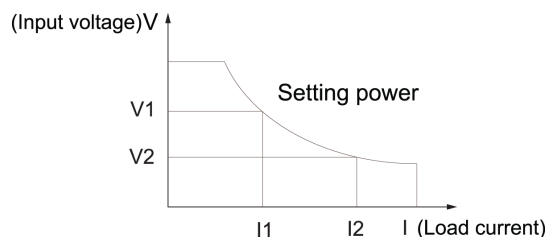

Under CW mode, the electronic load provides three ways to modify constant power.



- Rotate adjusting knob to set constant power value.
- Use numeric keys to input power value and press **[Enter]** key to confirm set constant power value.
- Use Left/Right key moving cursor and press Up/Down key to adjust values at corresponding positions.

## Operation Steps

1. Press **[CW]** key and **[Shift]+[CV]**(Setup) to enter parameter setting screen.

```
Constant   Power
Range=6000.0W
```

2. Set maximum working power value and press **[Enter]** for confirmation.

```
Constant   Power
Range =5000.0W
```

3. Set maximum voltage value and press **[Enter]** key.

```
Constant   Power
High=1205.0V
```

4. Set minimum voltage value and press **[Enter]** key.

```
Constant   Power
Low=0.0V
```

5. Set limited current value under CW mode and press **[Enter]** key.

```
Constant   Power
I-Limit=240.00A
```

6. Complete parameter setting.

```
0.0V      0.00A
0.0W      CW=0.0W
```



### Note

If the above method is for editing auto test step (as mentioned below), constant power range can also be set.

## 3.2.5 Compound Operation Mode

IT8900A series electronic load has four compound operation modes: CV+CC, CV+CR(CR-LED), CR+CC and CW+CC. These four compound operation modes add I-Limit ( limited current value) setting function under CV/CR/CW mode, which can help engineers solve the transient surge current problems, avoid to trigger the protection function and protect DUT from burning.

For example, in charging station test, the electronic load needs to rise up to 700V under CV mode. During test process, in order to stabilize electronic load

at 700V faster, the current value will suddenly increase too much due to the fast rising speed, which will cause the charging station into OCP status and stop outputting. To avoid the similar problems, we can use CV+CC mode to set a limited current value so that the internal current adjustment will be no more than the over-current protection level, which will avoid the surge current and solve the OCP problem in charging station. The common applications for the four compound operation modes are as follows.

- The CV+CC mode can be applied to the load simulation battery and test the charging station or the car charger. When the CV is working, the maximum loading current is limited.
- The CR+CC mode is commonly used in the testing of voltage limiting, current limiting characteristics, constant voltage accuracy, and constant current accuracy of on-board chargers, which prevents over-current protection of on-board chargers.
- The CW+CC mode is often used to UPS battery test, simulate the current change when the battery voltage is decaying. It can also be used to simulate the characteristics of the inputs of DC-DC converters and inverters.

The operation procedures for CV+CC compound mode is shown as follows. CR+CC and CW+CC compound modes are the same.

1. Press **[CV]** key to switch into CV mode. Press numeric keys to set the constant voltage value.

```
0.0V      0.00A
0.0W      CV=1000.0V
```

2. Press the **[Shift]+[CV]** (Setup) keys to enter the parameter setting page.

```
Constant Voltage
Range=1200.0V
```

3. Set the maximum working voltage value, and enter the **[Enter]** key.

```
Constant Voltage
Range=1000.0V
```

4. Press up and down keys to select "I-Limit=240.00A". Set the limited current value under CV mode and press **[Enter]** to confirm.

```
Constant Voltage
I-Limit=240.00A
```

5. Press **[Esc]** to exit setting.

### 3.3 Input Control Function

Control input switch of the electronic load by pressing **[On/Off]** key on the front board. If **[On/Off]** lamp is on, the input is on; and if **[On/Off]** lamp is off, the input is off. When the electronic load input is on, the VFD status indicator "OFF" is unlit.

## 3.4 Keyboard Locking Function

Press the composite key **[Shift]+[On/Off]**(Lock) to lock the instrument board key, and the VFD displays \*. Under this function statuses, except **[On/Off]** key and **[Shift]+[On/Off]**(Lock), other keys are disabled. Press this composite key to cancel locking.

## 3.5 Short-circuit Analog Function

The electronic load can analog a short circuit. On the front panel, press **[Shift]+[1]** to switch to the short circuit mode. The short circuit mode does not influence the existing settings. When the short-circuit analog is turned off, the instrument returns to the previous setting status.

In the short circuit mode, the current value is determined by the operation mode and the current range. Under CC, CW and CR modes, maximum short-circuit current is 110% of the current range. Under CV mode, short-circuit current equals to current when constant voltage is 0 V.

## 3.6 System Menu Function(System)

Press **[Shift]+[8]**(System) to enter system menu setting.

Initialize	INITIALIZE SYSTEM?		
		NO	Keep existing configurations.
		YES	Recover all configurations to factory set values.
Power-On	POWER ON		
		Rst(Def)	Set the input status of load at powering on as "status as delivered".
		Sav0	Set the input status of load at powering on as SAVE 0 value.
Buzzer	BUZZER STATE		Set the buzzer status.
		Off	Set the buzzer as OFF status.
		On(default)	Set the buzzer as ON status.
Knob	LOAD ON KNOB MODE		Set the pulse knob.
		Update(default)	Real-time update.
		Old	No update (Recover to original value at ON/OFF).

Trigger	TRIGGER SOURCE		Set triggering mode.
		Manual(Def)	Manual trigger.
		External	External signal trigger mode.
		Hold	Trig: IMM valid.
		Bus	GPIB bus trigger mode.
		Timer	Timer trigger mode.
			Timer=1.00S
Memory	MEMORY		Work with Recall button to recall 100 sets saved parameters.
		Group= ( 0-9 )	0: represents 1-10 sets; 1: represents: 11-20 sets, by parity of reasoning.
Displ	DISPLAY ON TIMER		Screen displays loading time.
		Off(default)	Stop function.
		On	Start function.
Communciation	COMMUNICATION		Select the interface for communication with a computer.
		RS232	Select the RS232 communication interface.
			Set baud rate: 4800/9600/19200/38400 /57600/115200
			Set data bit: 8
			Set parity check bit: N
			Set stop bit: 1
			Set handshake protocol: NONE
		USBTMC	Select the USB communication interface.
		GPIB	Select the GPIB communication interface, Address(0-31)
		LAN	Select the LAN communication interface.
			Gateway= 192.168.0.1
			IP= 192.168.0.125
			Mask= 255.255.255.0
			Socket Port= 30000
Parallel	PARALLEL SETUP		Parallel mode set up.
		Single	Single mode.
		Slave	Act as a slave mode.
		Master	Act as a master mode.

		Total = 3	Set total number of instruments in parallel.
--	--	-----------	--

### 3.6.1 Restored to Factory Setting(Initialize)

This option is used to restore all settings in the system menu to factory setting values.

1. Press the composite key **[Shift]+[8]**(System) to enter system menu setting screen.
2. Operate Left/Right key and move to the Initialize and press **[Enter]** key.
3. Select "YES" and Press **[Enter]** to restore to factory setting values. In this case, all set values in the system will be restored to factory setting values, i. e., the (Def) mark values.

### 3.6.2 Power On Parameter(Power-On)

This parameter determines the state of electronic load after power up. If you select "Rst", the default input parameter settings will be active after power up. If you select "Sav 0", then the electronic load will automatically recall the input parameters setting saved in 0 register.

### 3.6.3 Key Sound Set(Buzzer)

This item can set the buzzer state. On option indicates that when you push buttons, the buzzer will sound. Off option indicates that the buzzer function is disabled. Factory default is On option.

1. Press the composite key **[Shift]+[8]**(System) to enter system menu setting screen.
2. Operate Left/Right key and move to the Buzzer and press **[Enter]** key.
3. Select On or Off to change the buzzer status.

### 3.6.4 Rotary Knob Set(Knob)

This item is used to set rotary knob state. In Update mode, you can use this rotary knob to set the input value . Rotate the knob clockwise to increase the set value and anticlockwise to decrease the set value. In Old mode, this knob can't be used. Factory default is Update option.

1. Press the composite key **[Shift]+[8]**(System) to enter system menu setting screen.
2. Operate Left/Right key and move to the Knob and press **[Enter]** key.

3. Select Update or Old to change the knob setting.

### 3.6.5 Trigge Mode(Trigger)

Triggering function is necessary to operate dynamic pulse output and list output. There are five kinds of trigger options: Manual, External, Hold, Bus and Timer

1. Press the composite key **[Shift]+[8]**(System) to enter system menu setting screen.
2. Operate Left/Right key and move to the Trigger and press **[Enter]** key.
3. Press Left/Right key to select trigger method and press **[Enter]** to complete setting.
  - Manual (Def): manual trigger
  - External: external signal trigger
  - Hold: special command trigger
  - Bus: BUS command trigger
  - Timer: timer trigger

### 3.6.6 Set Memory Group(Memory>Group)

The electronic load can save some commonly-used parameters in 100-group NVM for convenient and fast usage. The **[Shift]+[4]**(Save) keys can be used for saving parameters. The **[Shift]+[Enter]**(Recall) key is for quick invoking.

When you want to recall the data saved in the memory, you should set memory group in the system menu first. Group 0 means you can recall data saved in 0 to 10 groups. Group 1 means you can recall data saved in 11 to 20 groups. Group2 to Group 9 can be concluded in the same manner. The operation procedures for setting Group number is shown as follows.

1. Press the composite key **[Shift]+[8]**(System) to enter system menu setting screen.
2. Operate Left/Right key and move to the Memory and press **[Enter]** key.
3. Press numeric keys to set Group number.

### 3.6.7 Loading Time Display Set(Displ)

This menu item can set if the main screen displays the loading time or not. If On is selected, the main screen displays the loading time. If Off is selected, the loading time will not be displayed. Factory default is Off option.

1. Press the composite key **[Shift]+[8]**(System) to enter system menu setting screen.

2. Operate Left/Right key and move to the Dspl and press **[Enter]** key.
3. Operate Left/Right key and move to the On and press **[Enter]** key. The screen will display the loading time.

### 3.6.8 Communication Set

Under this item, you can set the specific communication mode. This unit has provided multiple communication interfaces: RS232/USB/GPIB/LAN. You can choose any one of them to communicate.

1. Press **[Shift]+[8]**(System) to enter system menu setting.
2. Press Left/Right key to select “Communication”. Press **[Enter]** key.
3. Press left or right keys to select communication interface: RS-232/USBTMC/GPIB/LAN.

Please ensure the configuration consistency between our instrument and PC, so that you could have a successful communication.

- To select RS232 communication mode, you need to configure the baud rate 4800/9600/19200/38400/57600/115200, data bit 8 bits, parity bit N and stop bit 1 bit.
- To select the GPIB communication method, you need to configure the address. The address setting range is 0-31.
- To select the LAN communication method, you need to configure the gateway address, IP address, mask address and socket port.

## 3.7 Configuration menu function (Config)

Press **[Shift]+[9]**(Config) to enter menu configuration(Config Menu).

Von	VOLTAGE ON	Set the load's von point	
	Living	Von point living state, ON /OFF	
		Point= 0.00V	Set the Von value.
	Latch	Von point latch state, ON /OFF	
		Point= 0.00V	Set the Von value.
Protect	PROTECT MENU		
	Max-P	Set hardware power protection.	
		MAX POWER	
		Point=2000.0W	Set hardware protective power value.
	I-Limit	Set software current protection.	
		CURRENT LIMIT	

		Off	Stop function.
		On	Start function.
		Point=240.00A	Set software current protective value.
		Delay= 3S	Set software current protective delay.
	P- Limit	Set software power protection.	
		POWER LIMIT	
		Point=2000.0W	Set software power protective value.
		Delay= 3S	Set software power protective delay.
	Timer	Set LOAD ON timer.	
		ON-TIMER	
		Off	Stop function.
		On	Start function.
		ON-TIMER	
		Delay=10.00S	Set LOAD ON timer value.
	OSC	Set current oscillation protection	
		Off	Stop function.
		On	Start function.
Measure	MEASURE MENU		
	V-Range	Auto switch function of voltage range.	
		VOLTAGE AUTO RANGE	
		On	Start auto voltage range.
		Off	Stop auto voltage range.
	Time V	Measure voltage rise/fall time.	
		TIMER VOLTAGE FUNC	
		Low	Set low voltage value.
		Point1=0.00V	
		High	Set high voltage value.
		Point2=1200.0V	
	Time C	Measure current rise/fall time.	
		TIMER CURRENT FUNC	
		Low	Set low current value.
		Point1=0.000A	



		High	Set high current value.
		Point2=100.00A	
	Filter	Smoothing function.	
		Average Count=2 <sup>2</sup> (2~16)	Set of average count.
CR-LED	CR LED MODE	Analog LED lamp function (under CR mode).	
	On	Start CR-LED function.	
	Off	Stop CR-LED function.	
Remote-Sense	REMOTE SENSE STATE	Remote sense compensation measurement.	
	Off	Stop remote sense compensation function.	
	On	Start remote sense compensation function.	
Ext-Program	EXTNAL PROGRAM	External analog quantity function.	
	Off	Stop external 0-10 V analog quantity control function.	
	On	Start external 0-10 V analog quantity control function.	
Enhance Power	Enhance Power	Transient over power loading capability	
	Off	Stop function.	
	On	Start function.	

### 3.7.1 On-Timer Set(Protect>Time)

This menu item can set the load-on timer for the electronic load. When On is selected, turn the input on, and then the electronic load will automatically turn the input off until the setting time runs out. When Off is selected, the load-on timer function is off.

1. Press **[Shift]+[9]**(Config) to enter configuration menu(Config Menu).
2. Press Left/Right key to select "Protect". Press **[Enter]** key.
3. Press Left/Right key to select "Time". Press **[Enter]** key.
4. Press Left/Right key to select "On". Press **[Enter]** key.
5. Set value of load-on timer (i.e. "Delay"), and press **[Enter]** to confirm.

### 3.7.2 Auto-Switching Voltage Range Set(Measure>V-Range)

This menu item is used to set the voltage range to auto-switch. When On is selected, the instrument will automatically switch to high range or low range. When Off is selected, the auto-switching voltage range function is disabled.

1. Press **[Shift]+[9]**(Config) to enter configuration menu(Config Menu).
2. Press Left/Right key to select "Measure". Press **[Enter]** key.
3. Press Left/Right key to select "V-Range". Press **[Enter]** key.
4. Press Left/Right key to select "On". Press **[Enter]** key.

### 3.7.3 Setting Filter(Measure>Filter)

This option sets the display filter frequency of the load. The filter function of this series of load is averaging calculation.

1. Press **[Shift]+[9]**(Config) to enter configuration menu(Config Menu).
2. Press Left/Right key to select "Measure". Press **[Enter]** key.
3. Press Left/Right key to select "Filter". Press **[Enter]** key.
4. Set the filter frequency value (i.e. "Average Count"), and press **[Enter]** to confirm.

### 3.7.4 Set transient over power loading capability(Enhance Power)

This option is used to set transient over-power loading capability. Selecting On means turning the transient over-power loading capability function on. Selecting Off represents that the function is disabled.

Transient over power loading capability, it will make IT8900A series load to take 1.1 to 2 times the rated power loading capability in short time, users don't need to select types as maximum power value, it can extremely save cost. This function can be widely applied into the DUT transient peak power supply ability.

To ensure that the transient over-power loading capability function can work normally, please obey the following precautions.

**WARNING**

- **The transient over-power loading capability function is valid in case that the electronic load detects the internal temperature is less than 30 °C . When the loading power is 2 times the rated power, the load input voltage cannot be too large, and the input voltage conditions of different models are different.**
- **When the loading power is over 1.1 times the rated power, the loading time must be limited within 3 seconds.**
- **The transient over-power loading capability function only works once, i.e., you need to reset this function in the configuration menu after turning the input on and off.**
- **The interval between the two over-power loading running must be up to 60 seconds.**
- **When the loading power is over 1.1 times the rated power, the fan runs at full power.**

Refer to the following procedures to turn the transient over-power loading capability function on.

1. Press **[Shift]+[9]**(Config) to enter menu configuration(Config Menu).
2. Press Left/Right key to select “Enhance Power”. Press **[Enter]** key.
3. Press Left/Right key to select “On”. Press **[Enter]** key.

## 3.8 Triggering Function

Triggering function is necessary to operate dynamic pulse output and list output. There are five triggering methods to trigger the tested instrument. Optional triggering sources of triggering function of electronic load comprise:

- **Key trigger:** when key trigger is valid, press **[Shift]+[.]** (Trigger) key and the load will trigger an operation.
- **External trigger signal (TTL):** Trig on the rear board is the triggering input terminal. When external trigger signal method is effective, after applying a low pulse (>10 us), the load will trigger an operation.
- **Bus trigger:** when the bus trigger is valid, after the load receives a trigger command (GET or \* TRG), the load will trigger an operation.
- **Timing trigger:** when the timing trigger is valid, the load will automatically trigger an operation at intervals.
- **Trigger holding:** when trigger holding is valid, only when the load receives trigger command (TRIG:IMM), the load will trigger an operation.

Select the triggering sources as follows:

1. Press **[Shift]+[8]**(System) to enter system menu setting screen.

SYSTEM MENU

Initialize Power-On Buzzer

2. Press Left/Right key to move to the Trigger and press **[Enter]** to enter triggering source selection screen.

TRIGGER SOURCE

Manual (Def) External Hold

3. Press Left/Right key to select trigger method and press **[Enter]** to complete setting.

Manual (Def): manual trigger

External: external signal trigger

Hold: special command trigger

Bus: BUS command trigger

Timer: timer trigger

4. Press **[Esc]** to exit setting. The system displays original values under different modes.

## 3.9 Dynamic Test Function

Through dynamic test operation, the electronic load can be switched between two setting parameters based on setting rules. This function can be used to test dynamic performances of power supply. For dynamic test operation, press **[Shift] + [2]** (Tran) key on the front board to enter the dynamic test menu. Before test, firstly, set parameters related to dynamic test operation, including dynamic test mode, A value, B value, pulse width time, frequency, duty ratio, etc. Under CC mode, current ascending and descending slopes should be set for dynamic test.

The dynamic test mode can be divided into continuous mode, pulse mode and toggle mode.

### 3.9.1 Continuous Mode

Under continuous mode, after enabling dynamic test operation, the load will be switched continuously between A value and B value.

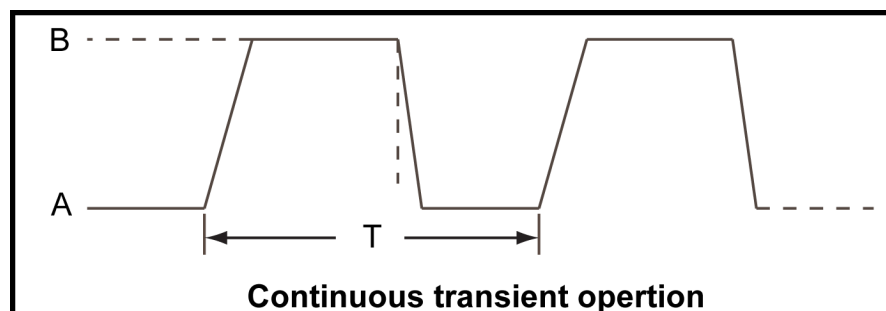

Taking CC mode as example (operations under other modes are similar), when output voltage and current of the tested instrument are 10 V and 3 A respectively, the load current will switch from 1 A and 2 A. Set the dynamic test parameters and perform the test as follows:

1. Press **[CC]** key to switch the load mode into CC mode.
2. Press **[Shift]+[2]**(Tran) keys. Operate Left/Right key and move to On. Press **[Enter]** key (The Trig lamp that indicates VFD screen status is on).

```
TRANSITION
On    Off
```

3. Operate Left/Right key and select Continuous. Press **[Enter]** for confirmation.

```
CONTINUOUS
Continuous Pulse Toggle
```

4. Operate Left/Right key and select high rate or low rate. Move to the High-Rate and press **[Enter]** key.

```
TRANSITION
High-Rate    Low-Rate
```

5. Set ascending slope and press **[Enter]** key.

```
TRANSITION
Rise up=2.0000A/uS
```

6. Set descending slope and press **[Enter]** key.

```
TRANSITION
Fall Down=2.0000A/uS
```

7. Set A value and press **[Enter]** key.

```
TRANSITION
Level A=1.00A
```

8. Set B value and press **[Enter]** key.

```
TRANSITION
Level B=2.00A
```

9. Set frequency value and press **[Enter]** key.

```
TRANSITION
Frequency=50.00HZ
```

10. Set duty ratio and press **[Enter]** key.

```
TRANSITION
Duty=50.00% (0.01%-99.99%)
```

11. Start dynamic test and operate Left/Right key. Move to On and press **[Enter]** key.

```
TRANSITION
On    Off
```

12. Enter the dynamic test mode.

```
0.00V      0.00A
0.0W      0 TRAN
```

13. Press **[On/Off]** key to open input and press **[Shift]+[.]**(Trigger).

The load will continuously switch between A and B value. Time of operations is shown at bottom right.



#### Note

After the running count is up to 65535, it goes to zero and re-count, which doesn't affect the normal running of dynamic test.

14. Press **[CC]/[CV]/[CR]/[CW]** key or any composite function key to exit dynamic test function. Repeat Steps 1-13 to continue parameter setting and operation of dynamic test.

## 3.9.2 Pulse Mode

Under pulse mode, after enabling dynamic test operation, the load will switch to A value after receiving of a trigger signal. Then the load will switch back to B value and be constant at B value after maintaining A for pulse width time.

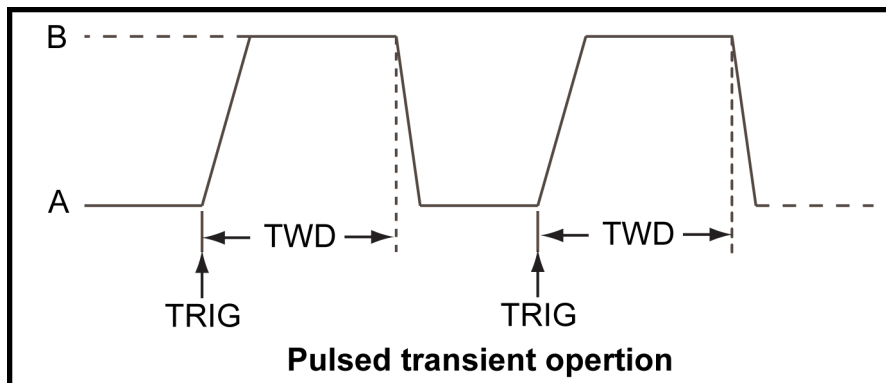

Taking CC mode as example (operations under other modes are similar), when output voltage and current of the tested instrument are 10 V and 3 A respectively, the load current will switch from 1 A and 2 A. Set the dynamic test parameters and perform the test as follows:

1. Press **[CC]** key to switch the load mode into CC mode.
2. Press **[Shift]+[2]**(Tran) keys. Operate Left/Right key and move to On. Press **[Enter]** key (The Trig lamp that indicates VFD screen status is on).

```
TRANSITION
On      Off
```

3. Operate Left/Right key and select Pulse. Press **[Enter]** for confirmation.

```
TRANSITION
Continuous Pulse Toggle
```

4. Operate Left/Right key and select high rate or low rate. Move to the High-Rate and press **[Enter]** key.

```
TRANSITION
High-Rate      Low-Rate
```

5. Set ascending slope and press **[Enter]** key.

```
TRANSITION
Rise up=2.0000A/uS
```

6. Set descending slope and press **[Enter]** key.

```
TRANSITION
Fall Down=2.0000A/uS
```

7. Set A value and press **[Enter]** key.

```
TRANSITION
Level A=1.00A
```

8. Set B value and press **[Enter]** key.

```
TRANSITION
Level B=2.00A
```

9. Set time width and press **[Enter]** key.

```
TRANSITION
Pulse Width=5.00000S
```

10. Start dynamic test and operate Left/Right key. Move to On and press **[Enter]** key.

```
TRANSITION
On      Off
```

11. Enter the dynamic test mode.

```
0.00V      0.00A
0.0W      0 TRAN
```

12. Press **[On/Off]** key to open input and press **[Shift]+[.]**(Trigger) key.

The load will switch after receipt of every trigger signal. The load will continuously switch between A and B value. Time of operations is shown at bottom right.

13. Press **[CC]/[CV]/[CR]/[CW]** key or any composite function key to exit dynamic test function.



Repeat Steps 1-12 to continue parameter setting and operation of dynamic test.

### 3.9.3 Toggle Mode

Under toggle mode with dynamic test function enabled, the load switches between A value and B value upon receiving a trigger signal, as shown in the following figure.

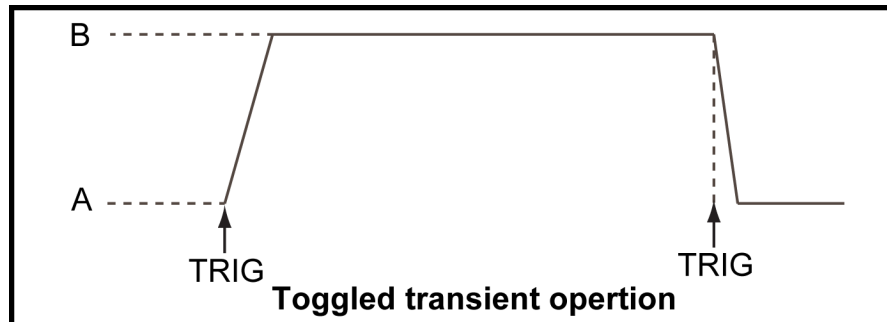

Taking CC mode as example (operations under other modes are similar), when output voltage and current of the tested instrument are 10 V and 3 A respectively, the load current will switch from 1 A and 2 A. Set the dynamic test parameters and perform the test as follows:

1. Press **[CC]** key to switch the load mode into CC mode.
2. Press **[Shift]+[2]**(Tran) keys. Operate Left/Right key and move to On. Press **[Enter]** key (The Trig lamp that indicates VFD screen status is on).

```
TRANSITION
On      Off
```

3. Operate Left/Right key and select Toggle. Press **[Enter]** for confirmation.

```
TRANSITION
Continuous Pulse Toggle
```

4. Operate Left/Right key and select high rate or low rate. Move to the High-Rate and press **[Enter]** key.

```
TRANSITION
High-Rate Low-Rate
```

5. Set ascending slope and press **[Enter]** key.

```
TRANSITION
Rise up=2.0000A/uS
```

6. Set descending slope and press **[Enter]** key.

```
TRANSITION
Fall Down=2.0000A/uS
```

7. Set A value and press **[Enter]** key.

```
TRANSITION
Level A=1.00A
```

8. Set B value and press **[Enter]** key.

```
TRANSITION
```



Level B=2.00A

- Start dynamic test and operate key. Move to on and press **[Enter]** key.

TRANSITION

On Off

- Enter the dynamic test mode.

0.00V 0.00A

0.0W 0 TRAN

- Press **[On/Off]** key to open input and press **[Shift]+[.]**(Trigger) key.

The load will switch after receipt of every trigger signal. The load will switch between A and B value for one time. Time of operations is shown at bottom right.

- Press **[CC]/[CV]/[CR]/[CW]** key or any composite function key to exit dynamic test function.



#### Note

Repeat Steps 1-11 to continue parameter setting and operation of dynamic test.

## 3.10 OCP Test Function

The IT8900A/E series electronic load is provided with over-current protection test function (OCP Test). Under OCP test mode, when input voltage reached Von value, delay for a while for the electronic load to latch. Ascend value by step value at regular interval. At the same time, check the load input voltage and judge whether it is higher than standard voltage value. If higher, it indicates that OCP does not occur. Repeat current stepping operation till the load operates to the cutoff current; if lower, it indicates that OCP does occur. Check whether the existing current value is within target scope again. If yes, PASS the test.

Operating steps:

- Press **[Shift]+[CC]**(OCP) keys to enter OCP test function setting screen.

OCP TEST	Run	OCP TEST	
			Operate OCP test documents.
	Recall	OCP TEST	
		Recall OCP File=1	Recall OCP test documents (1-5).
	Edit	OCP TEST	
		1 : Voltage on level=0.00V	Set Von voltage value.
2 : Voltage on Delay=0.00S		Set Von voltage delay time.	

	3 : Current Range=0.000A	Set working current range.
	4 : Start Current=0.000A	Set initial current value.
	5 : Step Current=0.000A	Set step current value.
	6 : Step Delay=0.00S	Set step delay time.
	7 : End Current=0.000A	Set cutoff current value.
	8 : OCP Voltage=0.000V	Set OCP value.
	9 : Max Trip Current=0.000A	Set overcurrent range (maximum value).
	10 : Min Trip Current=0.000A	Set overcurrent range (minimum value).
	Save OCP File=1 ( 1-5 )	Save OCP test documents.

- Press **[Shift]+[.]**(Trigger) key to start OCP test. If within range, pass the test and the board will display as follows:

```

9.97V          0.005A
0.010W   5.100A Pass  Stop
    
```

If not, there is FAULT and the board will display as follows:

```

9.97V          0.005A
0.010W   5.100A Fault Stop
    
```

- End test. Press **[Esc]** to return to setting screen. Press **[Esc]** again to exit.

## 3.11 OPP Test Function

The IT8900A/E series electronic load is provided with overpower protection test function (OPP Test). Under OPP test mode, when input voltage reached Von value, delay for a while for the electronic load to latch. Ascend value by step value at regular interval. At the same time, check the load input voltage and judge whether it is higher than standard voltage value. If higher, it indicates that OPP does not occur. Repeat power stepping operation till the load operates to the cutoff power; if lower, it indicates that OPP does occur. Check whether the existing power value is within target scope again. If yes, PASS the test.

Operating steps:

- Press **[Shift]+[CW]**(OPP) keys to enter OPP test function setting screen:

OPP TEST	Run	OPP TEST	
			Operate OPP test documents.
	Recall	OPP TEST	
		Recall OPP File=1	Recall OPP test documents (1-5).

	Edit	OPP TEST	
		1 : Voltage on level=0.00V	Set Von voltage value.
		2 : Voltage on Delay=0.00S	Set Von voltage delay time.
		3 : Current Range=0.000A	Set current range.
		4 : Start Power=0.00W	Set initial power value.
		5 : Step Power=0.00W	Set step power value.
		6 : Step Delay=0.00S	Set step delay time.
		7 : End Power=0.00W	Set cutoff power value.
		8 : OPP Voltage=0.000V	Set OPP value.
		9 : Max Trip Power =0.00W	Set overpower range ( maximum value).
		10 : Min Trip Power =0.00W	Set overpower range ( minimum value).
		Save OPP File=1 ( 1-5 )	Save OPP test documents.

- Press **[Shift]+[.]**(Trigger) key to start OPP test. If within range, pass the test and the board will display as follows:

```

9.97V          0.007A
0.010W   49.1W Pass Stop
    
```

If not, there is FAULT and the board will display as follows:

```

9.99V          0.007A
0.01W   48.6W Fault Stop
    
```

- End test. Press **[ESC]** to return to setting screen. Press **[ESC]** again to exit.

## 3.12 Battery discharge test function

In the IT8900A/E series electronic load, constant current mode is applied for discharge test with programmatic setting of stop voltage/capacity/discharging time. If stop voltage is set as the stop condition, the system determines whether the battery is about to reach the set threshold value or unsafe status when the battery voltage is low, and if yes, an automatic stop will be activated. During test, the operator can observe voltage, discharging time and discharged capacity of battery. Battery discharge test is a necessary step before battery replacement for it can reflect reliability and remaining life of battery.

- Press **[On/Off]** key to cut off load input status. Connect the battery to be tested.
- Press **[CC]** key to switch the load mode into CC mode.
- Press **[Shift]+[5]**(Battery) keys to enter battery discharge function menu.

4. Set stop voltage and press **[Enter]** key.

Stop Voltage=0.0V

When the battery voltage drops to stop voltage, the load input status will automatically be Off.

5. Set battery stop capacity and press **[Enter]** key.

Stop Capacity=0.000Ah

When set battery capacity is reached, the load input status will automatically be Off.

6. Set discharge time and press **[Enter]** key.

Stop Timer=99999S

When the set stop time is reached, the load input status will automatically be Off.

7. Press **[Shift]+[.]**(Trigger) key to start test. The board will display discharge voltage, current discharge time and discharged capacity (Ah).

0.01V                      0.00A

0.00W              0S 0.000Ah

8. Press **[Esc]** key to exit battery capacity test mode.

### 3.13 CR-LED test function

With adding of diode break-over voltage setting in the IT8900A series electronic load under conventional CR mode, the electronic load only works when voltage applied at its both ends is higher than the diode break-over voltage to give a real simulation of diode working principle, i.e., the ripple current at real LED test.

The I-V curve of LED is as shown below. Under conventional CR mode, the electronic load only simulates the static working point of diode as shown in the red circle of the following figure. It is unable to verify the dynamic characteristics of LED under normal working conditions, and the status of accurate ripple current.

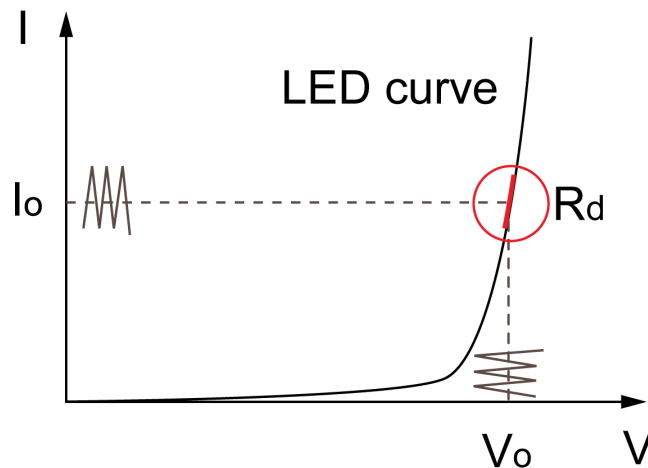

The definitions of parameters shown in the above figure are as follows:

- $V_o$ : constant working voltage of load LED of LED constant current source;
- $I_o$ : output current of LED constant current source;
- $V_d$ : break-over voltage of diode (string);
- $R$ : constant resistance.

## Setting CR-LED Mode

Example: LED driver specification

The output current is 200mA and the range of output voltage is from 45V to 62V.

1. Start CR-LED function.
  - a. Press **[Shift]+[9]**(Config) keys to enter configuration menu.
  - b. Press Right Key and select "CR-LED". Press **[Enter]** key for entry. Select "on" and press **[Enter]** key.
  - c. Press **[Esc]** key to exit.
2. Set CR mode and  $V_d$  value.

For example, the output voltage of LED driver is 50V, verify that whether the output current of LED is rated current 200mA.

- a. Press **[CR]** key and set corresponding constant resistance. (Set CR=50 $\Omega$ )
- b. Press **[Shift]+[CV]**(Setup)keys for a series of related setting:
 

```
range=7500.0
high=130V
low=0V
```

 which may remain the original values.  $V_d$  will be set based on the calculation below. (Set  $V_d=40V$ )
- c. Press the **[Enter]** key to save the settings.
3. Press **[On/Off]** key to turn on load input.

## Calculation method of $V_d$ and $R$

Definition:

- $V$ : constant working voltage of load LED of LED constant current source;
- $I$ : output current of LED constant current source;
- $V_d$ : break-over voltage of diode (string);
- $R$ : constant resistance.

V-I curve of LED is as shown below.

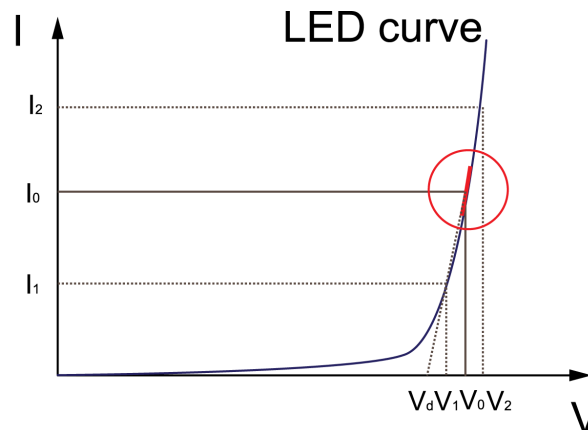

According to four parameters above and the V-I curve of LED, you can calculate the value of  $R$  and  $V_d$ .

$$R = \frac{V_2 - V_1}{I_2 - I_1}$$

$$V_d = V_0 - (I_0 \times R)$$



### Note

The value of  $V_2$ ,  $V_1$ ,  $I_2$  and  $I_1$  should be close to the static working point of LED as shown in the red circle above.

Or you can calculate the value of  $R$  and  $V_d$  by the following method.

$$V_d = V \times 0.8$$

$$R = 0.2V / I$$

In the example:

$$V_d = 50V \times 0.8 = 40V$$

$$R = (0.2 \times 50V) / 0.2A = 50\Omega$$

## 3.14 Measure Function

IT8900A/E series provide measure function, mainly used for measuring the rising and falling time of voltage or current within a specified range.

### Operation methods

1. Connect the instruments.  
Connect DC power to be tested to the input terminal of the electronic load.
2. Set the output parameters of the power supply.
  - a. The power is set with a value that is higher than the set high voltage/current value.
  - b. Keep power output in Off status.
3. Set the low and high voltage/current comparison points' value for electronic load.
  - a. Press **[Shift]+ [9]**(Config) keys to enter configuration menu. Press Right key. Select "Measure" and press **[Enter]** key.
  - b. Press Left/Right to select "Time V". Press **[Enter]** key.
  - c. Press Left/Right key to select "Low". Press **[Enter]** key. Press numeric keys to set low voltage value and press **[Enter]** key.
  - d. Press Left/Right key to select "High". Press **[Enter]** key. Press numeric keys to set high voltage value and press **[Enter]** key.
  - e. Press **[Esc]** key to exit the voltage comparison points setting menu.
  - f. Press Left/Right to select "Time C". Press **[Enter]** key.
  - g. Press Left/Right key to select "Low". Press **[Enter]** key. Press numeric keys to set low current value and press **[Enter]** key.
  - h. Press Left/Right key to select "High". Press **[Enter]** key. Press numeric keys to set high current value and press **[Enter]** key.
  - i. Press **[Esc]** to exit setting.
4. Open the load input.
5. Open power output.
6. Use the following commands to read the voltage rising time, current rising time, voltage positive pulse time and current positive pulse time, when the power supply output is stable.
 

```
SENSe:TIME:VOLTage:UP?
SENSe:TIME:CURRent:UP?
SENSe:VOLTage:POSitive:PULSe?
SENSe:CURRent:POSitive:PULSe?
```
7. Close the power output.
8. Use the following commands to read the voltage falling time, current falling time, voltage negative pulse time and current negative pulse time, when the power supply output is stable.

SENSE:TIME:VOLTage:DOWN?  
 SENSE:TIME:CURRent:DOWN?  
 SENSE:VOLTage:NEGative:PULSe?  
 SENSE:CURRent:NEGative:PULSe?

## 3.15 Configuration Save Function

The electronic load can save some commonly-used parameters in 100-group NVM for convenient and fast usage. The **[Shift]+[4]**(Save) keys can be used for saving parameters. The **[Shift]+[Enter]**(Recall) key is for quick invoking.

The parameters to be saved includes :

- Operation modes for the electronic load (CC/CV/CR/CW);
- The setting parameters under the four constant-status operation modes;
- The setting parameters in the configuration menu.

### Memory Function

When you want to recall the data saved in the memory, you should set memory group in the system menu first. Group 0 means you can recall data saved in 0 to 10 groups. Group 1 means you can recall data saved in 11 to 20 groups. Group2 to Group 9 can be concluded in the same manner.

### Save Operation

If the operator needs to save configured parameter values for direct recall in follow-up operation, refer to the steps below:

E.g., power supply 6V and 3A. The electronic load works under constant current (CC) 1A. Save "CC 1A" in register 39 for recall.

1. Set the parameters ok (CC 1A), and press **[Enter]**.

```
5.89V      0.99A
5.89W      CC= 1.00A
```

2. Press **[Shift]+[4]**(Save) to save the instrument's settings to a register.

```
5.89V      0.99A
5.89W      Save: 1
```

3. Enter number **[3]** and **[9]**, indicates the settings is saved in the 9th register in Group3.

```
5.89V      0.99A
5.89W      Save: 39
```

4. Press **[Enter]** key.



```
5.89V      0.99A
5.89W      CC= 1.00A
```

## Recall Operation

1. Set the memory group number. If the group number has been set to 3 already, you can skip this step.
  - a. Press the composite key **[Shift]+[8]**(System) to enter system menu setting screen.
  - b. Operate Left/Right key and move to the Memory and press **[Enter]** key.
  - c. Set the value of Group to **[3]**, the interface displayed as follows.

```
MEMORY
GROUP=3
```

- d. Press **[Enter]** to confirm the setting.
- e. Press **[Esc]** to return to home screen.

```
5.89V      0.00A
0.00W      CC= 0.00A
```

2. Press **[Shift]+[Enter]**(Recall) to execute the data recalling operation.

```
5.89V      0.00A
0.00W      Recall: 1
```

3. Enter number **[9]**, indicates the data saved in the 9th register in Group3 is recalled.

```
5.89V      0.00A
0.00W      Recall: 9
```

4. Press **[Enter]** to confirm and recall the stored data.

```
5.89V      0.99A
5.89W      CC=1.000A
```

## 3.16 VON Function

When testing some power products with slow voltage rise speed, if the electronic load input is opened before power, the power may latch protection. In this way, the user may set VON value. The electronic load only latches when power voltage is higher than this value.

Press **[Shift] + [9]**(Config) keys to enter configuration menu. Set voltage value in Voltage on under configuration menu to control On/Off status of electronic load. Based on Von value load and unload, the load has two modes: Living and Latch. When Living is selected, it indicates that the work load point is in living status; when Latch is selected, it indicates that the work load point is in latch load status.

**Note**

Please confirm whether it is necessary to set loading voltage, a step that provides convenience for limiting working voltage value. If not necessary, do not set the loading voltage without authorization to prevent unnecessary trouble from failure of loading.

If the instrument cannot load, please firstly check whether the VON function is set. If yes, reset the Von value to minimum value (which may be directly set as 0. If minimum voltage value of instrument is not 0, press 0 for confirmation and the menu will automatically set the value as minimum value).

- When VON LIVING function is started, the load starts load test only when the power voltage rises and is higher than Von Point loading voltage. When the power voltage drops and is lower than Von Point unloading voltage, the load will not unload.

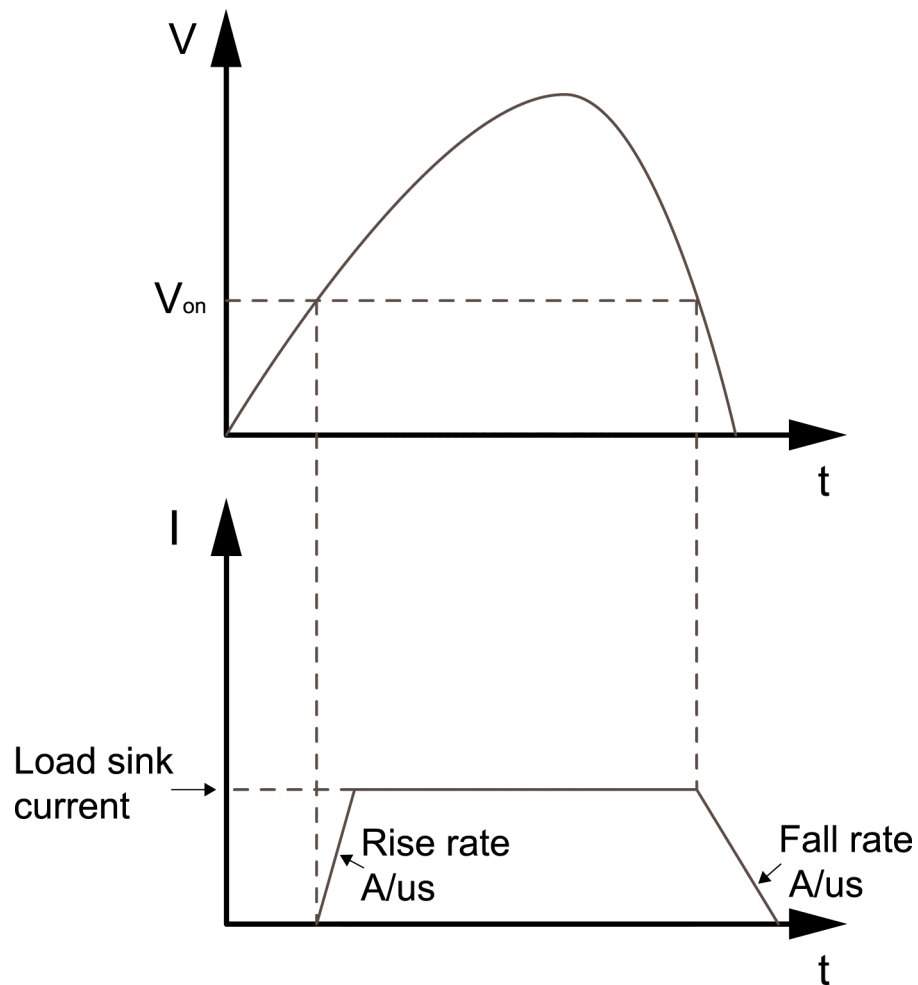

Load working range when VON LIVING is started

- When VON LATCH function is started, the load starts load test only when the power voltage rises and is higher than Von Point loading voltage. When the power voltage drops and is lower than Von Point unloading voltage, the load will not unload.

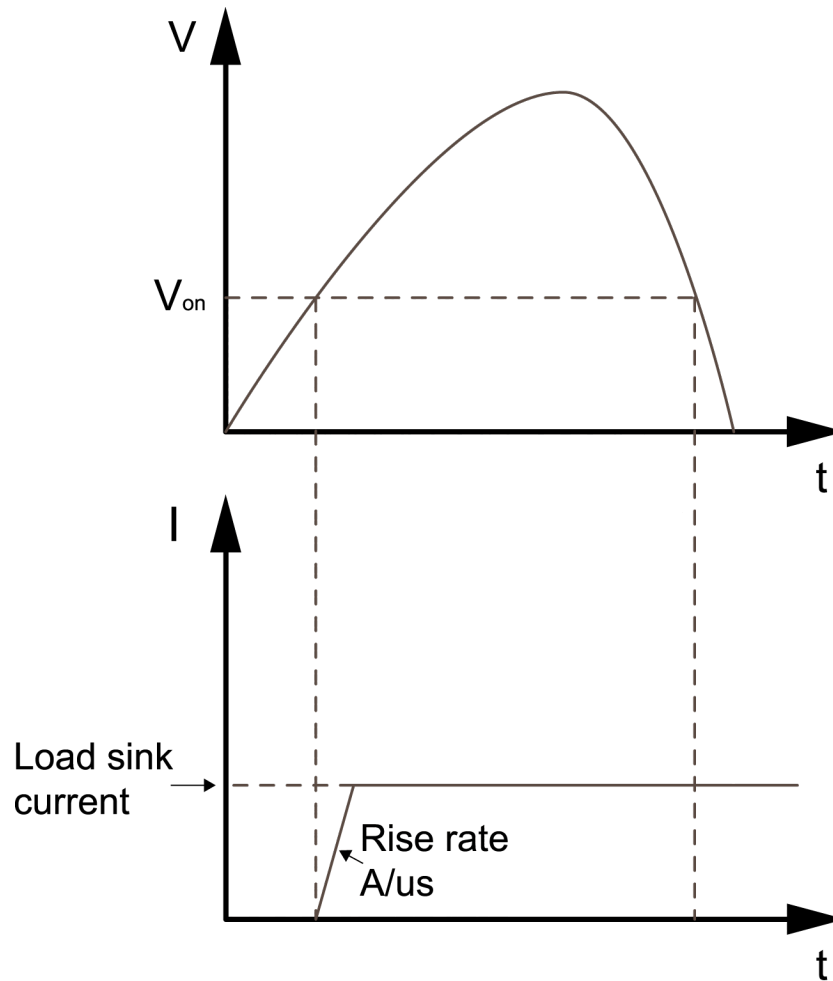

Load working range when VON LATCH is started

## 3.17 Protective Function

The load is provided with following protective functions: overvoltage protection (OVP), overcurrent protection (OCP), overpower protection (OPP), overtemperature protection (OTP) and current oscillation protection(OSC).

### 3.17.1 Overvoltage Protection (OVP)

- **Overvoltage protection:** The load will be immediately Off and the buzzer will sound if the overvoltage circuit is triggered. OV and VF bits of the status register will be set and OVP will be displayed on the screen of the load till resetting.
- **Clear overvoltage protection status:** Inspect whether voltage of object under test is within load rated voltage or set protection voltage range. If not, disconnect the object. Press any key on load front board (or send command PROTECTION:CLEAR), the load front board (OVP) word will get cleared and the load will exit OVP protection status.

### 3.17.2 Overcurrent Protection (OCP)

The electronic load is provided with two kinds of overcurrent protections: hardware overcurrent protection and software overcurrent protection.

- **Hardware overcurrent protection:** maximum load current of the electronic load is limited within about 110% of the existing current range by hardware. When the hardware triggers overcurrent protection, OC bit of the status register will be set; when such protection is removed, the OC bit will be reset. The On/Off status of load will not be changed by the hardware overcurrent protection.
- **Software overcurrent protection:** When software overcurrent protection function is on, if the loading current value exceeds delay of such overcurrent protection set value, the load will automatically be Off and the VFD will display OCP. At the same time, OC and PS bits of the status register will be set and keep till reset.

Set the OCP current value as follows:

1. Press the composite key **[Shift]+[9]**(Config) to enter configuration menu setting screen.
  2. Press Left/Right key to move to the Protect and press **[Enter]**.
  3. Press Left/Right key to move to the I-Limit and press **[Enter]**.
  4. Press Left/Right key to move to the On and press **[Enter]**.
  5. Press numeric keys and set the OCP Point, press **[Enter]** to confirm.
  6. Press numeric keys and set the Delay time, press **[Enter]** to confirm.
  7. Press **[Esc]** to exit setting.
- **Clear overcurrent protection status:**Inspect whether current of object under test is within load rated current or set protection current range. If not, disconnect the object. Press any key on load front board (or send command PROTECTION:CLEAR), the load front board (OCP) word will get cleared and the load will exit OCP protection status.

### 3.17.3 Overpower Protection (OPP)

The electronic load is provided with two kinds of overpower protections: hardware overpower protection and software overpower protection.

- **Hardware overpower protection:**the user can set load hardware overpower protection. Load overpower will be limited to existing power value. The On/Off status of load will not be changed by the hardware overpower protection.

Set the Max-P Point as follows:

1. Press the composite key **[Shift]+[9]**(Config) to enter configuration menu setting screen.
2. Press Left/Right key to move to the Protect and press **[Enter]**.
3. Press Left/Right key to move to the Max-P and press **[Enter]**.
4. Press numeric keys and set the Max-P Point, press **[Enter]** to confirm.

5. Press **[Esc]** to exit setting.
- **Software overpower protection:** If the loading power value exceeds delay of such overpower protection set value, the load will automatically be OFF and the VFD will display OPP. At the same time, OP and PS bits of the status register will be set and keep till reset.  
Set the OPP Power value as follows:
    1. Press the composite key **[Shift]+[9]**(Config) to enter configuration menu setting screen.
    2. Press Left/Right key to move to the Protect and press **[Enter]**.
    3. Press Left/Right key to move to the P-Limit and press **[Enter]**.
    4. Press numeric keys and set the OPP Point, press **[Enter]** to confirm.
    5. Press numeric keys and set the Delay time, press **[Enter]** to confirm.
    6. Press **[Esc]** to exit setting.
  - **Clear overpower protection status:** Inspect whether power of object under test is within load rated power or set protection power range. If not, disconnect the object. Press any key on load front board (or send command to PROTECTION:CLEAR), the load front board (OPP) word will get cleared and the load will exit OPP protection status.

### 3.17.4 Overtemperature Protection (OTP)

- **Overtemperature protection:** When internal power device of load is higher than about 85 °C, the load is under temperature protection. At this time, the load will automatically be OFF and VFD will display OTP. At the same time, OT and PS bits of the status register will be set and keep till reset.
- **Clear overtemperature protection:** When load temperature is decreased to protection point, press any key on load front board (or send command to PROTECTION:CLEAR), the load front board (OTP) word will get cleared and the load will exit OTP protection status.

### 3.17.5 Current Oscillation Protection(OSC)

- **Current oscillation protection:** When the load-on current and the current change frequency exceed a certain limit during the loading process, the current oscillation protection will be triggered. If current oscillation protection is triggered, the load will automatically be Off and the VFD will display “OSC protect!”. At the same time, OSC and PS bits of the status register will be set and keep till reset.
- **Clear current oscillation protection status:** Press any key on load front board (or send command to PROTECTION:CLEAR), the load front board (OSC) word will get cleared and the load will exit OSC protection status.

## 3.18 List Operation

LIST mode provides an accurate, fast and low-cost way to complete any complicated current change mode, which enables synchronization of internal or external signals in multiple quasi-bit load precision tests.

When different trigger sources are selected, the LIST function will form a variety of complex sequences by editing step value, pulse width and slope of each step to meet complicated test requirements. LIST parameters comprise designation of input list file, input step count (2 to 84 steps), step time (0.00002S to 3600S) as well as setting value and slope of each step. The list file can be stored in non-volatile RAM available for a quick output in case of usage. The user can edit 7 groups of list files at maximum.

If the load operation mode is at List operation, the load will start List operation when it receives a trigger signal till completion or receipt of another trigger signal.

Before List operation, be sure to edit List operation files and save them in load non-volatile RAM. Refer to examples below to know how to execute List operation through board. It is assumed that output voltage and current of the tested instrument are 10V and 3A respectively and the load is under CC mode.

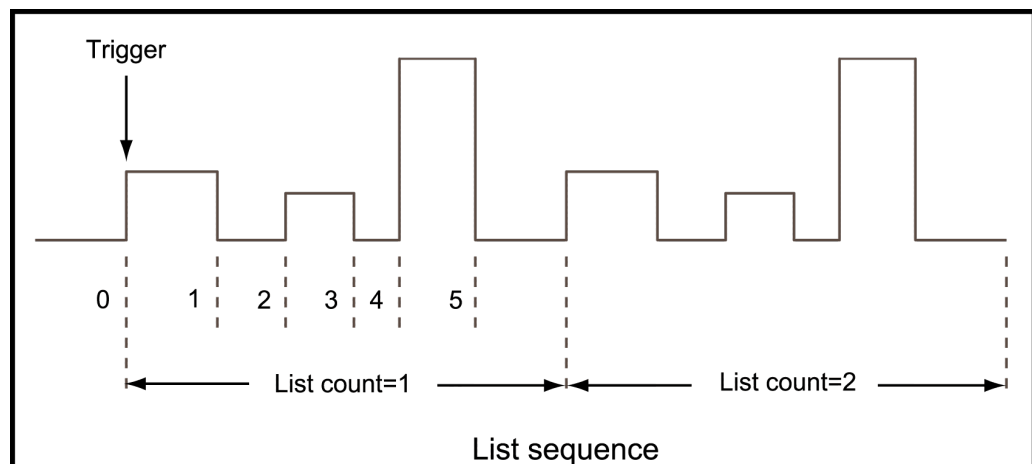

### Operation steps

- Press **[Shift]+[3]**(List) keys. Operate Left/Right key and move to Edit. Press **[Enter]** key.  
LIST  
Off Recall Edit
- Operate Left/Right key and move to the High-Rate and press **[Enter]** key.  
EDIT LIST  
High-Rate Low-Rate
- Set maximum working current value and press **[Enter]** for confirmation.  
EDIT LIST

- Current Range=5.000A
4. Edit number of steps. Press **[2]** key to edit two steps. Press **[Enter]** key.  
 EDIT LIST  
 File Step=2 ( 2-80 )
  5. Edit current value in step 1 and press **[Enter]** key.  
 EDIT LIST  
 Step 01 Level=0.0002A
  6. Edit slope in step 1 and press **[Enter]** key.  
 EDIT LIST  
 Step 01 Rate=0.0010A/mS
  7. Edit time in step 1 and press **[Enter]** key.  
 EDIT LIST  
 Step 01 Width=0.00002S
  8. Edit current value in step 2 and press **[Enter]** key.  
 EDIT LIST  
 Step 02 Level=2.0000A
  9. Edit slope in step 2 and press **[Enter]** key.  
 EDIT LIST  
 Step 02 Rate=1.0000A/mS
  10. Edit time in step 2 and press **[Enter]** key.  
 EDIT LIST  
 Step 02 Width=3600.00000S
  11. Edit repeat count and press **[Enter]** key.  
 EDIT LIST  
 Repeat Count=2 ( 1-65535 )
  12. Save all edited files and press **[Enter]** key.  
 EDIT LIST  
 Save List File=1 ( 1-7 )
  13. Operate Left/Right key and move to on. Press **[Enter]** key (The Trig lamp that indicates VFD screen status is on). Press **[Esc]** key to exit setting.  
 LIST  
 On Recall Edit
  14. Press **[On/Off]** key to open input and press **[Shift]+[.]**(Trigger)key.  
 0.00V            0.00A  
 0.0W            0 LIST1
  15. Press **[CC]/[CV]/[CR]/[CW]** key or any composite function key to exit List test function.

**Note**

If On Recall Edit is displayed under LIST MENU or the external analog control function is switched on, neither List nor Wave file editing is accessible. In this case, change On Recall Edit to Off Recall Edit before operation.

For direct recall of existing List files and triggering of List operation, refer to steps below:

### Operation steps

1. Press **[Shift]+[3]**(List) keys. Operate Left/Right key and move to Recall. Press **[Enter]** key.  
LIST  
Off Recall Edit
2. Select edited files and press **[Enter]** for confirmation.  
RECALL LIST  
Recall List File=1
3. Operate Left/Right key and move to on. Press **[Enter]** key (The Trig lamp that indicates VFD screen status is on). Press **[Esc]** key to exit setting.  
LIST  
On Recall Edit
4. Press **[On/Off]** key to open input and press **[Shift]+[.]**(Trigger) key .  
List operation.

## 3.19 Terminal Function of Rear Panel

Terminals on IT8900A/E rear panel comprise external trigger terminal, external analog control terminal, voltage fault indication terminal, external On/Off control terminal and current monitoring terminal. Terminal schematic (as shown below):

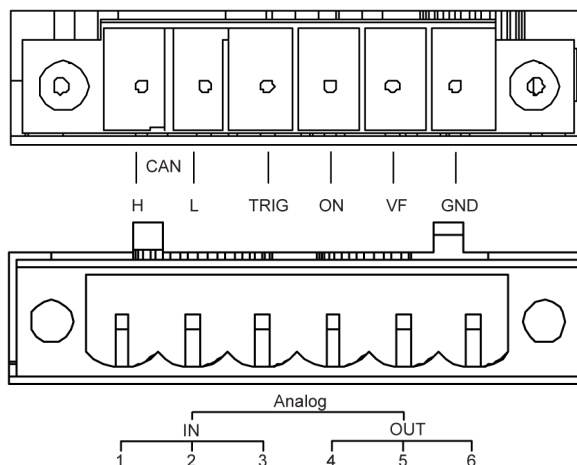

Pin	Pin function
CAN_H , CAN_L	CANH and CANL terminal for CAN communication. (- Incomplete support)
TRIG	Positive input signal terminal for external trigger.



Pin	Pin function
ON	Positive input terminal for external On/Off control.
VF	Positive output terminal for voltage fault indication.
GND	Negative terminal for TRIG, ON and VF.
Analog	Analog input/output signal terminals, used as analog signal for parallel-connection. Analog1: input GND; Analog2: input differential –; Analog3: input differential +; Analog4: output GND; Analog5: output differential –; Analog6: output differential +;
Ext_PRG–, Ext_PRG+ (reuse the Analog input/output signal terminals)	Ext_PRG–: connect terminals Analog1 and Analog2 as a reuse terminal. Ext_PRG+: terminal Analog3.

### 3.19.1 External Trigger Function

When rear board triggering mode is selected, firstly, set the trigger source as External and the triggering signal is input from the rear board TRIG terminal.

When external trigger is selected, the positive and negative TRIG terminals will generate trigger signal and the low pulse is valid. Input corresponding to one trigger can be used for triggering dynamic test, LIST test and auto test.

The user can make the setting in the system menu as the following procedures.

1. Press **[Shift] + [8]**(System) keys to enter system menu.
2. Press Left/Right key to move to the Trigger and press **[Enter]**.
3. Press Left/Right key to move to the External and press **[Enter]**.
4. Press **[Esc]** to exit the menu.

### 3.19.2 External On/Off Control

The load input switches can be controlled by the external TTL electrical level. During external input control, the **[On/Off]** key will become invalid and the load input switches can only be controlled by the external TTL electrical level. The load input will be switched on in case of low level external input; and the load input will be switched off in case of high level external input.

### 3.19.3 Voltage Fault Indication

When load is under overvoltage protection , VF pin voltage fault indication terminal outputs high level.

### 3.19.4 External Analog Function

#### Parallel-Connection Analog Function

Analog input/output signal terminals are on the rear panel, used as analog signal for parallel-connection. Please refer to Parallel Function for detailed description.

#### External Analog Control Function

Loading current of the electronic load can be controlled by Ext\_PRG ( $\pm$ ) analog quantity terminals on rear board. Connect 0 to 10V adjustable voltage at the Ext\_PRGG terminal to analog input from 0 to full range so as to adjust input current of load (10V corresponds to current of load at full range).

The setting method as follows:

1. Press **[Shift]+[9]**(Config) to enter configuration menu(Config Menu).
2. Operate Left/Right key and select Ext-Program. Press **[Enter]** key.
3. Select ON and start external analog control function.
4. Press **[Esc]** to exit the menu and the screen displays Rear.

Connect the terminals as follow.

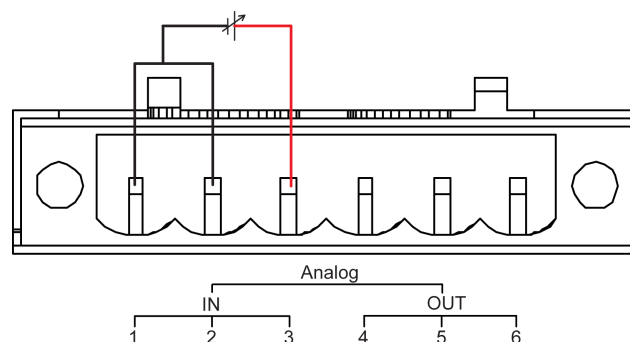

### 3.19.5 Current Monitoring (I Monitor)

The 0 to 10V analog quantity output signal of current monitoring output terminal represents input current to which the terminal belongs from 0 to full range. An external voltmeter or oscilloscope can be connected to display input current change.

## 3.20 Auto Test Function

IT8900A/E series electronic load has a very strong automatic test function. The automatic test function is useful for simulating various tests and allows the user to edit up to 10 groups of testing files. It helps engineers to test out all kinds of data of the tested power supply at different loading status. Automatic test function can edit multiple product tests, such as CC, no-load, short-circuit, CV, so it can finish all test by one time. It makes tests convenient and fast, and ensures high efficiency and testing accuracy.

### Edit test files

1. Press **[Shift]+[6]**(Prog) keys.  
 PROGRAM  
 Run Recall Edit
2. Operate Left/Right key and move to Edit. Press **[Enter]** key to enter editing test files.  
 EDIT PROGRAM  
 Active Sequence=0987654321
3. Press numeric key to select test step and press **[Enter]** key. Active Sequence= 09876543YY (indicating that 1/2 step has been selected).  
 EDIT PROGRAM  
 Active Sequence=09876543YY
4. Select whether pause is necessary for these two steps. If step 2 is to be paused, press **[2]** key. If not, directly press **[Enter]** key.  
 EDIT PROGRAM  
 Pause Sequence=□□□□□□□Y1
5. Select whether short-circuit test is necessary for these two steps. If step 1 is to be tested, press **[1]** key. If not, directly press **[Enter]** key.  
 EDIT PROGRAM  
 Short Sequence=□□□□□□□2Y
6. Set loading time of step 1. If 2S is required, directly press **[2]** key on the board. Press **[Enter]** key.  
 EDIT PROGRAM  
 SEQ 01 On Time=2.0S
7. Set unloading time of step 1. If 2S is required, directly press **[2]** key. Press **[Enter]** key.  
 EDIT PROGRAM  
 SEQ 01 Off Time=2.0S
8. Set test delay time of step 1. If 1S is required, directly press **[1]** key. Press **[Enter]** key. Tpf is delay time before measurement.  
 EDIT PROGRAM  
 SEQ 01 P/F Delay Time=1.0S
9. Set loading time of step 2. If 2S is required, directly press **[2]** key. Press **[Enter]** key.

```

EDIT PROGRAM
SEQ 02 On Time=2.0S
    
```

10. Set unloading time of step 2. If 2S is required, directly press **[2]** key. Press **[Enter]** key.

```

EDIT PROGRAM
SEQ 02 Off Time=2.0S
    
```

11. Set test delay time of step 2. If 1S is required, directly press **[1]** key. Press **[Enter]** key. T<sub>pf</sub> is delay time before measurement.

```

EDIT PROGRAM
SEQ 02 P/F Delay Time=1.0S
    
```

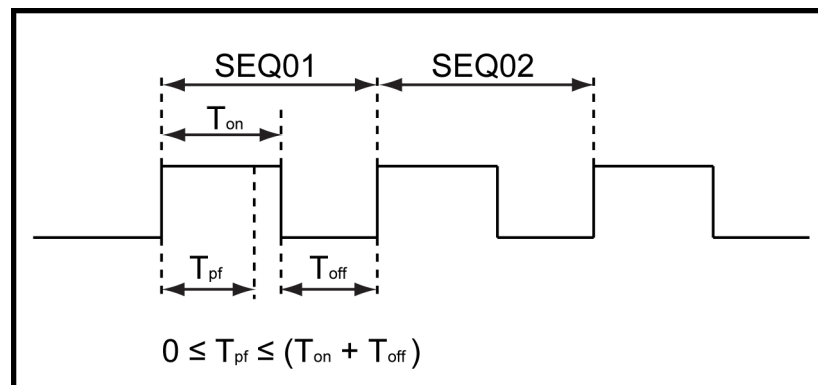

12. Set conditions for stop test. Complete means to stop after all tests are completed and Failure means to stop in case of test error. Press **[Enter]** key.

```

PROGRAM
Complete-Stop   Failure-Stop
    
```

13. Determine whether to link to next group of test file. If it is to link to second group, press **[2]** key. 0 means not to link to other test files. Press **[Enter]** key.

```

PROGRAM
Chain Program File=0 (0-10)
    
```

14. Save the programmed files in EEPROM. A total of 10 groups of files can be saved. If it is to save edited files in group 2, press **[2]** key. Press **[Enter]** key.

```

PROGRAM
Save Program File=2 (1-10)
    
```

15. Press **[Esc]** key to exit editing menu.

### Note

In the following editing procedures, "Y" indicates selected status. To cancel selected status, press numeric key of corresponding step again.  
The above steps only set entire framework of auto tests. Additional setting is required for specific parameters in each step. This design will facilitate modification of parameters in a single step.

## Edit Auto Test Step Parameter

After setting of entire structure of auto test, settings at each step should be independently saved. Take CC and CV mode as an example to describe how to

edit auto test step parameters as below. The step editing methods of CR and CW modes are similar.

It is assumed that step 1 edits CC mode as follows: current: 2A, maximum voltage value: 10V, and minimum voltage value: 2V.

1. Press the **[CC]** key to set the current value as 2A. Press the **[Shift] + [CV]** (-Setup) keys to enter the parameter setting page.

```
Constant Current
Range=240.00A
```

2. Set the maximum working current value, and enter the **[Enter]** key.

```
Constant Current
Range =200.00A
```

3. Set the maximum voltage value, and enter the **[Enter]** key.

```
Constant Current
High=10.0V
```

4. Set the minimum voltage value, and enter the **[Enter]** key.

```
Constant Current
Low=2.0V
```

5. Select the high or low rate, and enter the **[Enter]** key.

```
Constant Current
High-Rate Low-Rate
```

6. Set the current rising slope, and enter the **[Enter]** key.

```
Constant Current
Rise up=2.0000A/mS
```

7. Set the current falling slope, and enter the **[Enter]** key.

```
Constant Current
Fall down=2.0000A/mS
```

After the parameter settings are complete, the page is shown as follows.

```
0.00V      0.00A
0.0W      CC=2.00A
```

8. Press **[Shift]+[4]**(Save) keys for saving. Press **[11]** to save as the first step of the Program 2.

```
0.00V      0.00A
0.00W      Save : 11
```

It is assumed that step 2 edits CV mode as follows: voltage: 3V, maximum current value: 5A, and minimum current value: 0A

1. Press the **[CV]** key to set the voltage value as 3V. Press the **[Shift]+[CV]** (-Setup) keys to enter the parameter setting page.

```
Constant Voltage
Range=1200.0V
```

2. Set the maximum working voltage value, and enter the **[Enter]** key.

```
Constant Voltage  
Range=1000.0V
```

3. Set the maximum current value, and enter the **[Enter]** key.

```
Constant Voltage  
High=5.00A
```

4. Set the minimum current value, and enter the **[Enter]** key.

```
Constant Voltage  
Low=0.00A
```

5. Set limited current value under CV mode and press **[Enter]** key.

```
Constant Voltage  
I-Limit=240.00A
```

6. Set high and low rate and press **[Enter]** key.

```
Constant Voltage  
High-Rate Low-Rate
```

After the parameter settings are complete, the page is shown as follows.

```
0.0V      0.00A  
0.0W      CV=3.0V
```

7. Press **[Shift]+[4]**(Save) keys for saving. Press **[12]** to save as the second step of the Program 2.

```
0.00V      0.00A  
0.00W      Save : 12
```

**Note**

Settings at each step should be independently saved. Saving positions of step parameters are related to save group and step number of auto test files. If the auto test file is saved in group 1, the saving position of step parameter is consistent with the step number; if the auto test file is saved in group 2, the saving position is 1+ step number, for example, steps 1, 2 and 3 are saved in 11, 12 and 13 respectively; if the auto test file is saved in group 3, the saving position is 2+ step number, for example, steps 1, 2 and 3 are saved in 21, 22 and 23 respectively, and so on. Refer to the following table for saving position Correspondence Table of Auto test files and step parameter saving.

Program 1 Sequence	1	2	3	4	5	6	7	8	9	10
Save Group	1	2	3	4	5	6	7	8	9	10
Program 2 Sequence	1	2	3	4	5	6	7	8	9	10
Save Group	11	12	13	14	15	16	17	18	19	20
:	:	:	:	:	:	:	:	:	:	:
:	:	:	:	:	:	:	:	:	:	:
Program 10 Sequence	1	2	3	4	5	6	7	8	9	10
Save Group	91	92	93	94	95	96	97	98	99	100

### Recall test file for running

To recall edited test files from EEPROM quickly after re-energizing instrument, refer to the method below.

1. Press **[Shift] + [6]**(Prog) keys.

```
PROGRAM
Run Recall Edit
```

2. Operate Left/Right key, select Recall and press **[Enter]** key.

```
RECALL PROGRAM
Recall Program File=2
```

3. Operate Left/Right key, select Run and press **[Enter]** key.

```
PROGRAM
Run Recall Edit
```

4. Display auto test file 2.

```
0.00V      0.00A
PRG02 STOP
```

5. Press **[Shift]+[.]** (Trigger) key. Operate auto test file 2.

```
0.00V      0.00A
PRG02-01 On Pass
```

6. Press **[Shift]+[0]**(Pause) key to pause auto test. Press Down key for next step.

## 3.21 Parallel Function

The maximum power of IT8900A/E series electronic loads is 60 KW. The user can connect electronic loads in parallel to provide a greater current and power capability. The electronic Load is capable of connecting up to nine units in parallel, reaching at most 384 KW. Take 4U models as an example, the following figure shows three units connected in parallel. The System Bus is used as connection between master and slaves; the Analog is used as analog signal connection for parallel.

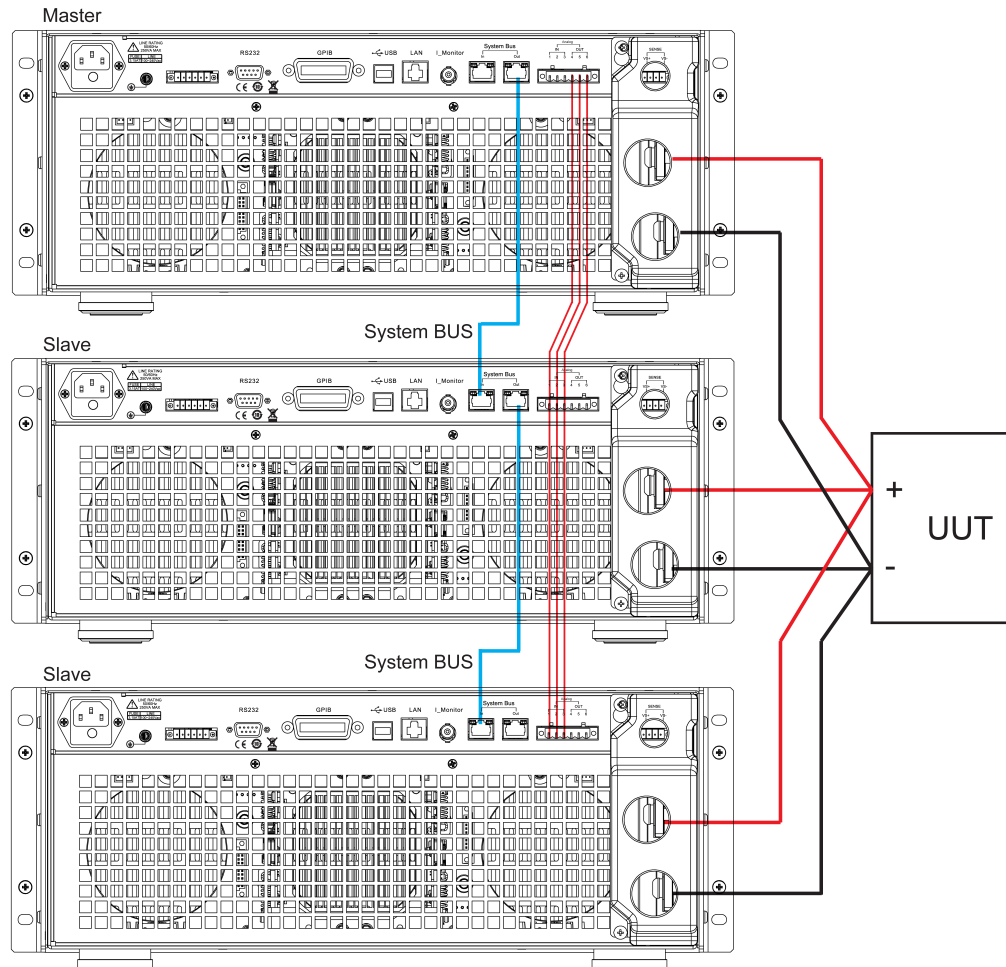

### CAUTION

- Before connecting the system bus, the parallel mode must be single.
- When connecting the system bus, please note the built-in terminating resistor at the rear panel. If the resistor is removed, the instrument may not work properly. The user can install the terminating resistor on the Input end of the first system bus and the Output end of the last system bus.



The operation steps of parallel function are described below taking 3 instruments (1 Master and 2 Slave) in parallel as an example.

1. Connect the instruments according to the above diagram.
  - a. Use standard network cables to connect System Bus terminals.
  - b. Use three-prong shield wires to connect Analog terminals.
  - c. Connect DUT. Refer to [1.5 Connecting the DUT](#) for detailed wiring method. To ensure the safety of the test, use a separate red and black test line to connect the input terminals of each instrument to the terminals of the object to be tested.
2. After connection, configure one electric load as a master unit and other electronic loads as slave units.
  - a. Press the composite key **[Shift]+[8]**(System) to enter the System Menu.
  - b. Press the Right key to select "Parallel" and press **[Enter]** for parallel setting.
    - Single: Single mode.
    - Slave: Slave mode.
    - Master: Master mode. If Master mode is selected, you need to set the number of Slaves for the Master.
    - Total: total number of instruments in parallel. For example, Total = 3.
3. After making the master-slave setting, to ensure normal operation, you need to restart the electronic loads.

**To change Parallel Mode to Single Mode, follow the steps below:**

1. Power off 3 instruments respectively.
2. Remove System Bus, Analog cables and parallel wires among three electronic loads.
3. Power on 3 instruments respectively.
4. Switch three instruments into single mode respectively.
  - a. Press the composite key **[Shift]+[8]**(System) to enter the System Menu.
  - b. Press the Left/Right key to select "Parallel" and press **[Enter]** key.
  - c. Press the Left/Right key to select "Single" and press **[Enter]** key.
5. After setting, to ensure normal operation, you need to restart the electronic loads.

# 4 Technical Specification

This chapter will introduce the main technical parameters of this load , such as rated voltage/current/power and so on. Besides, we will introduce the working environment and storage temperature.

- ◆ Main specifications
- ◆ Additional features

## 4.1 Main specifications

### 4.1.1 IT8902A-150-200

Model		IT8902A-150-200	
Rated value ( 0~40 °C)	Input voltage	0~150V	
	Input current	0~20A	0~200A
	Input power	2KW	
	Min. operating voltage	0.18V/20A	1.8V/200A
Constant voltage mode	Range	0.1~18V	0.1~150V
	Resolution	1mV	10mV
	Accuracy	±(0.05%+0.05%FS)	±(0.05%+0.05%FS)
Constant current mode	Range	0~20A	0~200A
	Resolution	1mA	10mA
	Accuracy	±(0.05%+0.1%FS)	±(0.05%+0.1%FS)
Constant resistance mode*1	Range	0.01Ω~10Ω	10Ω~7.5KΩ
	Resolution	16bit	
	Accuracy	0.01%+0.08S *2	0.01%+0.0008S
Constant power Mode*3	Range	2KW	
	Resolution	0.1W	
	Accuracy	0.2%+0.2%FS	
Dynamic Mode			
Dynamic Mode*4	CC Mode		
	T1 & T2	20uS~3600S /Res:1 us/10ms/100ms	

Model		IT8902A-150-200	
	Accuracy	5uS±100ppm	
	Ascending/descending slope	0.001~0.4A/uS	0.01~4A/uS
	Min. rise time	≈12uS	≈12uS
Measuring range			
Read-back voltage	Range	0~18V	0~150V
	Resolution	1mV	10mV
	Accuracy	±(0.025%+0.025%FS)	±(0.025%+0.025%FS)
Read-back current	Range	0~20A	0~200A
	Resolution	1mA	10mA
	Accuracy	±(0.05%+0.1%FS)	±(0.05%+0.1%FS)
Read-back power*2	Range	2KW	
	Resolution	0.1W	
	Accuracy	±(0.2%+0.2%FS)	
Protection range			
Overpower protection	≈2.02KW		
Overcurrent protection	≈21A	≈210A	
Overvoltage protection	≈157V		
Overtemperature protection	≈85°C		
Specification			
Short circuit	Current (CC)	≈21A	≈210A
	Voltage (CV)	≈0V	≈0V
	Resistance (CR)	≈9mΩ	
Input terminal impedance	≈800KΩ		
Height	4U		
Weight	28 Kg		
AC Input	Voltage	100~240Vac	
	Frequency	50/60Hz	
	Power	150VA max	

\*1.The voltage/current input is no less than 10%FS (FS indicates the full scope).

\*2.The scope of read-back resistance is  $(1/(1/R+(1/R)*0.01\%+0.08), 1/(1/R-(1/R)*0.01\%-0.08))$ .

\*3.The voltage/current input is no less than 10%FS.

\*4.The load current value is no less than 4% of FS\_CCH.

## 4.1.2 IT8902A-600-140

Model		IT8902A-600-140	
Rated value ( 0~40 °C)	Input voltage	0~600V	
	Input current	0~14A	0~140A
	Input power	2KW	
	Min. operating voltage	0.42V/14A	4.2V/140A
Constant voltage mode	Range	0.1~60V	0.1~600V
	Resolution	1mV	10mV
	Accuracy	$\pm(0.05\%+0.05\%FS)$	$\pm(0.05\%+0.05\%FS)$
Constant current mode	Range	0~14A	0~140A
	Resolution	1mA	10mA
	Accuracy	$\pm(0.05\%+0.1\%FS)$	$\pm(0.05\%+0.1\%FS)$
Constant resistance mode*1	Range	0.03Ω~10Ω	10Ω~7.5KΩ
	Resolution	16bit	
	Accuracy	0.01%+0.08S *2	0.01%+0.0008S
Constant power Mode*3	Range	2KW	
	Resolution	0.1W	
	Accuracy	0.2%+0.2%FS	
Dynamic Mode			
Dynamic Mode*4	CC Mode		
	T1 & T2	20uS~3600S /Res:1 us/10ms/100ms	
	Accuracy	5uS±100ppm	
	Ascending/de-descending slope	0.001~0.2A/uS	0.01~2A/uS
	Min. rise time	≈20uS	≈20uS
Measuring range			
Read-back voltage	Range	0~60V	0~600V

Model		IT8902A-600-140	
	Resolution	1mV	10mV
	Accuracy	$\pm(0.025\%+0.025\%FS)$	$\pm(0.025\%+0.025\%FS)$
Read-back current	Range	0~14A	0~140A
	Resolution	1mA	10mA
	Accuracy	$\pm(0.05\%+0.1\%FS)$	$\pm(0.05\%+0.1\%FS)$
Read-back power*2	Range	2KW	
	Resolution	0.1W	
	Accuracy	$\pm(0.2\%+0.2\%FS)$	
Protection range			
Overpower protection	$\approx 2.02KW$		
Overcurrent protection	$\approx 14.7A$	$\approx 147A$	
Overvoltage protection	$\approx 630V$		
Overtemperature protection	$\approx 85^{\circ}C$		
Specification			
Short circuit	Current (CC)	$\approx 14.7A$	$\approx 147A$
	Voltage (CV)	$\approx 0V$	$\approx 0V$
	Resistance (CR)	$\approx 30m\Omega$	
Input terminal impedance	$\approx 1M\Omega$		
Height	4U		
Weight	28Kg		
AC Input	Voltage	100~240Vac	
	Frequency	50/60Hz	
	Power	150VA max	

\*1.The voltage/current input is no less than 10%FS (FS indicates the full scope).

\*2.The scope of read-back resistance is  $(1/(1/R+(1/R)*0.01\%+0.08), 1/(1/R-(1/R)*0.01\%-0.08))$ .

\*3.The voltage/current input is no less than 10%FS.

\*4.The load current value is no less than 4% of FS\_CCH.

### 4.1.3 IT8902A-1200-80

Model		IT8902A-1200-80	
Rated value ( 0~40 °C)	Input voltage	0~1200V	
	Input current	0~8A	0~80A
	Input power	2KW	
	Min. operating voltage	1.2V/8A	12V/80A
Constant voltage mode	Range	0.1~120V	0.1~1200V
	Resolution	10mV	100mV
	Accuracy	±(0.05%+0.05%FS)	±(0.05%+0.05%FS)
Constant current mode	Range	0~8A	0~80A
	Resolution	0.1mA	1mA
	Accuracy	±(0.05%+0.1%FS)	±(0.05%+0.1%FS)
Constant resistance mode*1	Range	0.2Ω~10Ω	10Ω~7.5KΩ
	Resolution	16bit	
	Accuracy	0.01%+0.08S *2	0.01%+0.0008S
Constant power Mode*3	Range	2KW	
	Resolution	0.1W	
	Accuracy	0.2%+0.2%FS	
Dynamic Mode			
Dynamic Mode*4	CC Mode		
	T1 & T2	20uS~3600S /Res:1 us/10ms/100ms	
	Accuracy	5uS±100ppm	
	Ascending/descending slope	0.0001~0.1A/uS	0.001~1 A/uS
	Min. rise time	≅30uS	≅30uS
Measuring range			
Read-back voltage	Range	0~120V	0~1200V
	Resolution	10mV	100mV
	Accuracy	±(0.025%+0.025%FS)	±(0.025%+0.025%FS)
Read-back current	Range	0~8A	0~80A
	Resolution	0.1mA	1mA
	Accuracy	±(0.05%+0.1%FS)	±(0.05%+0.1%FS)
Read-back power*2	Range	2KW	

Model		IT8902A-1200-80	
	Resolution	0.1W	
	Accuracy	±(0.2%+0.2%FS)	
Protection range			
Overpower protection	≒2.02KW		
Overcurrent protection	≒8.4A	≒84A	
Overvoltage protection	≒1250V		
Overtemperature protection	≒85°C		
Specification			
Short circuit	Current (CC)	≒8.4A	≒84A
	Voltage (CV)	0V	0V
	Resistance (CR)	≒150mΩ	≒150mΩ
Input terminal impedance	≒1.8MΩ		
Height	4U		
Weight	28Kg		
AC Input	Voltage	100~240Vac	
	Frequency	50/60Hz	
	Power	150VA max	

\*1.The voltage/current input is no less than 10%FS (FS indicates the full scope).

\*2.The scope of read-back resistance is  $(1/(1/R+(1/R)*0.01\%+0.08), 1/(1/R-(1/R)*0.01\%-0.08))$ .

\*3.The voltage/current input is no less than 10%FS.

\*4.The load current value is no less than 4% of FS\_CCH.

#### 4.1.4 IT8902E-150-200

Model		IT8902E-150-200	
Rated value ( 0~40 °C)	Input voltage	0~150V	
	Input current	0~20A	0~200A
	Input power	2KW	

Model		IT8902E-150-200	
	Min. operating voltage	0.18V/20A	1.8V/200A
Constant voltage mode	Range	0.1~18V	0.1~150V
	Resolution	1mV	10mV
	Accuracy	$\pm(0.05\%+0.05\%FS)$	$\pm(0.05\%+0.05\%FS)$
Constant current mode	Range	0~20A	0~200A
	Resolution	1mA	10mA
	Accuracy	$\pm(0.1\%+0.1\%FS)$	$\pm(0.1\%+0.1\%FS)$
Constant resistance mode*1	Range	0.01 $\Omega$ ~10 $\Omega$	10 $\Omega$ ~7.5K $\Omega$
	Resolution	16bit	
	Accuracy	0.01%+0.08S *2	0.01%+0.0008S
Constant power Mode*3	Range	2KW	
	Resolution	0.1W	
	Accuracy	0.2%+0.3%FS	
Dynamic Mode			
Dynamic Mode*4	CC Mode		
	T1 & T2	20 $\mu$ S~3600S /Res:1 $\mu$ s/10ms/100ms	
	Accuracy	5 $\mu$ S $\pm$ 100ppm	
	Ascending/descending slope	0.001~0.24A/ $\mu$ S	0.01~2.4A/ $\mu$ S
Measuring range			
Read-back voltage	Range	0~18V	0~150V
	Resolution	1mV	10mV
	Accuracy	$\pm(0.025\%+0.025\%FS)$	$\pm(0.025\%+0.025\%FS)$
Read-back current	Range	0~20A	0~200A
	Resolution	1mA	10mA
	Accuracy	$\pm(0.1\%+0.1\%FS)$	$\pm(0.1\%+0.1\%FS)$
Read-back power*2	Range	2KW	
	Resolution	0.1W	
	Accuracy	$\pm(0.2\%+0.3\%FS)$	
Protection range			
Overpower protection	$\approx$ 2.02KW		



Model		IT8902E-150-200	
Overcurrent protection		≈21A	≈210A
Overvoltage protection		≈157V	
Overtemperature protection		≈85°C	
Specification			
Short circuit	Current (CC)	≈21A	≈210A
	Voltage (CV)	≈0V	≈0V
	Resistance (CR)	≈9mΩ	
Input terminal impedance		≈800KΩ	
Height		4U	
Weight		28 Kg	
AC Input	Voltage	100~240Vac	
	Frequency	50/60Hz	
	Power	150VA max	

\*1.The voltage/current input is no less than 10%FS (FS indicates the full scope).

\*2.The scope of read-back resistance is  $(1/(1/R+(1/R)*0.01\%+0.08), 1/(1/R-(1/R)*0.01\%-0.08))$ .

\*3.The voltage/current input is no less than 10%FS.

\*4.The load current value is no less than 4% of FS\_CCH.

### 4.1.5 IT8902E-600-140

Model		IT8902E-600-140	
Rated value ( 0~40 °C)	Input voltage	0~600V	
	Input current	0~14A	0~140A
	Input power	2KW	
	Min. operating voltage	0.42V/14A	4.2V/140A
Constant voltage mode	Range	0.1~60V	0.1~600V
	Resolution	1mV	10mV
	Accuracy	±(0.05%+0.05%FS)	±(0.05%+0.05%FS)

Model		IT8902E-600-140	
Constant current mode	Range	0~14A	0~140A
	Resolution	1mA	10mA
	Accuracy	$\pm(0.1\%+0.1\%FS)$	$\pm(0.1\%+0.1\%FS)$
Constant resistance mode*1	Range	0.03 $\Omega$ ~10 $\Omega$	10 $\Omega$ ~7.5K $\Omega$
	Resolution	16bit	
	Accuracy	0.01%+0.08S *2	0.01%+0.0008S
Constant power Mode*3	Range	2KW	
	Resolution	0.1W	
	Accuracy	0.2%+0.3%FS	
Dynamic Mode			
Dynamic Mode*4	CC Mode		
	T1 & T2	20 $\mu$ S~3600S /Res:1 $\mu$ s/10ms/100ms	
	Accuracy	5 $\mu$ S $\pm$ 100ppm	
	Ascending/de-descending slope	0.001~0.16A/ $\mu$ S	0.01~1.6A/ $\mu$ S
Measuring range			
Read-back voltage	Range	0~60V	0~600V
	Resolution	1mV	10mV
	Accuracy	$\pm(0.025\%+0.025\%FS)$	$\pm(0.025\%+0.025\%FS)$
Read-back current	Range	0~14A	0~140A
	Resolution	1mA	10mA
	Accuracy	$\pm(0.1\%+0.1\%FS)$	$\pm(0.1\%+0.1\%FS)$
Read-back power*2	Range	2KW	
	Resolution	0.1W	
	Accuracy	$\pm(0.2\%+0.3\%FS)$	
Protection range			
Overpower protection	$\approx$ 2.02KW		
Overcurrent protection	$\approx$ 14.7A	$\approx$ 147A	
Overvoltage protection	$\approx$ 630V		
Overtemperature protection	$\approx$ 85 $^{\circ}$ C		

Model		IT8902E-600-140	
Specification			
Short circuit	Current (CC)	$\approx 14.7A$	$\approx 147A$
	Voltage (CV)	$\approx 0V$	$\approx 0V$
	Resistance (CR)	$\approx 30m\Omega$	
Input terminal impedance	$\approx 1M\Omega$		
Height	4U		
Weight	28Kg		
AC Input	Voltage	100~240Vac	
	Frequency	50/60Hz	
	Power	150VA max	

\*1.The voltage/current input is no less than 10%FS (FS indicates the full scope).

\*2.The scope of read-back resistance is  $(1/(1/R+(1/R)*0.01\%+0.08), 1/(1/R-(1/R)*0.01\%-0.08))$ .

\*3.The voltage/current input is no less than 10%FS.

\*4.The load current value is no less than 4% of FS\_CCH.

## 4.1.6 IT8902E-1200-80

Model		IT8902E-1200-80	
Rated value (0 ~ 40 °C)	Input voltage	0~1200V	
	Input current	0~8A	0~80A
	Input power	2KW	
	Min. operating voltage	1.2V/8A	12V/80A
Constant voltage mode	Range	0.1~120V	0.1~1200V
	Resolution	10mV	100mV
	Accuracy	$\pm(0.05\%+0.05\%FS)$	$\pm(0.05\%+0.05\%FS)$
Constant current mode	Range	0~8A	0~80A
	Resolution	0.1mA	1mA
	Accuracy	$\pm(0.1\%+0.1\%FS)$	$\pm(0.1\%+0.1\%FS)$
Constant resistance mode*1	Range	0.2 $\Omega$ ~10 $\Omega$	10 $\Omega$ ~7.5K $\Omega$

Model		IT8902E-1200-80	
	Resolution	16bit	
	Accuracy	0.01%+0.08S *2	0.01%+0.0008S
Constant power Mode*3	Range	2KW	
	Resolution	0.1W	
	Accuracy	0.2%+0.3%FS	
Dynamic Mode			
Dynamic Mode*4	CC Mode		
	T1 & T2	20uS~3600S /Res:1 us/10ms/100ms	
	Accuracy	5uS±100ppm	
	Ascending/descending slope	0.0001~0.08A/uS	0.001~0.8A/uS
Measuring range			
Read-back voltage	Range	0~120V	0~1200V
	Resolution	10mV	100mV
	Accuracy	±(0.025%+0.025%FS)	±(0.025%+0.025%FS)
Read-back current	Range	0~8A	0~80A
	Resolution	0.1mA	1mA
	Accuracy	±(0.1%+0.1%FS)	±(0.1%+0.1%FS)
Read-back power*2	Range	2KW	
	Resolution	0.1W	
	Accuracy	±(0.2%+0.3%FS)	
Protection range			
Overpower protection	≈2.02KW		
Overcurrent protection	≈8.4A	≈84A	
Overvoltage protection	≈1250V		
Overtemperature protection	≈85°C		
Specification			
Short circuit	Current (CC)	≈8.4A	≈84A
	Voltage (CV)	≈0V	≈0V
	Resistance (CR)	≈150mΩ	≈150mΩ

Model		IT8902E-1200-80	
Input terminal impedance	≈1.8MΩ		
Height	4U		
Weight	28 Kg		
AC Input	Voltage	100~240Vac	
	Frequency	50/60Hz	
	Power	150VA max	

\*1.The voltage/current input is no less than 10%FS (FS indicates the full scope).

\*2.The scope of read-back resistance is  $(1/(1/R+(1/R)*0.01\%+0.08), 1/(1/R-(1/R)*0.01\%-0.08))$ .

\*3.The voltage/current input is no less than 10% FS.

\*4.The load current value is no less than 4% of FS\_CCH.

### 4.1.7 IT8904A-150-400

Model		IT8904A-150-400	
Rated value ( 0~40 °C)	Input voltage	0~150V	
	Input current	0~40A	0~400A
	Input power	4KW	
	Min. operating voltage	0.18V/40A	1.8V/400A
Constant voltage mode	Range	0.1~18V	0.1~150V
	Resolution	1mV	10mV
	Accuracy	±(0.05%+0.05%FS)	±(0.05%+0.05%FS)
Constant current mode	Range	0~40A	0~400A
	Resolution	1mA	10mA
	Accuracy	±(0.05%+0.1%FS)	±(0.05%+0.1%FS)
Constant resistance mode*1	Range	0.005Ω~10Ω	10Ω~7.5KΩ
	Resolution	16bit	
	Accuracy	0.01%+0.08S *2	0.01%+0.0008S
Constant power Mode*3	Range	4KW	
	Resolution	0.1W	
	Accuracy	0.2%+0.2%FS	

Model		IT8904A-150-400	
Dynamic Mode			
Dynamic Mode*4	CC Mode		
	T1 & T2	20uS~3600S /Res:1 us/10ms/100ms	
	Accuracy	5uS±100ppm	
	Ascending/descending slope	0.001~0.8A/uS	0.01~8A/uS
	Min. rise time	≈12uS	≈12uS
Measuring range			
Read-back voltage	Range	0~18V	0~150V
	Resolution	1mV	10mV
	Accuracy	±(0.025%+0.025%FS)	±(0.025%+0.025%FS)
Read-back current	Range	0~40A	0~400A
	Resolution	1mA	10mA
	Accuracy	±(0.05%+0.1%FS)	±(0.05%+0.1%FS)
Read-back power*2	Range	4KW	
	Resolution	0.1W	
	Accuracy	±(0.2%+0.2%FS)	
Protection range			
Overpower protection	≈4.04KW		
Overcurrent protection	≈42A	≈420A	
Overvoltage protection	≈157V		
Overtemperature protection	≈85°C		
Specification			
Short circuit	Current (CC)	≈42A	≈420A
	Voltage (CV)	≈0V	≈0V
	Resistance (CR)	≈4.5mΩ	
Input terminal impedance	≈800KΩ		
Height	4U		
Weight	34 Kg		
AC Input	Voltage	100~240Vac	

Model		IT8904A-150-400
	Frequency	50/60Hz
	Power	200VA max

\*1.The voltage/current input is no less than 10%FS (FS indicates the full scope).

\*2.The scope of read-back resistance is  $(1/(1/R+(1/R)*0.01\%+0.08), 1/(1/R-(1/R)*0.01\%-0.08))$ .

\*3.The voltage/current input is no less than 10%FS.

\*4.The load current value is no less than 4% of FS\_CCH.

### 4.1.8 IT8904A-600-280

Model		IT8904A-600-280	
Rated value ( 0~40 °C)	Input voltage	0~600V	
	Input current	0~28A	0~280A
	Input power	4KW	
	Min. operating voltage	0.42V/28A	4.2V/280A
Constant voltage mode	Range	0.1~60V	0.1~600V
	Resolution	1mV	10mV
	Accuracy	$\pm(0.05\%+0.05\%FS)$	$\pm(0.05\%+0.05\%FS)$
Constant current mode	Range	0~28A	0~280A
	Resolution	1mA	10mA
	Accuracy	$\pm(0.05\%+0.1\%FS)$	$\pm(0.05\%+0.1\%FS)$
Constant resistance mode*1	Range	0.02Ω~10Ω	10Ω~7.5KΩ
	Resolution	16bit	
	Accuracy	0.01%+0.08S *2	0.01%+0.0008S
Constant power Mode*3	Range	4KW	
	Resolution	0.1W	
	Accuracy	0.2%+0.2%FS	
Dynamic Mode			
Dynamic Mode*4	CC Mode		
	T1 & T2	20uS~3600S /Res:1 us/10ms/100ms	
	Accuracy	5uS±100ppm	

Model		IT8904A-600-280	
	Ascending/de- scending slope	0.001~0.4A/uS	0.01~4A/uS
	Min. rise time	≈20uS	≈20uS
Measuring range			
Read-back voltage	Range	0~60V	0~600V
	Resolution	1mV	10mV
	Accuracy	±(0.025%+0.025%FS)	±(0.025%+0.025%FS)
Read-back current	Range	0~28A	0~280A
	Resolution	1mA	10mA
	Accuracy	±(0.05%+0.1%FS)	±(0.05%+0.1%FS)
Read-back power*2	Range	4KW	
	Resolution	0.1W	
	Accuracy	±(0.2%+0.2%FS)	
Protection range			
Overpower protection	≈4.04KW		
Overcurrent protection	≈29.4A	≈294A	
Overvoltage protection	≈630V		
Overtemperature protection	≈85°C		
Specification			
Short circuit	Current (CC)	≈29.4A	≈294A
	Voltage (CV)	≈0V	≈0V
	Resistance (CR)	≈15mΩ	
Input terminal impedance	≈1MΩ		
Height	4U		
Weight	34 Kg		
AC Input	Voltage	100~240Vac	
	Frequency	50/60Hz	
	Power	200VA max	

\*1.The voltage/current input is no less than 10%FS (FS indicates the full scope).



\*2.The scope of read-back resistance is  $(1/(1/R+(1/R)*0.01\%+0.08), 1/(1/R-(1/R)*0.01\%-0.08))$ .

\*3.The voltage/current input is no less than 10%FS.

\*4.The load current value is no less than 4% of FS\_CCH.

## 4.1.9 IT8904A-1200-160

Model		IT8904A-1200-160	
Rated value ( 0~40 °C)	Input voltage	0~1200V	
	Input current	0~16A	0~160A
	Input power	4KW	
	Min. operating voltage	1.2V/16A	12V/160A
Constant voltage mode	Range	0.1~120V	0.1~1200V
	Resolution	10mV	100mV
	Accuracy	$\pm(0.05\%+0.05\%FS)$	$\pm(0.05\%+0.05\%FS)$
Constant current mode	Range	0~16A	0~160A
	Resolution	1mA	10mA
	Accuracy	$\pm(0.05\%+0.1\%FS)$	$\pm(0.05\%+0.1\%FS)$
Constant resistance mode*1	Range	0.1Ω~10Ω	10Ω~7.5KΩ
	Resolution	16bit	
	Accuracy	0.01%+0.08S *2	0.01%+0.0008S
Constant power Mode*3	Range	4KW	
	Resolution	0.1W	
	Accuracy	0.2%+0.2%FS	
Dynamic Mode			
Dynamic Mode*4	CC Mode		
	T1 & T2	20uS~3600S /Res:1 us/10ms/100ms	
	Accuracy	5uS±100ppm	
	Ascending/descending slope	0.001~0.2A/uS	0.01~2 A/uS
	Min. rise time	≈30uS	≈30uS
Measuring range			
Read-back voltage	Range	0~120V	0~1200V
	Resolution	10mV	100mV

Model		IT8904A-1200-160	
	Accuracy	$\pm(0.025\%+0.025\%FS)$	$\pm(0.025\%+0.025\%FS)$
Read-back current	Range	0~16A	0~160A
	Resolution	1mA	10mA
	Accuracy	$\pm(0.05\%+0.1\%FS)$	$\pm(0.05\%+0.1\%FS)$
Read-back power*2	Range	4KW	
	Resolution	0.1W	
	Accuracy	$\pm(0.2\%+0.2\%FS)$	
Protection range			
Overpower protection	$\approx 4.04KW$		
Overcurrent protection	$\approx 17.6A$	$\approx 176A$	
Overvoltage protection	$\approx 1250V$		
Overtemperature protection	$\approx 85^{\circ}C$		
Specification			
Short circuit	Current (CC)	$\approx 17.6A$	$\approx 176A$
	Voltage (CV)	$\approx 0V$	$\approx 0V$
	Resistance (CR)	$\approx 75m\Omega$	
Input terminal impedance	$\approx 1.8M\Omega$		
Height	4U		
Weight	34 Kg		
AC Input	Voltage	100~240Vac	
	Frequency	50/60Hz	
	Power	200VA max	

\*1.The voltage/current input is no less than 10%FS (FS indicates the full scope).

\*2.The scope of read-back resistance is  $(1/(1/R+(1/R)*0.01\%+0.08), 1/(1/R-(1/R)*0.01\%-0.08))$ .

\*3.The voltage/current input is no less than 10%FS.

\*4.The load current value is no less than 4% of FS\_CCH.

### 4.1.10 IT8904E-150-400

Model		IT8904E-150-400	
Rated value ( 0~40 °C)	Input voltage	0~150V	
	Input current	0~40A	0~400A
	Input power	4KW	
	Min. operating voltage	0.18V/40A	1.8V/400A
Constant voltage mode	Range	0.1~18V	0.1~150V
	Resolution	1mV	10mV
	Accuracy	$\pm(0.05\%+0.05\%FS)$	$\pm(0.05\%+0.05\%FS)$
Constant current mode	Range	0~40A	0~400A
	Resolution	1mA	10mA
	Accuracy	$\pm(0.1\%+0.1\%FS)$	$\pm(0.1\%+0.1\%FS)$
Constant resistance mode*1	Range	0.005Ω~10Ω	10Ω~7.5KΩ
	Resolution	16bit	
	Accuracy	0.01%+0.08S *2	0.01%+0.0008S
Constant power Mode*3	Range	4KW	
	Resolution	0.1W	
	Accuracy	0.2%+0.3%FS	
Dynamic Mode			
Dynamic Mode*4	CC Mode		
	T1 & T2	20uS~3600S /Res:1 us/10ms/100ms	
	Accuracy	5uS±100ppm	
	Ascending/descending slope	0.001~0.48A/uS	0.01~4.8A/uS
Measuring range			
Read-back voltage	Range	0~18V	0~150V
	Resolution	1mV	10mV
	Accuracy	$\pm(0.025\%+0.025\%FS)$	$\pm(0.025\%+0.025\%FS)$
Read-back current	Range	0~40A	0~400A
	Resolution	1mA	10mA
	Accuracy	$\pm(0.1\%+0.1\%FS)$	$\pm(0.1\%+0.1\%FS)$
Read-back power*2	Range	4KW	
	Resolution	0.1W	

Model		IT8904E-150-400	
	Accuracy	$\pm(0.2\%+0.3\%FS)$	
Protection range			
Overpower protection	$\approx 4.04KW$		
Overcurrent protection	$\approx 42A$	$\approx 420A$	
Overvoltage protection	$\approx 157V$		
Overtemperature protection	$\approx 85^{\circ}C$		
Specification			
Short circuit	Current (CC)	$\approx 42A$	$\approx 420A$
	Voltage (CV)	$\approx 0V$	$\approx 0V$
	Resistance (CR)	$\approx 4.5m\Omega$	
Input terminal impedance	$\approx 800K\Omega$		
Height	4U		
Weight	34 Kg		
AC Input	Voltage	100~240Vac	
	Frequency	50/60Hz	
	Power	200VA max	

\*1.The voltage/current input is no less than 10%FS (FS indicates the full scope).

\*2.The scope of read-back resistance is  $(1/(1/R+(1/R)*0.01\%+0.08), 1/(1/R-(1/R)*0.01\%-0.08))$ .

\*3.The voltage/current input is no less than 10%FS.

\*4.The load current value is no less than 4% of FS\_CCH.

#### 4.1.11 IT8904E-600-280

Model		IT8904E-600-280	
Rated value ( 0~40 °C)	Input voltage	0~600V	
	Input current	0~28A	0~280A
	Input power	4KW	

Model		IT8904E-600-280	
	Min. operating voltage	0.42V/28A	4.2V/280A
Constant voltage mode	Range	0.1~60V	0.1~600V
	Resolution	1mV	10mV
	Accuracy	±(0.05%+0.05%FS)	±(0.05%+0.05%FS)
Constant current mode	Range	0~28A	0~280A
	Resolution	1mA	10mA
	Accuracy	±(0.1%+0.1%FS)	±(0.1%+0.1%FS)
Constant resistance mode*1	Range	0.02Ω~10Ω	10Ω~7.5KΩ
	Resolution	16bit	
	Accuracy	0.01%+0.08S *2	0.01%+0.0008S
Constant power Mode*3	Range	4KW	
	Resolution	0.1W	
	Accuracy	0.2%+0.3%FS	
Dynamic Mode			
Dynamic Mode*4	CC Mode		
	T1 & T2	20uS~3600S /Res:1 us/10ms/100ms	
	Accuracy	5uS±100ppm	
	Ascending/descending slope	0.001~0.32A/uS	0.01~3.2A/uS
Measuring range			
Read-back voltage	Range	0~60V	0~600V
	Resolution	1mV	10mV
	Accuracy	±(0.025%+0.025%FS)	±(0.025%+0.025%FS)
Read-back current	Range	0~28A	0~280A
	Resolution	1mA	10mA
	Accuracy	±(0.1%+0.1%FS)	±(0.1%+0.1%FS)
Read-back power*2	Range	4KW	
	Resolution	0.1W	
	Accuracy	±(0.2%+0.3%FS)	
Protection range			
Overpower protection	≈4.04KW		

Model		IT8904E-600-280	
Overcurrent protection		$\approx 29.4A$	$\approx 294A$
Overvoltage protection		$\approx 630V$	
Overtemperature protection		$\approx 85^{\circ}C$	
Specification			
Short circuit	Current (CC)	$\approx 29.4A$	$\approx 294A$
	Voltage (CV)	$\approx 0V$	$\approx 0V$
	Resistance (CR)	$\approx 15m\Omega$	
Input terminal impedance		$\approx 1M\Omega$	
Height		4U	
Weight		34 Kg	
AC Input	Voltage	100~240Vac	
	Frequency	50/60Hz	
	Power	200VA max	

\*1.The voltage/current input is no less than 10%FS (FS indicates the full scope).

\*2.The scope of read-back resistance is  $(1/(1/R+(1/R)*0.01\%+0.08), 1/(1/R-(1/R)*0.01\%-0.08))$ .

\*3.The voltage/current input is no less than 10%FS.

\*4.The load current value is no less than 4% of FS\_CCH.

#### 4.1.12 IT8904E-1200-160

Model		IT8904E-1200-160	
Rated value ( 0~40 °C)	Input voltage	0~1200V	
	Input current	0~16A	0~160A
	Input power	4KW	
	Min. operating voltage	1.2V/16A	12V/160A
Constant voltage mode	Range	0.1~120V	0.1~1200V
	Resolution	10mV	100mV
	Accuracy	$\pm(0.05\%+0.05\%FS)$	$\pm(0.05\%+0.05\%FS)$

Model		IT8904E-1200-160	
Constant current mode	Range	0~16A	0~160A
	Resolution	1mA	10mA
	Accuracy	$\pm(0.1\%+0.1\%FS)$	$\pm(0.1\%+0.1\%FS)$
Constant resistance mode*1	Range	0.1 $\Omega$ ~10 $\Omega$	10 $\Omega$ ~7.5K $\Omega$
	Resolution	16bit	
	Accuracy	0.01%+0.08S *2	0.01%+0.0008S
Constant power Mode*3	Range	4KW	
	Resolution	0.1W	
	Accuracy	0.2%+0.3%FS	
Dynamic Mode			
Dynamic Mode*4	CC Mode		
	T1 & T2	20 $\mu$ S~3600S /Res:1 $\mu$ s/10ms/100ms	
	Accuracy	5 $\mu$ S $\pm$ 100ppm	
	Ascending/descending slope	0.001~0.16A/ $\mu$ S	0.01~1.6A/ $\mu$ S
Measuring range			
Read-back voltage	Range	0~120V	0~1200V
	Resolution	10mV	100mV
	Accuracy	$\pm(0.025\%+0.025\%FS)$	$\pm(0.025\%+0.025\%FS)$
Read-back current	Range	0~16A	0~160A
	Resolution	1mA	10mA
	Accuracy	$\pm(0.1\%+0.1\%FS)$	$\pm(0.1\%+0.1\%FS)$
Read-back power*2	Range	4KW	
	Resolution	0.1W	
	Accuracy	$\pm(0.2\%+0.3\%FS)$	
Protection range			
Overpower protection	$\approx$ 4.04KW		
Overcurrent protection	$\approx$ 17.6A	$\approx$ 176A	
Overvoltage protection	$\approx$ 1250V		
Overtemperature protection	$\approx$ 85 $^{\circ}$ C		

Model		IT8904E-1200-160	
Specification			
Short circuit	Current (CC)	$\approx 17.6A$	$\approx 176A$
	Voltage (CV)	$\approx 0V$	$\approx 0V$
	Resistance (CR)	$\approx 75m\Omega$	$\approx 75m\Omega$
Input terminal impedance	$\approx 1.8M\Omega$		
Height	4U		
Weight	34 Kg		
AC Input	Voltage	100~240Vac	
	Frequency	50/60Hz	
	Power	250VA max	

\*1.The voltage/current input is no less than 10%FS (FS indicates the full scope).

\*2.The scope of read-back resistance is  $(1/(1/R+(1/R)*0.01\%+0.08), 1/(1/R-(1/R)*0.01\%-0.08))$ .

\*3.The voltage/current input is no less than 10%FS.

\*4.The load current value is no less than 4% of FS\_CCH.

### 4.1.13 IT8906A-150-600

Model		IT8906A-150-600	
Rated value ( 0~40 °C)	Input voltage	0~150V	
	Input current	0~60A	0~600A
	Input power	6KW	
	Min. operating voltage	0.18V/60A	1.8V/600A
Constant voltage mode	Range	0.1~18V	0.1~150V
	Resolution	1mV	10mV
	Accuracy	$\pm(0.05\%+0.05\%FS)$	$\pm(0.05\%+0.05\%FS)$
Constant current mode	Range	0~60A	0~600A
	Resolution	1mA	10mA
	Accuracy	$\pm(0.05\%+0.1\%FS)$	$\pm(0.05\%+0.1\%FS)$
Constant resistance mode*1	Range	0.005 $\Omega$ ~10 $\Omega$	10 $\Omega$ ~7.5K $\Omega$



Model		IT8906A-150-600	
	Resolution	16bit	
	Accuracy	0.01%+0.08S *2	0.01%+0.0008S
Constant power Mode*3	Range	6KW	
	Resolution	0.1W	
	Accuracy	0.2%+0.2%FS	
Dynamic Mode			
Dynamic Mode*4	CC Mode		
	T1 & T2	20uS~3600S /Res:1 us/10ms/100ms	
	Accuracy	5uS±100ppm	
	Ascending/descending slope	0.001~1.2A/uS	0.01~12A/uS
	Min. rise time	≈12uS	≈12uS
Measuring range			
Read-back voltage	Range	0~18V	0~150V
	Resolution	1mV	10mV
	Accuracy	±(0.025%+0.025%FS)	±(0.025%+0.025%FS)
Read-back current	Range	0~60A	0~600A
	Resolution	1mA	10mA
	Accuracy	±(0.05%+0.1%FS)	±(0.05%+0.1%FS)
Read-back power*2	Range	6KW	
	Resolution	0.1W	
	Accuracy	±(0.2%+0.2%FS)	
Protection range			
Overpower protection	≈6.05KW		
Overcurrent protection	≈63A	≈630A	
Overvoltage protection	≈157V		
Overtemperature protection	≈85°C		
Specification			
Short circuit	Current (CC)	≈63A	≈630A
	Voltage (CV)	≈0V	≈0V

Model		IT8906A-150-600	
	Resistance (CR)	≈3mΩ	
Input terminal impedance		≈800KΩ	
Height		4U	
Weight		40 Kg	
AC Input	Voltage	100~240Vac	
	Frequency	50/60Hz	
	Power	250VA max	

\*1.The voltage/current input is no less than 10%FS (FS indicates the full scope).

\*2.The scope of read-back resistance is  $(1/(1/R+(1/R)*0.01\%+0.08), 1/(1/R-(1/R)*0.01\%-0.08))$ .

\*3.The voltage/current input is no less than 10%FS.

\*4.The load current value is no less than 4% of FS\_CCH.

#### 4.1.14 IT8906A-600-420

Model		IT8906A-600-420	
Rated value ( 0~40 °C)	Input voltage	0~600V	
	Input current	0~42A	0~420A
	Input power	6KW	
	Min. operating voltage	0.42V/42A	4.2V/420A
Constant voltage mode	Range	0.1~60V	0.1~600V
	Resolution	1mV	10mV
	Accuracy	±(0.05%+0.05%FS)	±(0.05%+0.05%FS)
Constant current mode	Range	0~42A	0~420A
	Resolution	1mA	10mA
	Accuracy	±(0.05%+0.1%FS)	±(0.05%+0.1%FS)
Constant resistance mode*1	Range	0.02Ω~10Ω	10Ω~7.5KΩ
	Resolution	16bit	
	Accuracy	0.01%+0.08S *2	0.01%+0.0008S
Constant power Mode*3	Range	6KW	
	Resolution	0.1W	

Model		IT8906A-600-420	
	Accuracy	0.2%+0.2%FS	
Dynamic Mode			
Dynamic Mode*4	CC Mode		
	T1 & T2	20uS~3600S /Res:1 us/10ms/100ms	
	Accuracy	5uS±100ppm	
	Ascending/descending slope	0.001~0.6A/uS	0.01~6 A/uS
	Min. rise time	≈20uS	≈20uS
Measuring range			
Read-back voltage	Range	0~60V	0~600V
	Resolution	1mV	10mV
	Accuracy	±(0.025%+0.025%FS)	±(0.025%+0.025%FS)
Read-back current	Range	0~42A	0~420A
	Resolution	1mA	10mA
	Accuracy	±(0.05%+0.1%FS)	±(0.05%+0.1%FS)
Read-back power*2	Range	6KW	
	Resolution	0.1W	
	Accuracy	±(0.2%+0.2%FS)	
Protection range			
Overpower protection	≈6.05KW		
Overcurrent protection	≈44A	≈440A	
Overvoltage protection	≈630V		
Overtemperature protection	≈85°C		
Specification			
Short circuit	Current (CC)	≈44A	≈440A
	Voltage (CV)	≈0V	≈0V
	Resistance (CR)	≈10mΩ	
Input terminal impedance	≈1MΩ		
Height	4U		
Weight	40 Kg		

Model		IT8906A-600-420
AC Input	Voltage	100~240Vac
	Frequency	50/60Hz
	Power	250VA max

\*1.The voltage/current input is no less than 10%FS (FS indicates the full scope).

\*2.The scope of read-back resistance is  $(1/(1/R+(1/R)*0.01\%+0.08), 1/(1/R-(1/R)*0.01\%-0.08))$ .

\*3.The voltage/current input is no less than 10%FS.

\*4.The load current value is no less than 4% of FS\_CCH.

### 4.1.15 IT8906A-1200-240

Model		IT8906A-1200-240	
Rated value ( 0~40 °C)	Input voltage	0~1200V	
	Input current	0~24A	0~240A
	Input power	6KW	
	Min. operating voltage	1.2V/24A	12V/240A
Constant voltage mode	Range	0.1~120V	0.1~1200V
	Resolution	10mV	100mV
	Accuracy	$\pm(0.05\%+0.05\%FS)$	$\pm(0.05\%+0.05\%FS)$
Constant current mode	Range	0~24A	0~240A
	Resolution	1mA	10mA
	Accuracy	$\pm(0.05\%+0.1\%FS)$	$\pm(0.05\%+0.1\%FS)$
Constant resistance mode*1	Range	0.1Ω~10Ω	10Ω~7.5KΩ
	Resolution	16bit	
	Accuracy	0.01%+0.08S *2	0.01%+0.0008S
Constant power Mode*3	Range	6KW	
	Resolution	0.1W	
	Accuracy	0.2%+0.2%FS	
Dynamic Mode			
Dynamic Mode*4	CC Mode		
	T1 & T2	20uS~3600S /Res:1 us/10ms/100ms	

Model		IT8906A-1200-240	
	Accuracy	5uS±100ppm	
	Ascending/descending slope	0.001~0.3A/uS	0.01~3 A/uS
	Min. rise time	≈30uS	≈30uS
Measuring range			
Read-back voltage	Range	0~120V	0~1200V
	Resolution	10mV	100mV
	Accuracy	±(0.025%+0.025%FS)	±(0.025%+0.025%FS)
Read-back current	Range	0~24A	0~240A
	Resolution	1mA	10mA
	Accuracy	±(0.05%+0.1%FS)	±(0.05%+0.1%FS)
Read-back power*2	Range	6KW	
	Resolution	0.1W	
	Accuracy	±(0.2%+0.2%FS)	
Protection range			
Overpower protection	≈6.05KW		
Overcurrent protection	≈25.2A	≈252A	
Overvoltage protection	≈1250V		
Overtemperature protection	≈85°C		
Specification			
Short circuit	Current (CC)	≈25.2A	≈252A
	Voltage (CV)	≈0V	≈0V
	Resistance (CR)	≈50mΩ	≈50mΩ
Input terminal impedance	≈1.6MΩ		
Height	4U		
Weight	40 Kg		
AC Input	Voltage	100~240Vac	
	Frequency	50/60Hz	
	Power	250VA max	

\*1.The voltage/current input is no less than 10%FS (FS indicates the full scope).

\*2.The scope of read-back resistance is  $(1/(1/R+(1/R)*0.01\%+0.08), 1/(1/R-(1/R)*0.01\%-0.08))$ .

\*3.The voltage/current input is no less than 10%FS.

\*4.The load current value is no less than 4% of FS\_CCH.

## 4.1.16 IT8906E-150-600

Model		IT8906E-150-600	
Rated value ( 0~40 °C)	Input voltage	0~150V	
	Input current	0~60A	0~600A
	Input power	6KW	
	Min. operating voltage	0.18V/60A	1.8V/600A
Constant voltage mode	Range	0.1~18V	0.1~150V
	Resolution	1mV	10mV
	Accuracy	$\pm(0.05\%+0.05\%FS)$	$\pm(0.05\%+0.05\%FS)$
Constant current mode	Range	0~60A	0~600A
	Resolution	1mA	10mA
	Accuracy	$\pm(0.1\%+0.1\%FS)$	$\pm(0.1\%+0.1\%FS)$
Constant resistance mode*1	Range	0.005Ω~10Ω	10Ω~7.5KΩ
	Resolution	16bit	
	Accuracy	0.01%+0.08S *2	0.01%+0.0008S
Constant power Mode*3	Range	6KW	
	Resolution	0.1W	
	Accuracy	0.2%+0.3%FS	
Dynamic Mode			
Dynamic Mode*4	CC Mode		
	T1 & T2	20uS~3600S /Res:1 us/10ms/100ms	
	Accuracy	5uS±100ppm	
	Ascending/descending slope	0.001~0.72A/uS	0.01~7.2A/uS
Measuring range			
Read-back voltage	Range	0~18V	0~150V
	Resolution	1mV	10mV

Model		IT8906E-150-600	
	Accuracy	$\pm(0.025\%+0.025\%FS)$	$\pm(0.025\%+0.025\%FS)$
Read-back current	Range	0~60A	0~600A
	Resolution	1mA	10mA
	Accuracy	$\pm(0.1\%+0.1\%FS)$	$\pm(0.1\%+0.1\%FS)$
Read-back power*2	Range	6KW	
	Resolution	0.1W	
	Accuracy	$\pm(0.2\%+0.3\%FS)$	
Protection range			
Overpower protection	$\approx 6.06KW$		
Overcurrent protection	$\approx 63A$	$\approx 630A$	
Overvoltage protection	$\approx 157V$		
Overtemperature protection	$\approx 85^{\circ}C$		
Specification			
Short circuit	Current (CC)	$\approx 63A$	$\approx 630A$
	Voltage (CV)	$\approx 0V$	$\approx 0V$
	Resistance (CR)	$\approx 3m\Omega$	
Input terminal impedance	$\approx 800K\Omega$		
Height	4U		
Weight	40 Kg		
AC Input	Voltage	100~240Vac	
	Frequency	50/60Hz	
	Power	250VA max	

\*1.The voltage/current input is no less than 10%FS (FS indicates the full scope).

\*2.The scope of read-back resistance is  $(1/(1/R+(1/R)*0.01\%+0.08), 1/(1/R-(1/R)*0.01\%-0.08))$ .

\*3.The voltage/current input is no less than 10%FS.

\*4.The load current value is no less than 4% of FS\_CCH.

### 4.1.17 IT8906E-600-420

Model		IT8906E-600-420	
Rated value ( 0~40 °C)	Input voltage	0~600V	
	Input current	0~42A	0~420A
	Input power	6KW	
	Min. operating voltage	0.42V/42A	4.2V/420A
Constant voltage mode	Range	0.1~60V	0.1~600V
	Resolution	1mV	10mV
	Accuracy	±(0.05%+0.05%FS)	±(0.05%+0.05%FS)
Constant current mode	Range	0~42A	0~420A
	Resolution	1mA	10mA
	Accuracy	±(0.1%+0.1%FS)	±(0.1%+0.1%FS)
Constant resistance mode*1	Range	0.02Ω~10Ω	10Ω~7.5KΩ
	Resolution	16bit	
	Accuracy	0.01%+0.08S *2	0.01%+0.0008S
Constant power Mode*3	Range	6KW	
	Resolution	0.1W	
	Accuracy	0.2%+0.3%FS	
Dynamic Mode			
Dynamic Mode*4	CC Mode		
	T1 & T2	20uS~3600S /Res:1 us/10ms/100ms	
	Accuracy	5uS±100ppm	
	Ascending/descending slope	0.001~0.48A/uS	0.01~4.8A/uS
Measuring range			
Read-back voltage	Range	0~60V	0~600V
	Resolution	1mV	10mV
	Accuracy	±(0.025%+0.025%FS)	±(0.025%+0.025%FS)
Read-back current	Range	0~42A	0~420A
	Resolution	1mA	10mA
	Accuracy	±(0.1%+0.1%FS)	±(0.1%+0.1%FS)
Read-back power*2	Range	6KW	
	Resolution	0.1W	



Model		IT8906E-600-420	
	Accuracy	$\pm(0.2\%+0.3\%FS)$	
Protection range			
Overpower protection	$\approx 6.06KW$		
Overcurrent protection	$\approx 44A$	$\approx 440A$	
Overvoltage protection	$\approx 630V$		
Overtemperature protection	$\approx 85^{\circ}C$		
Specification			
Short circuit	Current (CC)	$\approx 44A$	$\approx 440A$
	Voltage (CV)	$\approx 0V$	$\approx 0V$
	Resistance (CR)	$\approx 10m\Omega$	$\approx 10m\Omega$
Input terminal impedance	$\approx 1M\Omega$		
Height	4U		
Weight	40 Kg		
AC Input	Voltage	100~240Vac	
	Frequency	50/60Hz	
	Power	250VA max	

\*1.The voltage/current input is no less than 10%FS (FS indicates the full scope).

\*2.The scope of read-back resistance is  $(1/(1/R+(1/R)*0.01\%+0.08), 1/(1/R-(1/R)*0.01\%-0.08))$ .

\*3.The voltage/current input is no less than 10%FS.

\*4.The load current value is no less than 4% of FS\_CCH.

#### 4.1.18 IT8906E-1200-240

Model		IT8906E-1200-240	
Rated value ( 0~40 °C)	Input voltage	0~1200V	
	Input current	0~24A	0~240A
	Input power	6KW	

Model		IT8906E-1200-240	
	Min. operating voltage	1.2V/24A	12V/240A
Constant voltage mode	Range	0.1~120V	0.1~1200V
	Resolution	10mV	100mV
	Accuracy	±(0.05%+0.05%FS)	±(0.05%+0.05%FS)
Constant current mode	Range	0~24A	0~240A
	Resolution	1mA	10mA
	Accuracy	±(0.1%+0.1%FS)	±(0.1%+0.1%FS)
Constant resistance mode*1	Range	0.1Ω~10Ω	10Ω~7.5KΩ
	Resolution	16bit	
	Accuracy	0.01%+0.08S *2	0.01%+0.0008S
Constant power Mode*3	Range	6KW	
	Resolution	0.1W	
	Accuracy	0.2%+0.3%FS	
Dynamic Mode			
Dynamic Mode*4	CC Mode		
	T1 & T2	20uS~3600S /Res:1 us/10ms/100ms	
	Accuracy	5uS±100ppm	
	Ascending/descending slope	0.001~0.25A/uS	0.01~2.5A/uS
Measuring range			
Read-back voltage	Range	0~120V	0~1200V
	Resolution	10mV	100mV
	Accuracy	±(0.025%+0.025%FS)	±(0.025%+0.025%FS)
Read-back current	Range	0~24A	0~240A
	Resolution	1mA	10mA
	Accuracy	±(0.1%+0.1%FS)	±(0.1%+0.1%FS)
Read-back power*2	Range	6KW	
	Resolution	0.1W	
	Accuracy	±(0.2%+0.3%FS)	
Protection range			
Overpower protection	≈6.05KW		

Model		IT8906E-1200-240	
Overcurrent protection		$\approx 25.2A$	$\approx 252A$
Overvoltage protection		$\approx 1250V$	
Overtemperature protection		$\approx 85^{\circ}C$	
Specification			
Short circuit	Current (CC)	$\approx 25.2A$	$\approx 252A$
	Voltage (CV)	$\approx 0V$	$\approx 0V$
	Resistance (CR)	$\approx 50m\Omega$	$\approx 50m\Omega$
Input terminal impedance		$\approx 1.6M\Omega$	
Height		4U	
Weight		40 Kg	
AC Input	Voltage	100~240Vac	
	Frequency	50/60Hz	
	Power	250VA max	

\*1.The voltage/current input is no less than 10%FS (FS indicates the full scope).

\*2.The scope of read-back resistance is  $(1/(1/R+(1/R)*0.01\%+0.08), 1/(1/R-(1/R)*0.01\%-0.08))$ .

\*3.The voltage/current input is no less than 10%FS.

\*4.The load current value is no less than 4% of FS\_CCH.

#### 4.1.19 IT8912A-150-1200

Model		IT8912A-150-1200	
Rated value ( 0~40 °C)	Input voltage	0~150V	
	Input current	0~120A	0~1200A
	Input power	12KW	
	Min. operating voltage	0.18V/120A	1.8V/1200A
Constant voltage mode	Range	0.1~18V	0.1~150V
	Resolution	1mV	10mV
	Accuracy	$\pm(0.05\%+0.05\%FS)$	$\pm(0.05\%+0.05\%FS)$

Model		IT8912A-150-1200	
Constant current mode	Range	0~120A	0~1200A
	Resolution	10mA	100mA
	Accuracy	$\pm(0.05\%+0.1\%FS)$	$\pm(0.05\%+0.1\%FS)$
Constant resistance mode *1	Range	0.005 $\Omega$ ~10 $\Omega$	10 $\Omega$ ~7.5K $\Omega$
	Resolution	16bit	
	Accuracy	0.01%+0.08S *2	0.01%+0.0008S
Constant power Mode *3	Range	12KW	
	Resolution	1W	
	Accuracy	0.2%+0.2%FS	
Dynamic Mode			
Dynamic Mode *4	CC Mode		
	Ascending/descending slope	0.01~2.4A/uS	0.1~24A/uS
Measuring range			
Read-back voltage	Range	0~18V	0~150V
	Resolution	1mV	10mV
	Accuracy	$\pm(0.025\%+0.025\%FS)$	$\pm(0.025\%+0.025\%FS)$
Read-back current	Range	0~120A	0~1200A
	Resolution	10mA	100mA
	Accuracy	$\pm(0.05\%+0.1\%FS)$	$\pm(0.05\%+0.1\%FS)$
Read-back power *2	Range	12KW	
	Resolution	1W	
	Accuracy	$\pm(0.2\%+0.2\%FS)$	
Protection range			
Overpower protection	$\approx 12.1KW$		
Overcurrent protection	$\approx 126A$	$\approx 1260A$	
Overvoltage protection	$\approx 157V$		
Overtemperature protection	$\approx 85^{\circ}C$		
Specification			
Short circuit	Current (CC)	$\approx 126A$	$\approx 1260A$

Model		IT8912A-150-1200	
	Voltage (CV)	≒0V	≒0V
	Resistance (CR)	≒1.5mΩ	
Input terminal impedance	≒400KΩ		
Height	8U		

\*1. The voltage/current input is no less than 10%FS (FS indicates the full scope).

\*2. The scope of read-back resistance is  $(1/(1/R+(1/R)*0.01\%+0.08), 1/(1/R-(1/R)*0.01\%-0.08))$ .

\*3. The voltage/current input is no less than 10%FS.

## 4.1.20 IT8912A-600-840

Model		IT8912A-600-840	
Rated value ( 0~40 °C)	Input voltage	0~600V	
	Input current	0~84A	0~840A
	Input power	12KW	
	Min. operating voltage	0.42V/84A	4.2V/840A
Constant voltage mode	Range	0.1~60V	0.1~600V
	Resolution	1mV	10mV
	Accuracy	±(0.05%+0.05%FS)	±(0.05%+0.05%FS)
Constant current mode	Range	0~84A	0~840A
	Resolution	1mA	10mA
	Accuracy	±(0.05%+0.1%FS)	±(0.05%+0.1%FS)
Constant resistance mode *1	Range	0.005Ω~10Ω	10Ω~7.5KΩ
	Resolution	16bit	
	Accuracy	0.01%+0.08S *2	0.01%+0.0008S
Constant power Mode *3	Range	12KW	
	Resolution	1W	
	Accuracy	0.2%+0.2%FS	
Dynamic Mode			
Dynamic Mode *4	CC Mode		

Model		IT8912A-600-840	
	Ascending/de- scending slope	0.001~1.2A/uS	0.01~12 A/uS
Measuring range			
Read-back voltage	Range	0~60V	0~600V
	Resolution	1mV	10mV
	Accuracy	$\pm(0.025\%+0.025\%FS)$	$\pm(0.025\%+0.025\%FS)$
Read-back current	Range	0~84A	0~840A
	Resolution	1mA	10mA
	Accuracy	$\pm(0.05\%+0.1\%FS)$	$\pm(0.05\%+0.1\%FS)$
Read-back power *2	Range	12KW	
	Resolution	1W	
	Accuracy	$\pm(0.2\%+0.2\%FS)$	
Protection range			
Overpower protection	$\approx 12.1KW$		
Overcurrent protection	$\approx 88A$	$\approx 880A$	
Overvoltage protection	$\approx 630V$		
Overtemperature protection	$\approx 85^{\circ}C$		
Specification			
Short circuit	Current (CC)	$\approx 88A$	$\approx 880A$
	Voltage (CV)	$\approx 0V$	$\approx 0V$
	Resistance (CR)	$\approx 5m\Omega$	
Input terminal impedance	$\approx 500K\Omega$		
Height	8U		

\*1. The voltage/current input is no less than 10%FS (FS indicates the full scope).

\*2. The scope of read-back resistance is  $(1/(1/R+(1/R)*0.01\%+0.08), 1/(1/R-(1/R)*0.01\%-0.08))$ .

\*3. The voltage/current input is no less than 10%FS.

## 4.1.21 IT8912A-1200-480

Model		IT8912A-1200-480	
Rated value ( 040 °C)	Input voltage	0~1200V	
	Input current	0~48A	0~480A
	Input power	12KW	
	Min. operating voltage	1.2V/48A	12V/480A
Constant voltage mode	Range	0.1~120V	0.1~1200V
	Resolution	10mV	100mV
	Accuracy	$\pm(0.05\%+0.05\%FS)$	$\pm(0.05\%+0.05\%FS)$
Constant current mode	Range	0~48A	0~480A
	Resolution	1mA	10mA
	Accuracy	$\pm(0.05\%+0.1\%FS)$	$\pm(0.05\%+0.1\%FS)$
Constant resistance mode*1	Range	0.05Ω~10Ω	10Ω~7.5KΩ
	Resolution	16bit	
	Accuracy	0.01%+0.08S *2	0.01%+0.0008S
Constant power Mode*3	Range	12KW	
	Resolution	1W	
	Accuracy	0.2%+0.2%FS	
Dynamic Mode			
Dynamic Mode*4	CC Mode		
	Ascending/descending slope	0.001~0.6A/uS	0.01~6 A/uS
Measuring range			
Read-back voltage	Range	0~120V	0~1200V
	Resolution	10mV	100mV
	Accuracy	$\pm(0.025\%+0.025\%FS)$	$\pm(0.025\%+0.025\%FS)$
Read-back current	Range	0~48A	0~480A
	Resolution	1mA	10mA
	Accuracy	$\pm(0.05\%+0.1\%FS)$	$\pm(0.05\%+0.1\%FS)$
Read-back power*2	Range	12KW	
	Resolution	1W	
	Accuracy	$\pm(0.2\%+0.2\%FS)$	
Protection range			

Model		IT8912A-1200-480	
Overpower protection	≈12.1KW		
Overcurrent protection	≈50A	≈500A	
Overvoltage protection	≈1250V		
Overtemperature protection	≈85°C		
Specification			
Short circuit	Current (CC)	≈50A	≈500A
	Voltage (CV)	0V	0V
	Resistance (CR)	≈25mΩ	
Input terminal impedance	≈800KΩ		
Height	8U		

\*1.The voltage/current input is no less than 10%FS (FS indicates the full scope).

\*2.The scope of read-back resistance is  $(1/(1/R+(1/R)*0.01\%+0.08), 1/(1/R-(1/R)*0.01\%-0.08))$ .

\*3.The voltage/current input is no less than 10%FS.

\*4.The load current value is no less than 4% of FS\_CCH.

## 4.1.22 IT8912E-150-1200

Model		IT8912E-150-1200	
Rated value ( 040 °C)	Input voltage	0~150V	
	Input current	0~120A	0~1200A
	Input power	12KW	
	Min. operating voltage	0.18V/120A	1.8V/1200A
Constant voltage mode	Range	0.1~18V	0.1~150V
	Resolution	1mV	10mV
	Accuracy	±(0.05%+0.05%FS)	±(0.05%+0.05%FS)
Constant current mode	Range	0~120A	0~1200A
	Resolution	10mA	100mA



Model		IT8912E-150-1200	
	Accuracy	$\pm(0.1\%+0.1\%FS)$	$\pm(0.1\%+0.1\%FS)$
Constant resistance mode*1	Range	0.005 $\Omega$ ~10 $\Omega$	10 $\Omega$ ~7.5K $\Omega$
	Resolution	16bit	
	Accuracy	0.01%+0.08S *2	0.01%+0.0008S
Constant power Mode*3	Range	12KW	
	Resolution	1W	
	Accuracy	0.2%+0.3%FS	
Dynamic Mode			
Dynamic Mode*4	CC Mode		
	Ascending/descending slope	0.01~1.44A/uS	0.1~14.4A/uS
Measuring range			
Read-back voltage	Range	0~18V	0~150V
	Resolution	1mV	10mV
	Accuracy	$\pm(0.025\%+0.025\%FS)$	$\pm(0.025\%+0.025\%FS)$
Read-back current	Range	0~120A	0~1200A
	Resolution	10mA	100mA
	Accuracy	$\pm(0.1\%+0.1\%FS)$	$\pm(0.1\%+0.1\%FS)$
Read-back power*2	Range	12KW	
	Resolution	1W	
	Accuracy	$\pm(0.2\%+0.3\%FS)$	
Protection range			
Overpower protection	$\cong 12.1KW$		
Overcurrent protection	$\cong 126A$	$\cong 1260A$	
Overvoltage protection	$\cong 157V$		
Overtemperature protection	$\cong 85^{\circ}C$		
Specification			
Short circuit	Current (CC)	$\cong 126A$	$\cong 1260A$
	Voltage (CV)	$\cong 0V$	$\cong 0V$
	Resistance (CR)	$\cong 1.5m\Omega$	

Model	IT8912E-150-1200
Input terminal impedance	$\approx 400\text{K}\Omega$
Height	8U

\*1. The voltage/current input is no less than 10%FS (FS indicates the full scope).

\*2. The scope of read-back resistance is  $(1/(1/R+(1/R)*0.01\%+0.08), 1/(1/R-(1/R)*0.01\%-0.08))$ .

\*3. The voltage/current input is no less than 10%FS.

\*4. The load current value is no less than 4% of FS\_CCH.

### 4.1.23 IT8912E-600-840

Model	IT8912E-600-840	
Rated value ( 040 °C)	Input voltage	0~600V
	Input current	0~84A      0~840A
	Input power	12KW
	Min. operating voltage	0.42V/84A      4.2V/840A
Constant voltage mode	Range	0.1~60V      0.1~600V
	Resolution	1mV      10mV
	Accuracy	$\pm(0.05\%+0.05\%FS)$ $\pm(0.05\%+0.05\%FS)$
Constant current mode	Range	0~84A      0~840A
	Resolution	1mA      10mA
	Accuracy	$\pm(0.1\%+0.1\%FS)$ $\pm(0.1\%+0.1\%FS)$
Constant resistance mode*1	Range	0.005 $\Omega$ ~10 $\Omega$ 10 $\Omega$ ~7.5K $\Omega$
	Resolution	16bit
	Accuracy	0.01%+0.08S *2      0.01%+0.0008S
Constant power Mode*3	Range	12KW
	Resolution	1W
	Accuracy	0.2%+0.3%FS
Dynamic Mode		
Dynamic Mode*4	CC Mode	

Model		IT8912E-600-840	
	Ascending/descending slope	0.001~0.96A/uS	0.01~9.6A/uS
Measuring range			
Read-back voltage	Range	0~60V	0~600V
	Resolution	1mV	10mV
	Accuracy	$\pm(0.025\%+0.025\%FS)$	$\pm(0.025\%+0.025\%FS)$
Read-back current	Range	0~84A	0~840A
	Resolution	1mA	10mA
	Accuracy	$\pm(0.1\%+0.1\%FS)$	$\pm(0.1\%+0.1\%FS)$
Read-back power*2	Range	12KW	
	Resolution	1W	
	Accuracy	$\pm(0.2\%+0.3\%FS)$	
Protection range			
Overpower protection	$\approx 12.1KW$		
Overcurrent protection	$\approx 88A$	$\approx 880A$	
Overvoltage protection	$\approx 630V$		
Overtemperature protection	$\approx 85^{\circ}C$		
Specification			
Short circuit	Current (CC)	$\approx 88A$	$\approx 880A$
	Voltage (CV)	$\approx 0V$	$\approx 0V$
	Resistance (CR)	$\approx 5m\Omega$	
Input terminal impedance	$\approx 500K\Omega$		
Height	8U		

\*1. The voltage/current input is no less than 10%FS (FS indicates the full scope).

\*2. The scope of read-back resistance is  $(1/(1/R+(1/R)*0.01\%+0.08), 1/(1/R-(1/R)*0.01\%-0.08))$ .

\*3. The voltage/current input is no less than 10%FS.

\*4. The load current value is no less than 4% of FS\_CCH.

### 4.1.24 IT8912E-1200-480

Model		IT8912E-1200-480	
Rated value ( 040 °C)	Input voltage	0~1200V	
	Input current	0~48A	0~480A
	Input power	12KW	
	Min. operating voltage	1.2V/48A	12V/480A
Constant voltage mode	Range	0.1~120V	0.1~1200V
	Resolution	10mV	100mV
	Accuracy	$\pm(0.05\%+0.05\%FS)$	$\pm(0.05\%+0.05\%FS)$
Constant current mode	Range	0~48A	0~480A
	Resolution	1mA	10mA
	Accuracy	$\pm(0.1\%+0.1\%FS)$	$\pm(0.1\%+0.1\%FS)$
Constant resistance mode*1	Range	0.05Ω~10Ω	10Ω~7.5KΩ
	Resolution	16bit	
	Accuracy	0.01%+0.08S *2	0.01%+0.0008S
Constant power Mode*3	Range	12KW	
	Resolution	1W	
	Accuracy	0.2%+0.3%FS	
Dynamic Mode			
Dynamic Mode*4	CC Mode		
	Ascending/descending slope	0.001~0.5A/μS	0.01~5 A/μS
Measuring range			
Read-back voltage	Range	0~120V	0~1200V
	Resolution	10mV	100mV
	Accuracy	$\pm(0.025\%+0.025\%FS)$	$\pm(0.025\%+0.025\%FS)$
Read-back current	Range	0~48A	0~480A
	Resolution	1mA	10mA
	Accuracy	$\pm(0.1\%+0.1\%FS)$	$\pm(0.1\%+0.1\%FS)$
Read-back power*2	Range	12KW	
	Resolution	1W	
	Accuracy	$\pm(0.2\%+0.3\%FS)$	
Protection range			

Model		IT8912E-1200-480	
Overpower protection	≈12.1KW		
Overcurrent protection	≈50A	≈500A	
Overvoltage protection	≈1250V		
Overtemperature protection	≈85°C		
Specification			
Short circuit	Current (CC)	≈50A	≈500A
	Voltage (CV)	0V	0V
	Resistance (CR)	≈25mΩ	
Input terminal impedance	≈800KΩ		
Height	8U		

\*1. The voltage/current input is no less than 10%FS (FS indicates the full scope).

\*2. The scope of read-back resistance is  $(1/(1/R+(1/R)*0.01\%+0.08), 1/(1/R-(1/R)*0.01\%-0.08))$ .

\*3. The voltage/current input is no less than 10%FS.

\*4. The load current value is no less than 4% of FS\_CCH.

## 4.1.25 IT8918A-150-1800

Model		IT8918A-150-1800	
Rated value (040 °C)	Input voltage	0~150V	
	Input current	0~180A	0~1800A
	Input power	18KW	
	Min. operating voltage	0.2V/180A	2V/1800A
Constant voltage mode	Range	0.1~18V	0.1~150V
	Resolution	1mV	10mV
	Accuracy	±(0.05%+0.05%FS)	±(0.05%+0.05%FS)
Constant current mode	Range	0~180A	0~1800A

Model		IT8918A-150-1800	
	Resolution	10mA	100mA
	Accuracy	$\pm(0.05\%+0.1\%FS)$	$\pm(0.05\%+0.1\%FS)$
Constant resistance mode*1	Range	0.005 $\Omega$ ~10 $\Omega$	10 $\Omega$ ~7.5K $\Omega$
	Resolution	16bit	
	Accuracy	0.01%+0.08S *2	0.01%+0.0008S
Constant power Mode*3	Range	18KW	
	Resolution	1W	
	Accuracy	0.2%+0.2%FS	
Dynamic Mode			
Dynamic Mode*4	CC Mode		
	Ascending/descending slope	0.01~3.6A/uS	0.1~36A/uS
Measuring range			
Read-back voltage	Range	0~18V	0~150V
	Resolution	1mV	10mV
	Accuracy	$\pm(0.025\%+0.025\%FS)$	$\pm(0.025\%+0.025\%FS)$
Read-back current	Range	0~180A	0~1800A
	Resolution	10mA	100mA
	Accuracy	$\pm(0.05\%+0.1\%FS)$	$\pm(0.05\%+0.1\%FS)$
Read-back power*2	Range	18KW	
	Resolution	1W	
	Accuracy	$\pm(0.2\%+0.2\%FS)$	
Protection range			
Overpower protection	$\approx 18.1KW$		
Overcurrent protection	$\approx 189A$	$\approx 1890A$	
Overvoltage protection	$\approx 157V$		
Overtemperature protection	$\approx 85^{\circ}C$		
Specification			
Short circuit	Current (CC)	$\approx 189A$	$\approx 1890A$
	Voltage (CV)	$\approx 0V$	$\approx 0V$

Model		IT8918A-150-1800
	Resistance (CR)	$\approx 1.1\text{m}\Omega$
Input terminal impedance		$\approx 260\text{K}\Omega$
Height		15U

\*1. The voltage/current input is no less than 10%FS (FS indicates the full scope).

\*2. The scope of read-back resistance is  $(1/(1/R+(1/R)*0.01\%+0.08), 1/(1/R-(1/R)*0.01\%-0.08))$ .

\*3. The voltage/current input is no less than 10%FS.

\*4. The load current value is no less than 4% of FS\_CCH.

## 4.1.26 IT8918A-600-1260

Model		IT8918A-600-1260	
Rated value ( 040 °C)	Input voltage	0~600V	
	Input current	0~126A	0~1260A
	Input power	18KW	
	Min. operating voltage	0.5V/126A	5V/1260A
Constant voltage mode	Range	0.1~60V	0.1~600V
	Resolution	1mV	10mV
	Accuracy	$\pm(0.05\%+0.05\%FS)$	$\pm(0.05\%+0.05\%FS)$
Constant current mode	Range	0~126A	0~1260A
	Resolution	10mA	100mA
	Accuracy	$\pm(0.05\%+0.1\%FS)$	$\pm(0.05\%+0.1\%FS)$
Constant resistance mode*1	Range	0.005 $\Omega$ ~10 $\Omega$	10 $\Omega$ ~7.5K $\Omega$
	Resolution	16bit	
	Accuracy	0.01%+0.08S *2	0.01%+0.0008S
Constant power Mode*3	Range	18KW	
	Resolution	1W	
	Accuracy	0.2%+0.2%FS	
Dynamic Mode			
Dynamic Mode*4	CC Mode		

Model		IT8918A-600-1260	
	Ascending/descending slope	0.01~1.8A/uS	0.1~18 A/uS
Measuring range			
Read-back voltage	Range	0~60V	0~600V
	Resolution	1mV	10mV
	Accuracy	$\pm(0.025\%+0.025\%FS)$	$\pm(0.025\%+0.025\%FS)$
Read-back current	Range	0~126A	0~1260A
	Resolution	10mA	100mA
	Accuracy	$\pm(0.05\%+0.1\%FS)$	$\pm(0.05\%+0.1\%FS)$
Read-back power*2	Range	18KW	
	Resolution	1W	
	Accuracy	$\pm(0.2\%+0.2\%FS)$	
Protection range			
Overpower protection	$\approx 18.1KW$		
Overcurrent protection	$\approx 132A$	$\approx 1320A$	
Overvoltage protection	$\approx 630V$		
Overtemperature protection	$\approx 85^{\circ}C$		
Specification			
Short circuit	Current (CC)	$\approx 132A$	$\approx 1320A$
	Voltage (CV)	$\approx 0V$	$\approx 0V$
	Resistance (CR)	$\approx 4m\Omega$	
Input terminal impedance	$\approx 330K\Omega$		
Height	15U		

\*1. The voltage/current input is no less than 10%FS (FS indicates the full scope).

\*2. The scope of read-back resistance is  $(1/(1/R+(1/R)*0.01\%+0.08), 1/(1/R-(1/R)*0.01\%-0.08))$ .

\*3. The voltage/current input is no less than 10%FS.

\*4. The load current value is no less than 4% of FS\_CCH.



## 4.1.27 IT8918A-1200-720

Model		IT8918A-1200-720	
Rated value ( 040 °C)	Input voltage	0~1200V	
	Input current	0~72A	0~720A
	Input power	18KW	
	Min. operating voltage	1.2V/72A	12V/720A
Constant voltage mode	Range	0.1~120V	0.1~1200V
	Resolution	10mV	100mV
	Accuracy	±(0.05%+0.05%FS)	±(0.05%+0.05%FS)
Constant current mode	Range	0~72A	0~720A
	Resolution	1mA	10mA
	Accuracy	±(0.05%+0.1%FS)	±(0.05%+0.1%FS)
Constant resistance mode*1	Range	0.02Ω~10Ω	10Ω~7.5KΩ
	Resolution	16bit	
	Accuracy	0.01%+0.08S *2	0.01%+0.0008S
Constant power Mode*3	Range	18KW	
	Resolution	1W	
	Accuracy	0.2%+0.2%FS	
Dynamic Mode			
Dynamic Mode*4	CC Mode		
	Ascending/descending slope	0.001~0.9A/uS	0.01~9 A/uS
Measuring range			
Read-back voltage	Range	0~120V	0~1200V
	Resolution	10mV	100mV
	Accuracy	±(0.025%+0.025%FS)	±(0.025%+0.025%FS)
Read-back current	Range	0~72A	0~720A
	Resolution	1mA	10mA
	Accuracy	±(0.05%+0.1%FS)	±(0.05%+0.1%FS)
Read-back power*2	Range	18KW	
	Resolution	1W	
	Accuracy	±(0.2%+0.2%FS)	
Protection range			

Model		IT8918A-1200-720	
Overpower protection	≈18.1KW		
Overcurrent protection	≈75.6A	≈756A	
Overvoltage protection	≈1250V		
Overtemperature protection	≈85°C		
Specification			
Short circuit	Current (CC)	≈75.6A	≈756A
	Voltage (CV)	0V	0V
	Resistance (CR)	≈17mΩ	
Input terminal impedance	≈533KΩ		
Height	15U		

\*1. The voltage/current input is no less than 10%FS (FS indicates the full scope).

\*2. The scope of read-back resistance is  $(1/(1/R+(1/R)*0.01\%+0.08), 1/(1/R-(1/R)*0.01\%-0.08))$ .

\*3. The voltage/current input is no less than 10%FS.

\*4. The load current value is no less than 4% of FS\_CCH.

## 4.1.28 IT8918E-150-1800

Model		IT8918E-150-1800	
Rated value ( 040 °C)	Input voltage	0~150V	
	Input current	0~180A	0~1800A
	Input power	18KW	
	Min. operating voltage	0.2V/180A	2V/1800A
Constant voltage mode	Range	0.1~18V	0.1~150V
	Resolution	1mV	10mV
	Accuracy	±(0.05%+0.05%FS)	±(0.05%+0.05%FS)
Constant current mode	Range	0~180A	0~1800A

Model		IT8918E-150-1800	
	Resolution	10mA	100mA
	Accuracy	$\pm(0.1\%+0.1\%FS)$	$\pm(0.1\%+0.1\%FS)$
Constant resistance mode*1	Range	0.005 $\Omega$ ~10 $\Omega$	10 $\Omega$ ~7.5K $\Omega$
	Resolution	16bit	
	Accuracy	0.01%+0.08S *2	0.01%+0.0008S
Constant power Mode*3	Range	18KW	
	Resolution	1W	
	Accuracy	0.2%+0.3%FS	
Dynamic Mode			
Dynamic Mode*4	CC Mode		
	Ascending/descending slope	0.01~2.16A/uS	0.1~21.6A/uS
Measuring range			
Read-back voltage	Range	0~18V	0~150V
	Resolution	1mV	10mV
	Accuracy	$\pm(0.025\%+0.025\%FS)$	$\pm(0.025\%+0.025\%FS)$
Read-back current	Range	0~180A	0~1800A
	Resolution	10mA	100mA
	Accuracy	$\pm(0.1\%+0.1\%FS)$	$\pm(0.1\%+0.1\%FS)$
Read-back power*2	Range	18KW	
	Resolution	1W	
	Accuracy	$\pm(0.2\%+0.3\%FS)$	
Protection range			
Overpower protection	$\approx 18.1KW$		
Overcurrent protection	$\approx 189A$	$\approx 1890A$	
Overvoltage protection	$\approx 157V$		
Overtemperature protection	$\approx 85^{\circ}C$		
Specification			
Short circuit	Current (CC)	$\approx 189A$	$\approx 1890A$
	Voltage (CV)	$\approx 0V$	$\approx 0V$

Model		IT8918E-150-1800	
	Resistance (CR)	≈1.1mΩ	
Input terminal impedance		≈260KΩ	
Height		15U	

\*1. The voltage/current input is no less than 10%FS (FS indicates the full scope).

\*2. The scope of read-back resistance is  $(1/(1/R+(1/R)*0.01\%+0.08), 1/(1/R-(1/R)*0.01\%-0.08))$ .

\*3. The voltage/current input is no less than 10%FS.

\*4. The load current value is no less than 4% of FS\_CCH.

## 4.1.29 IT8918E-600-1260

Model		IT8918E-600-1260	
Rated value ( 040 °C)	Input voltage	0~600V	
	Input current	0~126A	0~1260A
	Input power	18KW	
	Min. operating voltage	0.5V/126A	5V/1260A
Constant voltage mode	Range	0.1~60V	0.1~600V
	Resolution	1mV	10mV
	Accuracy	±(0.05%+0.05%FS)	±(0.05%+0.05%FS)
Constant current mode	Range	0~126A	0~1260A
	Resolution	10mA	100mA
	Accuracy	±(0.1%+0.1%FS)	±(0.1%+0.1%FS)
Constant resistance mode*1	Range	0.005Ω~10Ω	10Ω~7.5KΩ
	Resolution	16bit	
	Accuracy	0.01%+0.08S *2	0.01%+0.0008S
Constant power Mode*3	Range	18KW	
	Resolution	1W	
	Accuracy	0.2%+0.3%FS	
Dynamic Mode			
Dynamic Mode*4	CC Mode		

Model		IT8918E-600-1260	
	Ascending/descending slope	0.01~1.44A/uS	0.1~14.4 A/uS
Measuring range			
Read-back voltage	Range	0~60V	0~600V
	Resolution	1mV	10mV
	Accuracy	$\pm(0.025\%+0.025\%FS)$	$\pm(0.025\%+0.025\%FS)$
Read-back current	Range	0~126A	0~1260A
	Resolution	10mA	100mA
	Accuracy	$\pm(0.1\%+0.1\%FS)$	$\pm(0.1\%+0.1\%FS)$
Read-back power*2	Range	18KW	
	Resolution	1W	
	Accuracy	$\pm(0.2\%+0.3\%FS)$	
Protection range			
Overpower protection	$\approx 18.1KW$		
Overcurrent protection	$\approx 132A$	$\approx 1320A$	
Overvoltage protection	$\approx 630V$		
Overtemperature protection	$\approx 85^{\circ}C$		
Specification			
Short circuit	Current (CC)	$\approx 132A$	$\approx 1320A$
	Voltage (CV)	$\approx 0V$	$\approx 0V$
	Resistance (CR)	$\approx 4m\Omega$	
Input terminal impedance	$\approx 330K\Omega$		
Height	15U		

\*1. The voltage/current input is no less than 10%FS (FS indicates the full scope).

\*2. The scope of read-back resistance is  $(1/(1/R+(1/R)*0.01\%+0.08), 1/(1/R-(1/R)*0.01\%-0.08))$ .

\*3. The voltage/current input is no less than 10%FS.

\*4. The load current value is no less than 4% of FS\_CCH.

### 4.1.30 IT8918E-1200-720

Model		IT8918E-1200-720	
Rated value ( 040 °C)	Input voltage	0~1200V	
	Input current	0~72A	0~720A
	Input power	18KW	
	Min. operating voltage	1.2V/72A	12V/720A
Constant voltage mode	Range	0.1~120V	0.1~1200V
	Resolution	10mV	100mV
	Accuracy	±(0.05%+0.05%FS)	±(0.05%+0.05%FS)
Constant current mode	Range	0~72A	0~720A
	Resolution	1mA	10mA
	Accuracy	±(0.1%+0.1%FS)	±(0.1%+0.1%FS)
Constant resistance mode*1	Range	0.02Ω~10Ω	10Ω~7.5KΩ
	Resolution	16bit	
	Accuracy	0.01%+0.08S *2	0.01%+0.0008S
Constant power Mode*3	Range	18KW	
	Resolution	1W	
	Accuracy	0.2%+0.3%FS	
Dynamic Mode			
Dynamic Mode*4	CC Mode		
	Ascending/de-scending slope	0.001~0.75A/uS	0.01~7.5 A/uS
Measuring range			
Read-back voltage	Range	0~120V	0~1200V
	Resolution	10mV	100mV
	Accuracy	±(0.025%+0.025%FS)	±(0.025%+0.025%FS)
Read-back current	Range	0~72A	0~720A
	Resolution	1mA	10mA
	Accuracy	±(0.1%+0.1%FS)	±(0.1%+0.1%FS)
Read-back power*2	Range	18KW	
	Resolution	1W	
	Accuracy	±(0.2%+0.3%FS)	
Protection range			

Model		IT8918E-1200-720	
Overpower protection	≈18.1KW		
Overcurrent protection	≈75.6A	≈756A	
Overvoltage protection	≈1250V		
Overtemperature protection	≈85°C		
Specification			
Short circuit	Current (CC)	≈75.6A	≈756A
	Voltage (CV)	0V	0V
	Resistance (CR)	≈16.7mΩ	
Input terminal impedance	≈530KΩ		
Height	15U		

\*1. The voltage/current input is no less than 10%FS (FS indicates the full scope).

\*2. The scope of read-back resistance is  $(1/(1/R+(1/R)*0.01\%+0.08), 1/(1/R-(1/R)*0.01\%-0.08))$ .

\*3. The voltage/current input is no less than 10%FS.

\*4. The load current value is no less than 4% of FS\_CCH.

### 4.1.31 IT8924A-150-2400

Model		IT8924A-150-2400	
Rated value (040 °C)	Input voltage	0~150V	
	Input current	0~240A	0~2400A
	Input power	24KW	
	Min. operating voltage	0.22V/240A	2.2V/2400A
Constant voltage mode	Range	0.1~18V	0.1~150V
	Resolution	1mV	10mV
	Accuracy	±(0.05%+0.05%FS)	±(0.05%+0.05%FS)
Constant current mode	Range	0~240A	0~2400A

Model		IT8924A-150-2400	
	Resolution	10mA	100mA
	Accuracy	$\pm(0.05\%+0.1\%FS)$	$\pm(0.05\%+0.1\%FS)$
Constant resistance mode*1	Range	0.005 $\Omega$ ~10 $\Omega$	10 $\Omega$ ~7.5K $\Omega$
	Resolution	16bit	
	Accuracy	0.01%+0.08S *2	0.01%+0.0008S
Constant power Mode*3	Range	24KW	
	Resolution	1W	
	Accuracy	0.2%+0.2%FS	
Dynamic Mode			
Dynamic Mode*4	CC Mode		
	Ascending/descending slope	0.01~4.8A/uS	0.1~48A/uS
Measuring range			
Read-back voltage	Range	0~18V	0~150V
	Resolution	1mV	10mV
	Accuracy	$\pm(0.025\%+0.025\%FS)$	$\pm(0.025\%+0.025\%FS)$
Read-back current	Range	0~240A	0~2400A
	Resolution	10mA	100mA
	Accuracy	$\pm(0.05\%+0.1\%FS)$	$\pm(0.05\%+0.1\%FS)$
Read-back power*2	Range	24KW	
	Resolution	1W	
	Accuracy	$\pm(0.2\%+0.2\%FS)$	
Protection range			
Overpower protection	$\approx 24.2KW$		
Overcurrent protection	$\approx 252A$	$\approx 2520A$	
Overvoltage protection	$\approx 157V$		
Overtemperature protection	$\approx 85^{\circ}C$		
Specification			
Short circuit	Current (CC)	$\approx 252A$	$\approx 2520A$
	Voltage (CV)	$\approx 0V$	$\approx 0V$



Model		IT8924A-150-2400
	Resistance (CR)	$\approx 0.92\text{m}\Omega$
Input terminal impedance		$\approx 200\text{K}\Omega$
Height		27U

\*1. The voltage/current input is no less than 10%FS (FS indicates the full scope).

\*2. The scope of read-back resistance is  $(1/(1/R+(1/R)*0.01\%+0.08), 1/(1/R-(1/R)*0.01\%-0.08))$ .

\*3. The voltage/current input is no less than 10%FS.

\*4. The load current value is no less than 4% of FS\_CCH.

## 4.1.32 IT8924A-600-1680

Model		IT8924A-600-1680	
Rated value ( 040 °C)	Input voltage	0~600V	
	Input current	0~168A	0~1680A
	Input power	24KW	
	Min. operating voltage	0.51V/168A	5.1V/1680A
Constant voltage mode	Range	0.1~60V	0.1~600V
	Resolution	1mV	10mV
	Accuracy	$\pm(0.05\%+0.05\%FS)$	$\pm(0.05\%+0.05\%FS)$
Constant current mode	Range	0~168A	0~1680A
	Resolution	10mA	100mA
	Accuracy	$\pm(0.05\%+0.1\%FS)$	$\pm(0.05\%+0.1\%FS)$
Constant resistance mode*1	Range	0.005 $\Omega$ ~10 $\Omega$	10 $\Omega$ ~7.5K $\Omega$
	Resolution	16bit	
	Accuracy	0.01%+0.08S *2	0.01%+0.0008S
Constant power Mode*3	Range	24KW	
	Resolution	1W	
	Accuracy	0.2%+0.2%FS	
Dynamic Mode			
Dynamic Mode*4	CC Mode		

Model		IT8924A-600-1680	
	Ascending/descending slope	0.01~2.4A/uS	0.1~24 A/uS
Measuring range			
Read-back voltage	Range	0~60V	0~600V
	Resolution	1mV	10mV
	Accuracy	$\pm(0.025\%+0.025\%FS)$	$\pm(0.025\%+0.025\%FS)$
Read-back current	Range	0~168A	0~1680A
	Resolution	10mA	100mA
	Accuracy	$\pm(0.05\%+0.1\%FS)$	$\pm(0.05\%+0.1\%FS)$
Read-back power*2	Range	24KW	
	Resolution	1W	
	Accuracy	$\pm(0.2\%+0.2\%FS)$	
Protection range			
Overpower protection	$\approx 24.2KW$		
Overcurrent protection	$\approx 176A$	$\approx 1760A$	
Overvoltage protection	$\approx 630V$		
Overtemperature protection	$\approx 85^{\circ}C$		
Specification			
Short circuit	Current (CC)	$\approx 176A$	$\approx 1760A$
	Voltage (CV)	$\approx 0V$	$\approx 0V$
	Resistance (CR)	$\approx 3m\Omega$	
Input terminal impedance	$\approx 250K\Omega$		
Height	27U		

\*1.The voltage/current input is no less than 10%FS (FS indicates the full scope).

\*2.The scope of read-back resistance is  $(1/(1/R+(1/R)*0.01\%+0.08), 1/(1/R-(1/R)*0.01\%-0.08))$ .

\*3.The voltage/current input is no less than 10%FS.

\*4.The load current value is no less than 4% of FS\_CCH.

### 4.1.33 IT8924A-1200-960

Model		IT8924A-1200-960	
Rated value ( 040 °C)	Input voltage	0~1200V	
	Input current	0~96A	0~960A
	Input power	24KW	
	Min. operating voltage	1.2V/96A	12V/960A
Constant voltage mode	Range	0.1~120V	0.1~1200V
	Resolution	10mV	100mV
	Accuracy	±(0.05%+0.05%FS)	±(0.05%+0.05%FS)
Constant current mode	Range	0~96A	0~960A
	Resolution	1mA	10mA
	Accuracy	±(0.05%+0.1%FS)	±(0.05%+0.1%FS)
Constant resistance mode*1	Range	0.02Ω~10Ω	10Ω~7.5KΩ
	Resolution	16bit	
	Accuracy	0.01%+0.08S *2	0.01%+0.0008S
Constant power Mode*3	Range	24KW	
	Resolution	1W	
	Accuracy	0.2%+0.2%FS	
Dynamic Mode			
Dynamic Mode*4	CC Mode		
	Ascending/descending slope	0.001~1.2A/uS	0.01~12 A/uS
Measuring range			
Read-back voltage	Range	0~120V	0~1200V
	Resolution	10mV	100mV
	Accuracy	±(0.025%+0.025%FS)	±(0.025%+0.025%FS)
Read-back current	Range	0~96A	0~960A
	Resolution	1mA	10mA
	Accuracy	±(0.05%+0.1%FS)	±(0.05%+0.1%FS)
Read-back power*2	Range	24KW	
	Resolution	1W	
	Accuracy	±(0.2%+0.2%FS)	
Protection range			

Model		IT8924A-1200-960	
Overpower protection	≈24.2KW		
Overcurrent protection	≈100A	≈1000A	
Overvoltage protection	≈1250V		
Overtemperature protection	≈85°C		
Specification			
Short circuit	Current (CC)	≈100A	≈1000A
	Voltage (CV)	0V	0V
	Resistance (CR)	≈12.5mΩ	
Input terminal impedance	≈400KΩ		
Height	27U		

\*1. The voltage/current input is no less than 10%FS (FS indicates the full scope).

\*2. The scope of read-back resistance is  $(1/(1/R+(1/R)*0.01\%+0.08), 1/(1/R-(1/R)*0.01\%-0.08))$ .

\*3. The voltage/current input is no less than 10%FS.

\*4. The load current value is no less than 4% of FS\_CCH.

### 4.1.34 IT8924E-150-2400

Model		IT8924E-150-2400	
Rated value ( 040 °C)	Input voltage	0~150V	
	Input current	0~240A	0~2400A
	Input power	24KW	
	Min. operating voltage	0.22V/240A	2.2V/2400A
Constant voltage mode	Range	0.1~18V	0.1~150V
	Resolution	1mV	10mV
	Accuracy	±(0.05%+0.05%FS)	±(0.05%+0.05%FS)
Constant current mode	Range	0~240A	0~2400A

Model		IT8924E-150-2400	
	Resolution	10mA	100mA
	Accuracy	$\pm(0.1\%+0.1\%FS)$	$\pm(0.1\%+0.1\%FS)$
Constant resistance mode*1	Range	0.005 $\Omega$ ~10 $\Omega$	10 $\Omega$ ~7.5K $\Omega$
	Resolution	16bit	
	Accuracy	0.01%+0.08S *2	0.01%+0.0008S
Constant power Mode*3	Range	24KW	
	Resolution	1W	
	Accuracy	0.2%+0.3%FS	
Dynamic Mode			
Dynamic Mode*4	CC Mode		
	Ascending/descending slope	0.01~2.88A/uS	0.1~28.8A/uS
Measuring range			
Read-back voltage	Range	0~18V	0~150V
	Resolution	1mV	10mV
	Accuracy	$\pm(0.025\%+0.025\%FS)$	$\pm(0.025\%+0.025\%FS)$
Read-back current	Range	0~240A	0~2400A
	Resolution	10mA	100mA
	Accuracy	$\pm(0.1\%+0.1\%FS)$	$\pm(0.1\%+0.1\%FS)$
Read-back power*2	Range	24KW	
	Resolution	1W	
	Accuracy	$\pm(0.2\%+0.3\%FS)$	
Protection range			
Overpower protection	$\approx 24.2KW$		
Overcurrent protection	$\approx 252A$	$\approx 2520A$	
Overvoltage protection	$\approx 157V$		
Overtemperature protection	$\approx 85^{\circ}C$		
Specification			
Short circuit	Current (CC)	$\approx 252A$	$\approx 2520A$
	Voltage (CV)	$\approx 0V$	$\approx 0V$

Model		IT8924E-150-2400
	Resistance (CR)	$\approx 0.92\text{m}\Omega$
Input terminal impedance		$\approx 200\text{K}\Omega$
Height		27U

\*1. The voltage/current input is no less than 10%FS (FS indicates the full scope).

\*2. The scope of read-back resistance is  $(1/(1/R+(1/R)*0.01\%+0.08), 1/(1/R-(1/R)*0.01\%-0.08))$ .

\*3. The voltage/current input is no less than 10%FS.

\*4. The load current value is no less than 4% of FS\_CCH.

### 4.1.35 IT8924E-600-1680

Model		IT8924E-600-1680	
Rated value ( 040 °C)	Input voltage	0~600V	
	Input current	0~168A	0~1680A
	Input power	24KW	
	Min. operating voltage	0.51V/168A	5.1V/1680A
Constant voltage mode	Range	0.1~60V	0.1~600V
	Resolution	1mV	10mV
	Accuracy	$\pm(0.05\%+0.05\%\text{FS})$	$\pm(0.05\%+0.05\%\text{FS})$
Constant current mode	Range	0~168A	0~1680A
	Resolution	10mA	100mA
	Accuracy	$\pm(0.1\%+0.1\%\text{FS})$	$\pm(0.1\%+0.1\%\text{FS})$
Constant resistance mode*1	Range	0.005 $\Omega$ ~10 $\Omega$	10 $\Omega$ ~7.5K $\Omega$
	Resolution	16bit	
	Accuracy	0.01%+0.08S *2	0.01%+0.0008S
Constant power Mode*3	Range	24KW	
	Resolution	1W	
	Accuracy	0.2%+0.3%FS	
Dynamic Mode			
Dynamic Mode*4	CC Mode		

Model		IT8924E-600-1680	
	Ascending/descending slope	0.01~1.92A/uS	0.1~19.2 A/uS
Measuring range			
Read-back voltage	Range	0~60V	0~600V
	Resolution	1mV	10mV
	Accuracy	$\pm(0.025\%+0.025\%FS)$	$\pm(0.025\%+0.025\%FS)$
Read-back current	Range	0~168A	0~1680A
	Resolution	10mA	100mA
	Accuracy	$\pm(0.1\%+0.1\%FS)$	$\pm(0.1\%+0.1\%FS)$
Read-back power*2	Range	24KW	
	Resolution	1W	
	Accuracy	$\pm(0.2\%+0.3\%FS)$	
Protection range			
Overpower protection	$\approx 24.2KW$		
Overcurrent protection	$\approx 176A$	$\approx 1760A$	
Overvoltage protection	$\approx 630V$		
Overtemperature protection	$\approx 85^{\circ}C$		
Specification			
Short circuit	Current (CC)	$\approx 176A$	$\approx 1760A$
	Voltage (CV)	$\approx 0V$	$\approx 0V$
	Resistance (CR)	$\approx 3m\Omega$	
Input terminal impedance	$\approx 250K\Omega$		
Height	27U		

\*1. The voltage/current input is no less than 10%FS (FS indicates the full scope).

\*2. The scope of read-back resistance is  $(1/(1/R+(1/R)*0.01\%+0.08), 1/(1/R-(1/R)*0.01\%-0.08))$ .

\*3. The voltage/current input is no less than 10%FS.

\*4. The load current value is no less than 4% of FS\_CCH.

### 4.1.36 IT8924E-1200-960

Model		IT8924E-1200-960	
Rated value ( 040 °C)	Input voltage	0~1200V	
	Input current	0~96A	0~960A
	Input power	24KW	
	Min. operating voltage	1.2V/96A	12V/960A
Constant voltage mode	Range	0.1~120V	0.1~1200V
	Resolution	10mV	100mV
	Accuracy	±(0.05%+0.05%FS)	±(0.05%+0.05%FS)
Constant current mode	Range	0~96A	0~960A
	Resolution	1mA	10mA
	Accuracy	±(0.1%+0.1%FS)	±(0.1%+0.1%FS)
Constant resistance mode*1	Range	0.02Ω~10Ω	10Ω~7.5KΩ
	Resolution	16bit	
	Accuracy	0.01%+0.08S *2	0.01%+0.0008S
Constant power Mode*3	Range	24KW	
	Resolution	1W	
	Accuracy	0.2%+0.3%FS	
Dynamic Mode			
Dynamic Mode*4	CC Mode		
	Ascending/descending slope	0.01~1A/uS	0.1~10 A/uS
Measuring range			
Read-back voltage	Range	0~120V	0~1200V
	Resolution	10mV	100mV
	Accuracy	±(0.025%+0.025%FS)	±(0.025%+0.025%FS)
Read-back current	Range	0~96A	0~960A
	Resolution	1mA	10mA
	Accuracy	±(0.1%+0.1%FS)	±(0.1%+0.1%FS)
Read-back power*2	Range	24KW	
	Resolution	1W	
	Accuracy	±(0.2%+0.3%FS)	
Protection range			



Model		IT8924E-1200-960	
Overpower protection	≈24.2KW		
Overcurrent protection	≈100A	≈1000A	
Overvoltage protection	≈1250V		
Overtemperature protection	≈85°C		
Specification			
Short circuit	Current (CC)	≈100A	≈1000A
	Voltage (CV)	0V	0V
	Resistance (CR)	≈12.5mΩ	
Input terminal impedance	≈400KΩ		
Height	27U		

\*1. The voltage/current input is no less than 10%FS (FS indicates the full scope).

\*2. The scope of read-back resistance is  $(1/(1/R+(1/R)*0.01\%+0.08), 1/(1/R-(1/R)*0.01\%-0.08))$ .

\*3. The voltage/current input is no less than 10%FS.

\*4. The load current value is no less than 4% of FS\_CCH.

### 4.1.37 IT8930A-150-2400

Model		IT8930A-150-2400	
Rated value ( 040 °C)	Input voltage	0~150V	
	Input current	0~240A	0~2400A
	Input power	30KW	
	Min. operating voltage	0.2V/240A	2V/2400A
Constant voltage mode	Range	0.1~18V	0.1~150V
	Resolution	1mV	10mV
	Accuracy	±(0.05%+0.05%FS)	±(0.05%+0.05%FS)
Constant current mode	Range	0~240A	0~2400A

Model		IT8930A-150-2400	
	Resolution	10mA	100mA
	Accuracy	$\pm(0.1\%+0.1\%FS)$	$\pm(0.1\%+0.1\%FS)$
Constant resistance mode*1	Range	0.005 $\Omega$ ~10 $\Omega$	10 $\Omega$ ~7.5K $\Omega$
	Resolution	16bit	
	Accuracy	0.01%+0.08S *2	0.01%+0.0008S
Constant power Mode*3	Range	30KW	
	Resolution	1W	
	Accuracy	0.2%+0.3%FS	
Dynamic Mode			
Dynamic Mode*4	CC Mode		
	Ascending/descending slope	0.01~4.8A/uS	0.1~48A/uS
Measuring range			
Read-back voltage	Range	0~18V	0~150V
	Resolution	1mV	10mV
	Accuracy	$\pm(0.025\%+0.025\%FS)$	$\pm(0.025\%+0.025\%FS)$
Read-back current	Range	0~240A	0~2400A
	Resolution	10mA	100mA
	Accuracy	$\pm(0.1\%+0.1\%FS)$	$\pm(0.1\%+0.1\%FS)$
Read-back power*2	Range	30KW	
	Resolution	1W	
	Accuracy	$\pm(0.2\%+0.3\%FS)$	
Protection range			
Overpower protection	$\approx 30.3KW$		
Overcurrent protection	$\approx 252A$	$\approx 2520A$	
Overvoltage protection	$\approx 157V$		
Overtemperature protection	$\approx 85^{\circ}C$		
Specification			
Short circuit	Current (CC)	$\approx 252A$	$\approx 2520A$
	Voltage (CV)	$\approx 0V$	$\approx 0V$

Model		IT8930A-150-2400
	Resistance (CR)	$\approx 0.8m\Omega$
Input terminal impedance		$\approx 160K\Omega$
Height		27U

\*1. The voltage/current input is no less than 10%FS (FS indicates the full scope).

\*2. The scope of read-back resistance is  $(1/(1/R+(1/R)*0.01\%+0.08), 1/(1/R-(1/R)*0.01\%-0.08))$ .

\*3. The voltage/current input is no less than 10%FS.

\*4. The load current value is no less than 4% of FS\_CCH.

### 4.1.38 IT8930A-600-2100

Model		IT8930A-600-2100	
Rated value ( 040 °C)	Input voltage	0~600V	
	Input current	0~210A	0~2100A
	Input power	30KW	
	Min. operating voltage	0.52V/210A	5.2V/2100A
Constant voltage mode	Range	0.1~60V	0.1~600V
	Resolution	1mV	10mV
	Accuracy	$\pm(0.05\%+0.05\%FS)$	$\pm(0.05\%+0.05\%FS)$
Constant current mode	Range	0~210A	0~2100A
	Resolution	10mA	100mA
	Accuracy	$\pm(0.05\%+0.1\%FS)$	$\pm(0.05\%+0.1\%FS)$
Constant resistance mode*1	Range	0.005 $\Omega$ ~10 $\Omega$	10 $\Omega$ ~7.5K $\Omega$
	Resolution	16bit	
	Accuracy	0.01%+0.08S *2	0.01%+0.0008S
Constant power Mode*3	Range	30KW	
	Resolution	1W	
	Accuracy	0.2%+0.2%FS	
Dynamic Mode			
Dynamic Mode*4	CC Mode		

Model		IT8930A-600-2100	
	Ascending/descending slope	0.01~3A/uS	0.1~30 A/uS
Measuring range			
Read-back voltage	Range	0~60V	0~600V
	Resolution	1mV	10mV
	Accuracy	$\pm(0.025\%+0.025\%FS)$	$\pm(0.025\%+0.025\%FS)$
Read-back current	Range	0~210A	0~2100A
	Resolution	10mA	100mA
	Accuracy	$\pm(0.05\%+0.1\%FS)$	$\pm(0.05\%+0.1\%FS)$
Read-back power*2	Range	30KW	
	Resolution	1W	
	Accuracy	$\pm(0.2\%+0.2\%FS)$	
Protection range			
Overpower protection	$\approx 30.3KW$		
Overcurrent protection	$\approx 220A$	$\approx 2200A$	
Overvoltage protection	$\approx 630V$		
Overtemperature protection	$\approx 85^{\circ}C$		
Specification			
Short circuit	Current (CC)	$\approx 220A$	$\approx 2200A$
	Voltage (CV)	$\approx 0V$	$\approx 0V$
	Resistance (CR)	$\approx 2.5m\Omega$	
Input terminal impedance	$\approx 200K\Omega$		
Height	27U		

\*1. The voltage/current input is no less than 10%FS (FS indicates the full scope).

\*2. The scope of read-back resistance is  $(1/(1/R+(1/R)*0.01\%+0.08), 1/(1/R-(1/R)*0.01\%-0.08))$ .

\*3. The voltage/current input is no less than 10%FS.

\*4. The load current value is no less than 4% of FS\_CCH.

### 4.1.39 IT8930A-1200-1200

Model		IT8930A-1200-1200	
Rated value ( 040 °C)	Input voltage	0~1200V	
	Input current	0~120A	0~1200A
	Input power	30KW	
	Min. operating voltage	1.2V/120A	12V/1200A
Constant voltage mode	Range	0.1~120V	0.1~1200V
	Resolution	10mV	100mV
	Accuracy	±(0.05%+0.05%FS)	±(0.05%+0.05%FS)
Constant current mode	Range	0~120A	0~1200A
	Resolution	10mA	100mA
	Accuracy	±(0.05%+0.1%FS)	±(0.05%+0.1%FS)
Constant resistance mode*1	Range	0.01Ω~10Ω	10Ω~7.5KΩ
	Resolution	16bit	
	Accuracy	0.01%+0.08S *2	0.01%+0.0008S
Constant power Mode*3	Range	30KW	
	Resolution	1W	
	Accuracy	0.2%+0.2%FS	
Dynamic Mode			
Dynamic Mode*4	CC Mode		
	Ascending/de-scending slope	0.01~1.5A/uS	0.1~15 A/uS
Measuring range			
Read-back voltage	Range	0~120V	0~1200V
	Resolution	10mV	100mV
	Accuracy	±(0.025%+0.025%FS)	±(0.025%+0.025%FS)
Read-back current	Range	0~120A	0~1200A
	Resolution	10mA	100mA
	Accuracy	±(0.05%+0.1%FS)	±(0.05%+0.1%FS)
Read-back power*2	Range	30KW	
	Resolution	1W	
	Accuracy	±(0.2%+0.2%FS)	
Protection range			

Model		IT8930A-1200-1200	
Overpower protection	≈30.3KW		
Overcurrent protection	≈126A	≈1260A	
Overvoltage protection	≈1250V		
Overtemperature protection	≈85°C		
Specification			
Short circuit	Current (CC)	≈126A	≈1260A
	Voltage (CV)	0V	0V
	Resistance (CR)	≈10mΩ	
Input terminal impedance	≈320KΩ		
Height	27U		

\*1. The voltage/current input is no less than 10%FS (FS indicates the full scope).

\*2. The scope of read-back resistance is  $(1/(1/R+(1/R)*0.01\%+0.08), 1/(1/R-(1/R)*0.01\%-0.08))$ .

\*3. The voltage/current input is no less than 10%FS.

\*4. The load current value is no less than 4% of FS\_CCH.

#### 4.1.40 IT8930E-150-2400

Model		IT8930E-150-2400	
Rated value ( 040 °C)	Input voltage	0~150V	
	Input current	0~240A	0~2400A
	Input power	30KW	
	Min. operating voltage	0.2V/240A	2V/2400A
Constant voltage mode	Range	0.1~18V	0.1~150V
	Resolution	1mV	10mV
	Accuracy	±(0.05%+0.05%FS)	±(0.05%+0.05%FS)
Constant current mode	Range	0~240A	0~2400A

Model		IT8930E-150-2400	
	Resolution	10mA	100mA
	Accuracy	$\pm(0.1\%+0.15\%FS)$	$\pm(0.1\%+0.15\%FS)$
Constant resistance mode*1	Range	0.005 $\Omega$ ~10 $\Omega$	10 $\Omega$ ~7.5K $\Omega$
	Resolution	16bit	
	Accuracy	0.01%+0.08S *2	0.01%+0.0008S
Constant power Mode*3	Range	30KW	
	Resolution	1W	
	Accuracy	0.25%+0.3%FS	
Dynamic Mode			
Dynamic Mode*4	CC Mode		
	Ascending/descending slope	0.01~2.88A/uS	0.1~28.8A/uS
Measuring range			
Read-back voltage	Range	0~18V	0~150V
	Resolution	1mV	10mV
	Accuracy	$\pm(0.025\%+0.025\%FS)$	$\pm(0.025\%+0.025\%FS)$
Read-back current	Range	0~240A	0~2400A
	Resolution	10mA	100mA
	Accuracy	$\pm(0.1\%+0.15\%FS)$	$\pm(0.1\%+0.15\%FS)$
Read-back power*2	Range	30KW	
	Resolution	1W	
	Accuracy	$\pm(0.25\%+0.3\%FS)$	
Protection range			
Overpower protection	$\approx 30.3KW$		
Overcurrent protection	$\approx 252A$	$\approx 2520A$	
Overvoltage protection	$\approx 157V$		
Overtemperature protection	$\approx 85^{\circ}C$		
Specification			
Short circuit	Current (CC)	$\approx 252A$	$\approx 2520A$
	Voltage (CV)	$\approx 0V$	$\approx 0V$

Model		IT8930E-150-2400
	Resistance (CR)	$\approx 0.8m\Omega$
Input terminal impedance		$\approx 160K\Omega$
Height		27U

\*1. The voltage/current input is no less than 10%FS (FS indicates the full scope).

\*2. The scope of read-back resistance is  $(1/(1/R+(1/R)*0.01\%+0.08), 1/(1/R-(1/R)*0.01\%-0.08))$ .

\*3. The voltage/current input is no less than 10%FS.

\*4. The load current value is no less than 4% of FS\_CCH.

#### 4.1.41 IT8930E-600-2100

Model		IT8930E-600-2100	
Rated value ( 040 °C)	Input voltage	0~600V	
	Input current	0~210A	0~2100A
	Input power	30KW	
	Min. operating voltage	0.52V/210A	5.2V/2100A
Constant voltage mode	Range	0.1~60V	0.1~600V
	Resolution	1mV	10mV
	Accuracy	$\pm(0.05\%+0.05\%FS)$	$\pm(0.05\%+0.05\%FS)$
Constant current mode	Range	0~210A	0~2100A
	Resolution	10mA	100mA
	Accuracy	$\pm(0.1\%+0.1\%FS)$	$\pm(0.1\%+0.1\%FS)$
Constant resistance mode*1	Range	0.005 $\Omega$ ~10 $\Omega$	10 $\Omega$ ~7.5K $\Omega$
	Resolution	16bit	
	Accuracy	0.01%+0.08S *2	0.01%+0.0008S
Constant power Mode*3	Range	30KW	
	Resolution	1W	
	Accuracy	0.2%+0.3%FS	
Dynamic Mode			
Dynamic Mode*4	CC Mode		



Model		IT8930E-600-2100	
	Ascending/descending slope	0.01~2.4A/uS	0.1~24 A/uS
Measuring range			
Read-back voltage	Range	0~60V	0~600V
	Resolution	1mV	10mV
	Accuracy	$\pm(0.025\%+0.025\%FS)$	$\pm(0.025\%+0.025\%FS)$
Read-back current	Range	0~210A	0~2100A
	Resolution	10mA	100mA
	Accuracy	$\pm(0.1\%+0.1\%FS)$	$\pm(0.1\%+0.1\%FS)$
Read-back power*2	Range	30KW	
	Resolution	1W	
	Accuracy	$\pm(0.2\%+0.3\%FS)$	
Protection range			
Overpower protection	$\approx 30.3KW$		
Overcurrent protection	$\approx 220A$	$\approx 2200A$	
Overvoltage protection	$\approx 630V$		
Overtemperature protection	$\approx 85^{\circ}C$		
Specification			
Short circuit	Current (CC)	$\approx 220A$	$\approx 2200A$
	Voltage (CV)	$\approx 0V$	$\approx 0V$
	Resistance (CR)	$\approx 2.5m\Omega$	
Input terminal impedance	$\approx 200K\Omega$		
Height	27U		

\*1. The voltage/current input is no less than 10%FS (FS indicates the full scope).

\*2. The scope of read-back resistance is  $(1/(1/R+(1/R)*0.01\%+0.08), 1/(1/R-(1/R)*0.01\%-0.08))$ .

\*3. The voltage/current input is no less than 10%FS.

\*4. The load current value is no less than 4% of FS\_CCH.

## 4.1.42 IT8930E-1200-1200

Model		IT8930E-1200-1200	
Rated value ( 040 °C)	Input voltage	0~1200V	
	Input current	0~120A	0~1200A
	Input power	30KW	
	Min. operating voltage	1.2V/120A	12V/1200A
Constant voltage mode	Range	0.1~120V	0.1~1200V
	Resolution	10mV	100mV
	Accuracy	$\pm(0.05\%+0.05\%FS)$	$\pm(0.05\%+0.05\%FS)$
Constant current mode	Range	0~120A	0~1200A
	Resolution	10mA	100mA
	Accuracy	$\pm(0.1\%+0.1\%FS)$	$\pm(0.1\%+0.1\%FS)$
Constant resistance mode*1	Range	0.01 $\Omega$ ~10 $\Omega$	10 $\Omega$ ~7.5K $\Omega$
	Resolution	16bit	
	Accuracy	0.01%+0.08S *2	0.01%+0.0008S
Constant power Mode*3	Range	30KW	
	Resolution	1W	
	Accuracy	0.2%+0.3%FS	
Dynamic Mode			
Dynamic Mode*4	CC Mode		
	Ascending/descending slope	0.01~1.25A/uS	0.1~12.5 A/uS
Measuring range			
Read-back voltage	Range	0~120V	0~1200V
	Resolution	10mV	100mV
	Accuracy	$\pm(0.025\%+0.025\%FS)$	$\pm(0.025\%+0.025\%FS)$
Read-back current	Range	0~120A	0~1200A
	Resolution	10mA	100mA
	Accuracy	$\pm(0.1\%+0.1\%FS)$	$\pm(0.1\%+0.1\%FS)$
Read-back power*2	Range	30KW	
	Resolution	1W	
	Accuracy	$\pm(0.2\%+0.3\%FS)$	
Protection range			

Model		IT8930E-1200-1200	
Overpower protection	≈30.3KW		
Overcurrent protection	≈126A	≈1260A	
Overvoltage protection	≈1250V		
Overtemperature protection	≈85°C		
Specification			
Short circuit	Current (CC)	≈126A	≈1260A
	Voltage (CV)	≈0V	≈0V
	Resistance (CR)	≈10mΩ	
Input terminal impedance	≈320KΩ		
Height	27U		

\*1. The voltage/current input is no less than 10%FS (FS indicates the full scope).

\*2. The scope of read-back resistance is  $(1/(1/R+(1/R)*0.01\%+0.08), 1/(1/R-(1/R)*0.01\%-0.08))$ .

\*3. The voltage/current input is no less than 10%FS.

\*4. The load current value is no less than 4% of FS\_CCH.

#### 4.1.43 IT8936A-150-2400

Model		IT8936A-150-2400	
Rated value ( 040 °C)	Input voltage	0~150V	
	Input current	0~240A	0~2400A
	Input power	36KW	
	Min. operating voltage	0.17V/240A	1.7V/2400A
Constant voltage mode	Range	0.1~18V	0.1~150V
	Resolution	1mV	10mV
	Accuracy	±(0.05%+0.05%FS)	±(0.05%+0.05%FS)
Constant current mode	Range	0~240A	0~2400A

Model		IT8936A-150-2400	
	Resolution	10mA	100mA
	Accuracy	$\pm(0.1\%+0.1\%FS)$	$\pm(0.1\%+0.1\%FS)$
Constant resistance mode*1	Range	0.005 $\Omega$ ~10 $\Omega$	10 $\Omega$ ~7.5K $\Omega$
	Resolution	16bit	
	Accuracy	0.01%+0.08S *2	0.01%+0.0008S
Constant power Mode*3	Range	36KW	
	Resolution	1W	
	Accuracy	0.2%+0.3%FS	
Dynamic Mode			
Dynamic Mode*4	CC Mode		
	Ascending/descending slope	0.01~4.8A/uS	0.1~48A/uS
Measuring range			
Read-back voltage	Range	0~18V	0~150V
	Resolution	1mV	10mV
	Accuracy	$\pm(0.025\%+0.025\%FS)$	$\pm(0.025\%+0.025\%FS)$
Read-back current	Range	0~240A	0~2400A
	Resolution	10mA	100mA
	Accuracy	$\pm(0.1\%+0.1\%FS)$	$\pm(0.1\%+0.1\%FS)$
Read-back power*2	Range	36KW	
	Resolution	1W	
	Accuracy	$\pm(0.2\%+0.3\%FS)$	
Protection range			
Overpower protection	$\approx 36.3KW$		
Overcurrent protection	$\approx 252A$	$\approx 2520A$	
Overvoltage protection	$\approx 157V$		
Overtemperature protection	$\approx 85^{\circ}C$		
Specification			
Short circuit	Current (CC)	$\approx 252A$	$\approx 2520A$
	Voltage (CV)	$\approx 0V$	$\approx 0V$

Model		IT8936A-150-2400
	Resistance (CR)	$\approx 0.7m\Omega$
Input terminal impedance		$\approx 133K\Omega$
Height		27U

\*1. The voltage/current input is no less than 10%FS (FS indicates the full scope).

\*2. The scope of read-back resistance is  $(1/(1/R+(1/R)*0.01\%+0.08), 1/(1/R-(1/R)*0.01\%-0.08))$ .

\*3. The voltage/current input is no less than 10%FS.

\*4. The load current value is no less than 4% of FS\_CCH.

#### 4.1.44 IT8936A-600-2400

Model		IT8936A-600-2400	
Rated value ( 040 °C)	Input voltage	0~600V	
	Input current	0~240A	0~2400A
	Input power	36KW	
	Min. operating voltage	0.55V/240A	5.5V/2400A
Constant voltage mode	Range	0.1~60V	0.1~600V
	Resolution	1mV	10mV
	Accuracy	$\pm(0.05\%+0.05\%FS)$	$\pm(0.05\%+0.05\%FS)$
Constant current mode	Range	0~240A	0~2400A
	Resolution	10mA	100mA
	Accuracy	$\pm(0.05\%+0.15\%FS)$	$\pm(0.05\%+0.15\%FS)$
Constant resistance mode*1	Range	0.005 $\Omega$ ~10 $\Omega$	10 $\Omega$ ~7.5K $\Omega$
	Resolution	16bit	
	Accuracy	0.01%+0.08S *2	0.01%+0.0008S
Constant power Mode*3	Range	36KW	
	Resolution	1W	
	Accuracy	0.2%+0.2%FS	
Dynamic Mode			
Dynamic Mode*4	CC Mode		

Model		IT8936A-600-2400	
	Ascending/descending slope	0.01~3.6A/uS	0.1~36 A/uS
Measuring range			
Read-back voltage	Range	0~60V	0~600V
	Resolution	1mV	10mV
	Accuracy	$\pm(0.025\%+0.025\%FS)$	$\pm(0.025\%+0.025\%FS)$
Read-back current	Range	0~240A	0~2400A
	Resolution	10mA	100mA
	Accuracy	$\pm(0.05\%+0.15\%FS)$	$\pm(0.05\%+0.15\%FS)$
Read-back power*2	Range	36KW	
	Resolution	1W	
	Accuracy	$\pm(0.2\%+0.2\%FS)$	
Protection range			
Overpower protection	$\approx 36.3KW$		
Overcurrent protection	$\approx 252A$	$\approx 2520A$	
Overvoltage protection	$\approx 630V$		
Overtemperature protection	$\approx 85^{\circ}C$		
Specification			
Short circuit	Current (CC)	$\approx 252A$	$\approx 2520A$
	Voltage (CV)	$\approx 0V$	$\approx 0V$
	Resistance (CR)	$\approx 2.3m\Omega$	
Input terminal impedance	$\approx 167K\Omega$		
Height	27U		

\*1. The voltage/current input is no less than 10%FS (FS indicates the full scope).

\*2. The scope of read-back resistance is  $(1/(1/R+(1/R)*0.01\%+0.08), 1/(1/R-(1/R)*0.01\%-0.08))$ .

\*3. The voltage/current input is no less than 10%FS.

\*4. The load current value is no less than 4% of FS\_CCH.

## 4.1.45 IT8936A-1200-1440

Model		IT8936A-1200-1440	
Rated value ( 040 °C)	Input voltage	0~1200V	
	Input current	0~144A	0~1440A
	Input power	36KW	
	Min. operating voltage	1.2V/144A	12V/1440A
Constant voltage mode	Range	0.1~120V	0.1~1200V
	Resolution	10mV	100mV
	Accuracy	±(0.05%+0.05%FS)	±(0.05%+0.05%FS)
Constant current mode	Range	0~144A	0~1440A
	Resolution	10mA	100mA
	Accuracy	±(0.05%+0.1%FS)	±(0.05%+0.1%FS)
Constant resistance mode*1	Range	0.01Ω~10Ω	10Ω~7.5KΩ
	Resolution	16bit	
	Accuracy	0.01%+0.08S *2	0.01%+0.0008S
Constant power Mode*3	Range	36KW	
	Resolution	1W	
	Accuracy	0.2%+0.2%FS	
Dynamic Mode			
Dynamic Mode*4	CC Mode		
	Ascending/descending slope	0.01~1.8A/uS	0.1~18 A/uS
Measuring range			
Read-back voltage	Range	0~120V	0~1200V
	Resolution	10mV	100mV
	Accuracy	±(0.025%+0.025%FS)	±(0.025%+0.025%FS)
Read-back current	Range	0~144A	0~1440A
	Resolution	10mA	100mA
	Accuracy	±(0.05%+0.1%FS)	±(0.05%+0.1%FS)
Read-back power*2	Range	36KW	
	Resolution	1W	
	Accuracy	±(0.2%+0.2%FS)	
Protection range			

Model		IT8936A-1200-1440	
Overpower protection	≈36.3KW		
Overcurrent protection	≈151A	≈1510A	
Overvoltage protection	≈1250V		
Overtemperature protection	≈85°C		
Specification			
Short circuit	Current (CC)	≈151A	≈1510A
	Voltage (CV)	0V	0V
	Resistance (CR)	≈8.3mΩ	
Input terminal impedance	≈267KΩ		
Height	27U		

\*1. The voltage/current input is no less than 10%FS (FS indicates the full scope).

\*2. The scope of read-back resistance is  $(1/(1/R+(1/R)*0.01\%+0.08), 1/(1/R-(1/R)*0.01\%-0.08))$ .

\*3. The voltage/current input is no less than 10%FS.

\*4. The load current value is no less than 4% of FS\_CCH.

#### 4.1.46 IT8936E-150-2400

Model		IT8936E-150-2400	
Rated value ( 040 °C)	Input voltage	0~150V	
	Input current	0~240A	0~2400A
	Input power	36KW	
	Min. operating voltage	0.17V/240A	1.7V/2400A
Constant voltage mode	Range	0.1~18V	0.1~150V
	Resolution	1mV	10mV
	Accuracy	±(0.05%+0.05%FS)	±(0.05%+0.05%FS)
Constant current mode	Range	0~240A	0~2400A



Model		IT8936E-150-2400	
	Resolution	10mA	100mA
	Accuracy	$\pm(0.15\%+0.15\%FS)$	$\pm(0.15\%+0.15\%FS)$
Constant resistance mode*1	Range	0.005 $\Omega$ ~10 $\Omega$	10 $\Omega$ ~7.5K $\Omega$
	Resolution	16bit	
	Accuracy	0.01%+0.08S *2	0.01%+0.0008S
Constant power Mode*3	Range	36KW	
	Resolution	1W	
	Accuracy	0.3%+0.3%FS	
Dynamic Mode			
Dynamic Mode*4	CC Mode		
	Ascending/descending slope	0.01~2.88A/uS	0.1~28.8A/uS
Measuring range			
Read-back voltage	Range	0~18V	0~150V
	Resolution	1mV	10mV
	Accuracy	$\pm(0.025\%+0.025\%FS)$	$\pm(0.025\%+0.025\%FS)$
Read-back current	Range	0~240A	0~2400A
	Resolution	10mA	100mA
	Accuracy	$\pm(0.15\%+0.15\%FS)$	$\pm(0.15\%+0.15\%FS)$
Read-back power*2	Range	36KW	
	Resolution	1W	
	Accuracy	$\pm(0.3\%+0.3\%FS)$	
Protection range			
Overpower protection	$\approx 36.3KW$		
Overcurrent protection	$\approx 252A$	$\approx 2520A$	
Overvoltage protection	$\approx 157V$		
Overtemperature protection	$\approx 85^{\circ}C$		
Specification			
Short circuit	Current (CC)	$\approx 252A$	$\approx 2520A$
	Voltage (CV)	$\approx 0V$	$\approx 0V$

Model		IT8936E-150-2400
	Resistance (CR)	$\approx 0.7m\Omega$
Input terminal impedance		$\approx 133K\Omega$
Height		27U

\*1. The voltage/current input is no less than 10%FS (FS indicates the full scope).

\*2. The scope of read-back resistance is  $(1/(1/R+(1/R)*0.01\%+0.08), 1/(1/R-(1/R)*0.01\%-0.08))$ .

\*3. The voltage/current input is no less than 10%FS.

\*4. The load current value is no less than 4% of FS\_CCH.

#### 4.1.47 IT8936E-600-2400

Model		IT8936E-600-2400	
Rated value ( 040 °C)	Input voltage	0~600V	
	Input current	0~240A	0~2400A
	Input power	36KW	
	Min. operating voltage	0.55V/240A	5.5V/2400A
Constant voltage mode	Range	0.1~60V	0.1~600V
	Resolution	1mV	10mV
	Accuracy	$\pm(0.05\%+0.05\%FS)$	$\pm(0.05\%+0.05\%FS)$
Constant current mode	Range	0~240A	0~2400A
	Resolution	10mA	100mA
	Accuracy	$\pm(0.1\%+0.15\%FS)$	$\pm(0.1\%+0.15\%FS)$
Constant resistance mode*1	Range	0.005 $\Omega$ ~10 $\Omega$	10 $\Omega$ ~7.5K $\Omega$
	Resolution	16bit	
	Accuracy	0.01%+0.08S *2	0.01%+0.0008S
Constant power Mode*3	Range	36KW	
	Resolution	1W	
	Accuracy	0.2%+0.3%FS	
Dynamic Mode			
Dynamic Mode*4	CC Mode		

Model		IT8936E-600-2400	
	Ascending/de-scending slope	0.01~2.88A/uS	0.1~28.8 A/uS
Measuring range			
Read-back voltage	Range	0~60V	0~600V
	Resolution	1mV	10mV
	Accuracy	$\pm(0.025\%+0.025\%FS)$	$\pm(0.025\%+0.025\%FS)$
Read-back current	Range	0~240A	0~2400A
	Resolution	10mA	100mA
	Accuracy	$\pm(0.1\%+0.15\%FS)$	$\pm(0.1\%+0.15\%FS)$
Read-back power*2	Range	36KW	
	Resolution	1W	
	Accuracy	$\pm(0.2\%+0.3\%FS)$	
Protection range			
Overpower protection	$\approx 36.3KW$		
Overcurrent protection	$\approx 252A$	$\approx 2520A$	
Overvoltage protection	$\approx 630V$		
Overtemperature protection	$\approx 85^{\circ}C$		
Specification			
Short circuit	Current (CC)	$\approx 252A$	$\approx 2520A$
	Voltage (CV)	$\approx 0V$	$\approx 0V$
	Resistance (CR)	$\approx 2.3m\Omega$	
Input terminal impedance	$\approx 167K\Omega$		
Height	27U		

\*1. The voltage/current input is no less than 10%FS (FS indicates the full scope).

\*2. The scope of read-back resistance is  $(1/(1/R+(1/R)*0.01\%+0.08), 1/(1/R-(1/R)*0.01\%-0.08))$ .

\*3. The voltage/current input is no less than 10%FS.

\*4. The load current value is no less than 4% of FS\_CCH.

**4.1.48 IT8936E-1200-1440**

Model		IT8936E-1200-1440	
Rated value ( 040 °C)	Input voltage	0~1200V	
	Input current	0~144A	0~1440A
	Input power	36KW	
	Min. operating voltage	1.2V/144A	12V/1440A
Constant voltage mode	Range	0.1~120V	0.1~1200V
	Resolution	10mV	100mV
	Accuracy	±(0.05%+0.05%FS)	±(0.05%+0.05%FS)
Constant current mode	Range	0~144A	0~1440A
	Resolution	10mA	100mA
	Accuracy	±(0.1%+0.1%FS)	±(0.1%+0.1%FS)
Constant resistance mode*1	Range	0.01Ω~10Ω	10Ω~7.5KΩ
	Resolution	16bit	
	Accuracy	0.01%+0.08S *2	0.01%+0.0008S
Constant power Mode*3	Range	36KW	
	Resolution	1W	
	Accuracy	0.2%+0.3%FS	
Dynamic Mode			
Dynamic Mode*4	CC Mode		
	Ascending/descending slope	0.01~1.5A/uS	0.1~15 A/uS
Measuring range			
Read-back voltage	Range	0~120V	0~1200V
	Resolution	10mV	100mV
	Accuracy	±(0.025%+0.025%FS)	±(0.025%+0.025%FS)
Read-back current	Range	0~144A	0~1440A
	Resolution	10mA	100mA
	Accuracy	±(0.1%+0.1%FS)	±(0.1%+0.1%FS)
Read-back power*2	Range	36KW	
	Resolution	1W	
	Accuracy	±(0.2%+0.3%FS)	
Protection range			

Model		IT8936E-1200-1440	
Overpower protection	≈36.3KW		
Overcurrent protection	≈151A	≈1510A	
Overvoltage protection	≈1250V		
Overtemperature protection	≈85°C		
Specification			
Short circuit	Current (CC)	≈151A	≈1510A
	Voltage (CV)	≈0V	≈0V
	Resistance (CR)	≈8.3mΩ	
Input terminal impedance	≈267KΩ		
Height	27U		

\*1. The voltage/current input is no less than 10%FS (FS indicates the full scope).

\*2. The scope of read-back resistance is  $(1/(1/R+(1/R)*0.01\%+0.08), 1/(1/R-(1/R)*0.01\%-0.08))$ .

\*3. The voltage/current input is no less than 10%FS.

\*4. The load current value is no less than 4% of FS\_CCH.

#### 4.1.49 IT8942A-150-2400

Model		IT8942A-150-2400	
Rated value ( 040 °C)	Input voltage	0~150V	
	Input current	0~240A	0~2400A
	Input power	42KW	
	Min. operating voltage	0.152V/240A	1.52V/2400A
Constant voltage mode	Range	0.1~18V	0.1~150V
	Resolution	1mV	10mV
	Accuracy	±(0.05%+0.05%FS)	±(0.05%+0.05%FS)
Constant current mode	Range	0~240A	0~2400A

Model		IT8942A-150-2400	
	Resolution	10mA	100mA
	Accuracy	$\pm(0.1\%+0.15\%FS)$	$\pm(0.1\%+0.15\%FS)$
Constant resistance mode*1	Range	0.005 $\Omega$ ~10 $\Omega$	10 $\Omega$ ~7.5K $\Omega$
	Resolution	16bit	
	Accuracy	0.01%+0.08S *2	0.01%+0.0008S
Constant power Mode*3	Range	42KW	
	Resolution	1W	
	Accuracy	0.25%+0.3%FS	
Dynamic Mode			
Dynamic Mode*4	CC Mode		
	Ascending/descending slope	0.01~4.8A/uS	0.1~48A/uS
Measuring range			
Read-back voltage	Range	0~18V	0~150V
	Resolution	1mV	10mV
	Accuracy	$\pm(0.025\%+0.025\%FS)$	$\pm(0.025\%+0.025\%FS)$
Read-back current	Range	0~240A	0~2400A
	Resolution	10mA	100mA
	Accuracy	$\pm(0.1\%+0.15\%FS)$	$\pm(0.1\%+0.15\%FS)$
Read-back power*2	Range	42KW	
	Resolution	1W	
	Accuracy	$\pm(0.25\%+0.3\%FS)$	
Protection range			
Overpower protection	$\approx 42.4KW$		
Overcurrent protection	$\approx 252A$	$\approx 2520A$	
Overvoltage protection	$\approx 157V$		
Overtemperature protection	$\approx 85^{\circ}C$		
Specification			
Short circuit	Current (CC)	$\approx 252A$	$\approx 2520A$
	Voltage (CV)	$\approx 0V$	$\approx 0V$

Model		IT8942A-150-2400
	Resistance (CR)	$\approx 0.63\text{m}\Omega$
Input terminal impedance		$\approx 114\text{K}\Omega$
Height		37U

\*1. The voltage/current input is no less than 10%FS (FS indicates the full scope).

\*2. The scope of read-back resistance is  $(1/(1/R+(1/R)*0.01\%+0.08), 1/(1/R-(1/R)*0.01\%-0.08))$ .

\*3. The voltage/current input is no less than 10%FS.

\*4. The load current value is no less than 4% of FS\_CCH.

### 4.1.50 IT8942A-600-2400

Model		IT8942A-600-2400	
Rated value ( 040 °C)	Input voltage	0~600V	
	Input current	0~240A	0~2400A
	Input power	42KW	
	Min. operating voltage	0.53V/240A	5.3V/2400A
Constant voltage mode	Range	0.1~60V	0.1~600V
	Resolution	1mV	10mV
	Accuracy	$\pm(0.05\%+0.05\%\text{FS})$	$\pm(0.05\%+0.05\%\text{FS})$
Constant current mode	Range	0~240A	0~2400A
	Resolution	10mA	100mA
	Accuracy	$\pm(0.05\%+0.15\%\text{FS})$	$\pm(0.05\%+0.15\%\text{FS})$
Constant resistance mode*1	Range	0.005 $\Omega$ ~10 $\Omega$	10 $\Omega$ ~7.5K $\Omega$
	Resolution	16bit	
	Accuracy	0.01%+0.08S *2	0.01%+0.0008S
Constant power Mode*3	Range	42KW	
	Resolution	1W	
	Accuracy	0.2%+0.3%FS	
Dynamic Mode			
Dynamic Mode*4	CC Mode		

Model		IT8942A-600-2400	
	Ascending/de- scending slope	0.01~3.6A/uS	0.1~36 A/uS
Measuring range			
Read-back voltage	Range	0~60V	0~600V
	Resolution	1mV	10mV
	Accuracy	$\pm(0.025\%+0.025\%FS)$	$\pm(0.025\%+0.025\%FS)$
Read-back current	Range	0~240A	0~2400A
	Resolution	10mA	100mA
	Accuracy	$\pm(0.05\%+0.15\%FS)$	$\pm(0.05\%+0.15\%FS)$
Read-back power*2	Range	42KW	
	Resolution	1W	
	Accuracy	$\pm(0.2\%+0.3\%FS)$	
Protection range			
Overpower protection	$\approx 42.4KW$		
Overcurrent protection	$\approx 252A$	$\approx 2520A$	
Overvoltage protection	$\approx 630V$		
Overtemperature protection	$\approx 85^{\circ}C$		
Specification			
Short circuit	Current (CC)	$\approx 252A$	$\approx 2520A$
	Voltage (CV)	$\approx 0V$	$\approx 0V$
	Resistance (CR)	$\approx 2.2m\Omega$	
Input terminal impedance	$\approx 142K\Omega$		
Height	37U		

\*1. The voltage/current input is no less than 10%FS (FS indicates the full scope).

\*2. The scope of read-back resistance is  $(1/(1/R+(1/R)*0.01\%+0.08), 1/(1/R-(1/R)*0.01\%-0.08))$ .

\*3. The voltage/current input is no less than 10%FS.

\*4. The load current value is no less than 4% of FS\_CCH.



### 4.1.51 IT8942A-1200-1680

Model		IT8942A-1200-1680	
Rated value ( 040 °C)	Input voltage	0~1200V	
	Input current	0~168A	0~1680A
	Input power	42KW	
	Min. operating voltage	1.2V/168A	12V/1680A
Constant voltage mode	Range	0.1~120V	0.1~1200V
	Resolution	10mV	100mV
	Accuracy	±(0.05%+0.05%FS)	±(0.05%+0.05%FS)
Constant current mode	Range	0~168A	0~1680A
	Resolution	10mA	100mA
	Accuracy	±(0.05%+0.1%FS)	±(0.05%+0.1%FS)
Constant resistance mode*1	Range	0.01Ω~10Ω	10Ω~7.5KΩ
	Resolution	16bit	
	Accuracy	0.01%+0.08S *2	0.01%+0.0008S
Constant power Mode*3	Range	42KW	
	Resolution	1W	
	Accuracy	0.2%+0.2%FS	
Dynamic Mode			
Dynamic Mode*4	CC Mode		
	Ascending/descending slope	0.01~2.1A/uS	0.1~21 A/uS
Measuring range			
Read-back voltage	Range	0~120V	0~1200V
	Resolution	10mV	100mV
	Accuracy	±(0.025%+0.025%FS)	±(0.025%+0.025%FS)
Read-back current	Range	0~168A	0~1680A
	Resolution	10mA	100mA
	Accuracy	±(0.05%+0.1%FS)	±(0.05%+0.1%FS)
Read-back power*2	Range	42KW	
	Resolution	1W	
	Accuracy	±(0.2%+0.2%FS)	
Protection range			

Model		IT8942A-1200-1680	
Overpower protection	≈42.4KW		
Overcurrent protection	≈176A	≈1760A	
Overvoltage protection	≈1250V		
Overtemperature protection	≈85°C		
Specification			
Short circuit	Current (CC)	≈176A	≈1760A
	Voltage (CV)	0V	0V
	Resistance (CR)	≈7.1mΩ	
Input terminal impedance	≈228KΩ		
Height	37U		

\*1. The voltage/current input is no less than 10%FS (FS indicates the full scope).

\*2. The scope of read-back resistance is  $(1/(1/R+(1/R)*0.01\%+0.08), 1/(1/R-(1/R)*0.01\%-0.08))$ .

\*3. The voltage/current input is no less than 10%FS.

\*4. The load current value is no less than 4% of FS\_CCH.

## 4.1.52 IT8942E-150-2400

Model		IT8942E-150-2400	
Rated value ( 040 °C)	Input voltage	0~150V	
	Input current	0~240A	0~2400A
	Input power	42KW	
	Min. operating voltage	0.152V/240A	1.52V/2400A
Constant voltage mode	Range	0.1~18V	0.1~150V
	Resolution	1mV	10mV
	Accuracy	±(0.05%+0.05%FS)	±(0.05%+0.05%FS)
Constant current mode	Range	0~240A	0~2400A

Model		IT8942E-150-2400	
	Resolution	10mA	100mA
	Accuracy	$\pm(0.15\%+0.2\%FS)$	$\pm(0.15\%+0.2\%FS)$
Constant resistance mode*1	Range	0.005 $\Omega$ ~10 $\Omega$	10 $\Omega$ ~7.5K $\Omega$
	Resolution	16bit	
	Accuracy	0.01%+0.08S *2	0.01%+0.0008S
Constant power Mode*3	Range	42KW	
	Resolution	1W	
	Accuracy	0.3%+0.35%FS	
Dynamic Mode			
Dynamic Mode*4	CC Mode		
	Ascending/descending slope	0.01~2.88A/uS	0.1~28.8A/uS
Measuring range			
Read-back voltage	Range	0~18V	0~150V
	Resolution	1mV	10mV
	Accuracy	$\pm(0.025\%+0.025\%FS)$	$\pm(0.025\%+0.025\%FS)$
Read-back current	Range	0~240A	0~2400A
	Resolution	10mA	100mA
	Accuracy	$\pm(0.15\%+0.2\%FS)$	$\pm(0.15\%+0.2\%FS)$
Read-back power*2	Range	42KW	
	Resolution	1W	
	Accuracy	$\pm(0.3\%+0.35\%FS)$	
Protection range			
Overpower protection	$\approx 42.4KW$		
Overcurrent protection	$\approx 252A$	$\approx 2520A$	
Overvoltage protection	$\approx 157V$		
Overtemperature protection	$\approx 85^{\circ}C$		
Specification			
Short circuit	Current (CC)	$\approx 252A$	$\approx 2520A$
	Voltage (CV)	$\approx 0V$	$\approx 0V$

Model		IT8942E-150-2400
	Resistance (CR)	$\approx 0.63\text{m}\Omega$
Input terminal impedance		$\approx 114\text{K}\Omega$
Height		37U

\*1. The voltage/current input is no less than 10%FS (FS indicates the full scope).

\*2. The scope of read-back resistance is  $(1/(1/R+(1/R)*0.01\%+0.08), 1/(1/R-(1/R)*0.01\%-0.08))$ .

\*3. The voltage/current input is no less than 10%FS.

\*4. The load current value is no less than 4% of FS\_CCH.

### 4.1.53 IT8942E-600-2400

Model		IT8942E-600-2400	
Rated value ( 040 °C)	Input voltage	0~600V	
	Input current	0~240A	0~2400A
	Input power	42KW	
	Min. operating voltage	0.53V/240A	5.3V/2400A
Constant voltage mode	Range	0.1~60V	0.1~600V
	Resolution	1mV	10mV
	Accuracy	$\pm(0.05\%+0.05\%\text{FS})$	$\pm(0.05\%+0.05\%\text{FS})$
Constant current mode	Range	0~240A	0~2400A
	Resolution	10mA	100mA
	Accuracy	$\pm(0.1\%+0.15\%\text{FS})$	$\pm(0.1\%+0.15\%\text{FS})$
Constant resistance mode*1	Range	0.005 $\Omega$ ~10 $\Omega$	10 $\Omega$ ~7.5K $\Omega$
	Resolution	16bit	
	Accuracy	0.01%+0.08S *2	0.01%+0.0008S
Constant power Mode*3	Range	42KW	
	Resolution	1W	
	Accuracy	0.2%+0.3%FS	
Dynamic Mode			
Dynamic Mode*4	CC Mode		

Model		IT8942E-600-2400	
	Ascending/de- scending slope	0.01~2.88A/uS	0.1~28.8 A/uS
Measuring range			
Read-back voltage	Range	0~60V	0~600V
	Resolution	1mV	10mV
	Accuracy	$\pm(0.025\%+0.025\%FS)$	$\pm(0.025\%+0.025\%FS)$
Read-back current	Range	0~240A	0~2400A
	Resolution	10mA	100mA
	Accuracy	$\pm(0.1\%+0.15\%FS)$	$\pm(0.1\%+0.15\%FS)$
Read-back power*2	Range	42KW	
	Resolution	1W	
	Accuracy	$\pm(0.2\%+0.3\%FS)$	
Protection range			
Overpower protection	$\approx 42.4KW$		
Overcurrent protection	$\approx 252A$	$\approx 2520A$	
Overvoltage protection	$\approx 630V$		
Overtemperature protection	$\approx 85^{\circ}C$		
Specification			
Short circuit	Current (CC)	$\approx 252A$	$\approx 2520A$
	Voltage (CV)	$\approx 0V$	$\approx 0V$
	Resistance (CR)	$\approx 2.2m\Omega$	
Input terminal impedance	$\approx 142K\Omega$		
Height	37U		

\*1. The voltage/current input is no less than 10%FS (FS indicates the full scope).

\*2. The scope of read-back resistance is  $(1/(1/R+(1/R)*0.01\%+0.08), 1/(1/R-(1/R)*0.01\%-0.08))$ .

\*3. The voltage/current input is no less than 10%FS.

\*4. The load current value is no less than 4% of FS\_CCH.

### 4.1.54 IT8942E-1200-1680

Model		IT8942E-1200-1680	
Rated value ( 040 °C)	Input voltage	0~1200V	
	Input current	0~168A	0~1680A
	Input power	42KW	
	Min. operating voltage	1.2V/168A	12V/1680A
Constant voltage mode	Range	0.1~120V	0.1~1200V
	Resolution	10mV	100mV
	Accuracy	±(0.05%+0.05%FS)	±(0.05%+0.05%FS)
Constant current mode	Range	0~168A	0~1680A
	Resolution	10mA	100mA
	Accuracy	±(0.1%+0.1%FS)	±(0.1%+0.1%FS)
Constant resistance mode*1	Range	0.01Ω~10Ω	10Ω~7.5KΩ
	Resolution	16bit	
	Accuracy	0.01%+0.08S *2	0.01%+0.0008S
Constant power Mode*3	Range	42KW	
	Resolution	1W	
	Accuracy	0.2%+0.3%FS	
Dynamic Mode			
Dynamic Mode*4	CC Mode		
	Ascending/descending slope	0.01~1.75A/uS	0.1~17.5 A/uS
Measuring range			
Read-back voltage	Range	0~120V	0~1200V
	Resolution	10mV	100mV
	Accuracy	±(0.025%+0.025%FS)	±(0.025%+0.025%FS)
Read-back current	Range	0~168A	0~1680A
	Resolution	10mA	100mA
	Accuracy	±(0.1%+0.1%FS)	±(0.1%+0.1%FS)
Read-back power*2	Range	42KW	
	Resolution	1W	
	Accuracy	±(0.2%+0.3%FS)	
Protection range			

Model		IT8942E-1200-1680	
Overpower protection	≈42.4KW		
Overcurrent protection	≈176A	≈1760A	
Overvoltage protection	≈1250V		
Overtemperature protection	≈85°C		
Specification			
Short circuit	Current (CC)	≈176A	≈1760A
	Voltage (CV)	≈0V	≈0V
	Resistance (CR)	≈7.1mΩ	
Input terminal impedance	≈228KΩ		
Height	37U		

\*1.The voltage/current input is no less than 10%FS (FS indicates the full scope).

\*2.The scope of read-back resistance is  $(1/(1/R+(1/R)*0.01\%+0.08), 1/(1/R-(1/R)*0.01\%-0.08))$ .

\*3.The voltage/current input is no less than 10%FS.

\*4.The load current value is no less than 4% of FS\_CCH.

### 4.1.55 IT8948A-150-2400

Model		IT8948A-150-2400	
Rated value ( 040 °C)	Input voltage	0~150V	
	Input current	0~240A	0~2400A
	Input power	48KW	
	Min. operating voltage	0.14V/240A	1.4V/2400A
Constant voltage mode	Range	0.1~18V	0.1~150V
	Resolution	1mV	10mV
	Accuracy	±(0.05%+0.05%FS)	±(0.05%+0.05%FS)
Constant current mode	Range	0~240A	0~2400A
	Resolution	10mA	100mA

Model		IT8948A-150-2400	
	Accuracy	$\pm(0.1\%+0.2\%FS)$	$\pm(0.1\%+0.2\%FS)$
Constant resistance mode*1	Range	0.005 $\Omega$ ~10 $\Omega$	10 $\Omega$ ~7.5K $\Omega$
	Resolution	16bit	
	Accuracy	0.01%+0.08S *2	0.01%+0.0008S
Constant power Mode*3	Range	48KW	
	Resolution	1W	
	Accuracy	0.3%+0.3%FS	
Dynamic Mode			
Dynamic Mode*4	CC Mode		
	Ascending/descending slope	0.01~4.8A/uS	0.1~48A/uS
Measuring range			
Read-back voltage	Range	0~18V	0~150V
	Resolution	1mV	10mV
	Accuracy	$\pm(0.025\%+0.025\%FS)$	$\pm(0.025\%+0.025\%FS)$
Read-back current	Range	0~240A	0~2400A
	Resolution	10mA	100mA
	Accuracy	$\pm(0.1\%+0.2\%FS)$	$\pm(0.1\%+0.2\%FS)$
Read-back power*2	Range	48KW	
	Resolution	1W	
	Accuracy	$\pm(0.3\%+0.3\%FS)$	
Protection range			
Overpower protection	$\approx 48.4KW$		
Overcurrent protection	$\approx 252A$	$\approx 2520A$	
Overvoltage protection	$\approx 157V$		
Overtemperature protection	$\approx 85^{\circ}C$		
Specification			
Short circuit	Current (CC)	$\approx 252A$	$\approx 2520A$
	Voltage (CV)	$\approx 0V$	$\approx 0V$
	Resistance (CR)	$\approx 0.58m\Omega$	



Model	IT8948A-150-2400
Input terminal impedance	$\approx 100\text{K}\Omega$
Height	37U

\*1. The voltage/current input is no less than 10%FS (FS indicates the full scope).

\*2. The scope of read-back resistance is  $(1/(1/R+(1/R)*0.01\%+0.08), 1/(1/R-(1/R)*0.01\%-0.08))$ .

\*3. The voltage/current input is no less than 10%FS.

\*4. The load current value is no less than 4% of FS\_CCH.

### 4.1.56 IT8948A-600-2400

Model	IT8948A-600-2400	
Rated value ( 040 °C)	Input voltage	0~600V
	Input current	0~240A      0~2400A
	Input power	48KW
	Min. operating voltage	0.5V/240A      5V/2400A
Constant voltage mode	Range	0.1~60V      0.1~600V
	Resolution	1mV      10mV
	Accuracy	$\pm(0.05\%+0.05\%FS)$ $\pm(0.05\%+0.05\%FS)$
Constant current mode	Range	0~240A      0~2400A
	Resolution	10mA      100mA
	Accuracy	$\pm(0.05\%+0.15\%FS)$ $\pm(0.05\%+0.15\%FS)$
Constant resistance mode*1	Range	0.005 $\Omega$ ~10 $\Omega$ 10 $\Omega$ ~7.5K $\Omega$
	Resolution	16bit
	Accuracy	0.01%+0.08S *2      0.01%+0.0008S
Constant power Mode*3	Range	48KW
	Resolution	1W
	Accuracy	0.2%+0.3%FS
Dynamic Mode		
Dynamic Mode*4	CC Mode	

Model		IT8948A-600-2400	
	Ascending/de-scending slope	0.01~3.6A/uS	0.1~36A/uS
Measuring range			
Read-back voltage	Range	0~60V	0~600V
	Resolution	1mV	10mV
	Accuracy	$\pm(0.025\%+0.025\%FS)$	$\pm(0.025\%+0.025\%FS)$
Read-back current	Range	0~240A	0~2400A
	Resolution	10mA	100mA
	Accuracy	$\pm(0.05\%+0.15\%FS)$	$\pm(0.05\%+0.15\%FS)$
Read-back power*2	Range	48KW	
	Resolution	1W	
	Accuracy	$\pm(0.2\%+0.3\%FS)$	
Protection range			
Overpower protection	$\approx 48.4KW$		
Overcurrent protection	$\approx 252A$	$\approx 2520A$	
Overvoltage protection	$\approx 630V$		
Overtemperature protection	$\approx 85^{\circ}C$		
Specification			
Short circuit	Current (CC)	$\approx 252A$	$\approx 2520A$
	Voltage (CV)	$\approx 0V$	$\approx 0V$
	Resistance (CR)	$\approx 2.1m\Omega$	
Input terminal impedance	$\approx 125K\Omega$		
Height	37U		

\*1. The voltage/current input is no less than 10%FS (FS indicates the full scope).

\*2. The scope of read-back resistance is  $(1/(1/R+(1/R)*0.01\%+0.08), 1/(1/R-(1/R)*0.01\%-0.08))$ .

\*3. The voltage/current input is no less than 10%FS.

\*4. The load current value is no less than 4% of FS\_CCH.

## 4.1.57 IT8948A-1200-1920

Model		IT8948A-1200-1920	
Rated value ( 040 °C)	Input voltage	0~1200V	
	Input current	0~192A	0~1920A
	Input power	48KW	
	Min. operating voltage	1.2V/192A	12V/1920A
Constant voltage mode	Range	0.1~120V	0.1~1200V
	Resolution	10mV	100mV
	Accuracy	±(0.05%+0.05%FS)	±(0.05%+0.05%FS)
Constant current mode	Range	0~192A	0~1920A
	Resolution	10mA	100mA
	Accuracy	±(0.05%+0.1%FS)	±(0.05%+0.1%FS)
Constant resistance mode*1	Range	0.01Ω~10Ω	10Ω~7.5KΩ
	Resolution	16bit	
	Accuracy	0.01%+0.08S *2	0.01%+0.0008S
Constant power Mode*3	Range	48KW	
	Resolution	1W	
	Accuracy	0.2%+0.2%FS	
Dynamic Mode			
Dynamic Mode*4	CC Mode		
	Ascending/descending slope	0.01~2.4A/uS	0.1~24 A/uS
Measuring range			
Read-back voltage	Range	0~120V	0~1200V
	Resolution	10mV	100mV
	Accuracy	±(0.025%+0.025%FS)	±(0.025%+0.025%FS)
Read-back current	Range	0~192A	0~1920A
	Resolution	10mA	100mA
	Accuracy	±(0.05%+0.1%FS)	±(0.05%+0.1%FS)
Read-back power*2	Range	48KW	
	Resolution	1W	
	Accuracy	±(0.2%+0.2%FS)	
Protection range			

Model		IT8948A-1200-1920	
Overpower protection	≈48.4KW		
Overcurrent protection	≈201A	≈2010A	
Overvoltage protection	≈1250V		
Overtemperature protection	≈85°C		
Specification			
Short circuit	Current (CC)	≈201A	≈2010A
	Voltage (CV)	0V	0V
	Resistance (CR)	≈6.2mΩ	
Input terminal impedance	≈200KΩ		
Height	37U		

\*1. The voltage/current input is no less than 10%FS (FS indicates the full scope).

\*2. The scope of read-back resistance is  $(1/(1/R+(1/R)*0.01\%+0.08), 1/(1/R-(1/R)*0.01\%-0.08))$ .

\*3. The voltage/current input is no less than 10%FS.

\*4. The load current value is no less than 4% of FS\_CCH.

## 4.1.58 IT8948E-150-2400

Model		IT8948E-150-2400	
Rated value ( 040 °C)	Input voltage	0~150V	
	Input current	0~240A	0~2400A
	Input power	48KW	
	Min. operating voltage	0.14V/240A	1.4V/2400A
Constant voltage mode	Range	0.1~18V	0.1~150V
	Resolution	1mV	10mV
	Accuracy	±(0.05%+0.05%FS)	±(0.05%+0.05%FS)
Constant current mode	Range	0~240A	0~2400A

Model		IT8948E-150-2400	
	Resolution	10mA	100mA
	Accuracy	$\pm(0.2\%+0.2\%FS)$	$\pm(0.2\%+0.2\%FS)$
Constant resistance mode*1	Range	0.005 $\Omega$ ~10 $\Omega$	10 $\Omega$ ~7.5K $\Omega$
	Resolution	16bit	
	Accuracy	0.01%+0.08S *2	0.01%+0.0008S
Constant power Mode*3	Range	48KW	
	Resolution	1W	
	Accuracy	0.35%+0.35%FS	
Dynamic Mode			
Dynamic Mode*4	CC Mode		
	Ascending/descending slope	0.01~2.88A/uS	0.1~28.8A/uS
Measuring range			
Read-back voltage	Range	0~18V	0~150V
	Resolution	1mV	10mV
	Accuracy	$\pm(0.025\%+0.025\%FS)$	$\pm(0.025\%+0.025\%FS)$
Read-back current	Range	0~240A	0~2400A
	Resolution	10mA	100mA
	Accuracy	$\pm(0.2\%+0.2\%FS)$	$\pm(0.2\%+0.2\%FS)$
Read-back power*2	Range	48KW	
	Resolution	1W	
	Accuracy	$\pm(0.35\%+0.35\%FS)$	
Protection range			
Overpower protection	$\approx 48.4KW$		
Overcurrent protection	$\approx 252A$	$\approx 2520A$	
Overvoltage protection	$\approx 157V$		
Overtemperature protection	$\approx 85^{\circ}C$		
Specification			
Short circuit	Current (CC)	$\approx 252A$	$\approx 2520A$
	Voltage (CV)	$\approx 0V$	$\approx 0V$

Model		IT8948E-150-2400
	Resistance (CR)	$\approx 0.58\text{m}\Omega$
Input terminal impedance		$\approx 100\text{K}\Omega$
Height		37U

\*1.The voltage/current input is no less than 10%FS (FS indicates the full scope).

\*2.The scope of read-back resistance is  $(1/(1/R+(1/R)*0.01\%+0.08), 1/(1/R-(1/R)*0.01\%-0.08))$ .

\*3.The voltage/current input is no less than 10%FS.

\*4.The load current value is no less than 4% of FS\_CCH.

### 4.1.59 IT8948E-600-2400

Model		IT8948E-600-2400	
Rated value ( 040 °C)	Input voltage	0~600V	
	Input current	0~240A	0~2400A
	Input power	48KW	
	Min. operating voltage	0.5V/240A	5.0V/2400A
Constant voltage mode	Range	0.1~60V	0.1~600V
	Resolution	1mV	10mV
	Accuracy	$\pm(0.05\%+0.05\%FS)$	$\pm(0.05\%+0.05\%FS)$
Constant current mode	Range	0~240A	0~2400A
	Resolution	10mA	100mA
	Accuracy	$\pm(0.1\%+0.15\%FS)$	$\pm(0.1\%+0.15\%FS)$
Constant resistance mode*1	Range	0.005 $\Omega$ ~10 $\Omega$	10 $\Omega$ ~7.5K $\Omega$
	Resolution	16bit	
	Accuracy	0.01%+0.08S *2	0.01%+0.0008S
Constant power Mode*3	Range	48KW	
	Resolution	1W	
	Accuracy	0.2%+0.3%FS	
Dynamic Mode			
Dynamic Mode*4	CC Mode		

Model		IT8948E-600-2400	
	Ascending/descending slope	0.01~2.88A/uS	0.1~28.8 A/uS
Measuring range			
Read-back voltage	Range	0~60V	0~600V
	Resolution	1mV	10mV
	Accuracy	$\pm(0.025\%+0.025\%FS)$	$\pm(0.025\%+0.025\%FS)$
Read-back current	Range	0~240A	0~2400A
	Resolution	10mA	100mA
	Accuracy	$\pm(0.1\%+0.15\%FS)$	$\pm(0.1\%+0.15\%FS)$
Read-back power*2	Range	48KW	
	Resolution	1W	
	Accuracy	$\pm(0.2\%+0.3\%FS)$	
Protection range			
Overpower protection	$\approx 48.4KW$		
Overcurrent protection	$\approx 252A$	$\approx 2520A$	
Overvoltage protection	$\approx 630V$		
Overtemperature protection	$\approx 85^{\circ}C$		
Specification			
Short circuit	Current (CC)	$\approx 252A$	$\approx 2520A$
	Voltage (CV)	$\approx 0V$	$\approx 0V$
	Resistance (CR)	$\approx 2.1m\Omega$	
Input terminal impedance	$\approx 125K\Omega$		
Height	37U		

\*1. The voltage/current input is no less than 10%FS (FS indicates the full scope).

\*2. The scope of read-back resistance is  $(1/(1/R+(1/R)*0.01\%+0.08), 1/(1/R-(1/R)*0.01\%-0.08))$ .

\*3. The voltage/current input is no less than 10%FS.

\*4. The load current value is no less than 4% of FS\_CCH.

## 4.1.60 IT8948E-1200-1920

Model		IT8948E-1200-1920	
Rated value ( 040 °C)	Input voltage	0~1200V	
	Input current	0~192A	0~1920A
	Input power	48KW	
	Min. operating voltage	1.2V/192A	12V/1920A
Constant voltage mode	Range	0.1~120V	0.1~1200V
	Resolution	10mV	100mV
	Accuracy	$\pm(0.05\%+0.05\%FS)$	$\pm(0.05\%+0.05\%FS)$
Constant current mode	Range	0~192A	0~1920A
	Resolution	10mA	100mA
	Accuracy	$\pm(0.1\%+0.1\%FS)$	$\pm(0.1\%+0.1\%FS)$
Constant resistance mode*1	Range	0.01 $\Omega$ ~10 $\Omega$	10 $\Omega$ ~7.5K $\Omega$
	Resolution	16bit	
	Accuracy	0.01%+0.08S *2	0.01%+0.0008S
Constant power Mode*3	Range	48KW	
	Resolution	1W	
	Accuracy	0.2%+0.3%FS	
Dynamic Mode			
Dynamic Mode*4	CC Mode		
	Ascending/de-scending slope	0.01~2A/uS	0.1~20 A/uS
Measuring range			
Read-back voltage	Range	0~120V	0~1200V
	Resolution	10mV	100mV
	Accuracy	$\pm(0.025\%+0.025\%FS)$	$\pm(0.025\%+0.025\%FS)$
Read-back current	Range	0~192A	0~1920A
	Resolution	10mA	100mA
	Accuracy	$\pm(0.1\%+0.1\%FS)$	$\pm(0.1\%+0.1\%FS)$
Read-back power*2	Range	48KW	
	Resolution	1W	
	Accuracy	$\pm(0.2\%+0.3\%FS)$	
Protection range			



Model		IT8948E-1200-1920	
Overpower protection	≈48.4KW		
Overcurrent protection	≈201A	≈2010A	
Overvoltage protection	≈1250V		
Overtemperature protection	≈85°C		
Specification			
Short circuit	Current (CC)	≈201A	≈2010A
	Voltage (CV)	≈0V	≈0V
	Resistance (CR)	≈6.2mΩ	
Input terminal impedance	≈200KΩ		
Height	37U		

\*1. The voltage/current input is no less than 10%FS (FS indicates the full scope).

\*2. The scope of read-back resistance is  $(1/(1/R+(1/R)*0.01\%+0.08), 1/(1/R-(1/R)*0.01\%-0.08))$ .

\*3. The voltage/current input is no less than 10%FS.

\*4. The load current value is no less than 4% of FS\_CCH.

#### 4.1.61 IT8954A-150-2400

Model		IT8954A-150-2400	
Rated value ( 040 °C)	Input voltage	0~150V	
	Input current	0~240A	0~2400A
	Input power	54KW	
	Min. operating voltage	0.13V/240A	1.3V/2400A
Constant voltage mode	Range	0.1~18V	0.1~150V
	Resolution	1mV	10mV
	Accuracy	±(0.05%+0.05%FS)	±(0.05%+0.05%FS)
Constant current mode	Range	0~240A	0~2400A

Model		IT8954A-150-2400	
	Resolution	10mA	100mA
	Accuracy	$\pm(0.15\%+0.2\%FS)$	$\pm(0.15\%+0.2\%FS)$
Constant resistance mode*1	Range	0.005 $\Omega$ ~10 $\Omega$	10 $\Omega$ ~7.5K $\Omega$
	Resolution	16bit	
	Accuracy	0.01%+0.08S *2	0.01%+0.0008S
Constant power Mode*3	Range	54KW	
	Resolution	1W	
	Accuracy	0.3%+0.35%FS	
Dynamic Mode			
Dynamic Mode*4	CC Mode		
	Ascending/descending slope	0.01~4.8A/uS	0.1~48A/uS
Measuring range			
Read-back voltage	Range	0~18V	0~150V
	Resolution	1mV	10mV
	Accuracy	$\pm(0.025\%+0.025\%FS)$	$\pm(0.025\%+0.025\%FS)$
Read-back current	Range	0~240A	0~2400A
	Resolution	10mA	100mA
	Accuracy	$\pm(0.15\%+0.2\%FS)$	$\pm(0.15\%+0.2\%FS)$
Read-back power*2	Range	54KW	
	Resolution	1W	
	Accuracy	$\pm(0.3\%+0.35\%FS)$	
Protection range			
Overpower protection	$\approx$ 54.5KW		
Overcurrent protection	$\approx$ 252A	$\approx$ 2520A	
Overvoltage protection	$\approx$ 157V		
Overtemperature protection	$\approx$ 85 $^{\circ}$ C		
Specification			
Short circuit	Current (CC)	$\approx$ 252A	$\approx$ 2520A
	Voltage (CV)	$\approx$ 0V	$\approx$ 0V

Model		IT8954A-150-2400
	Resistance (CR)	$\approx 0.54m\Omega$
Input terminal impedance		$\approx 90K\Omega$
Height		37U

\*1. The voltage/current input is no less than 10%FS (FS indicates the full scope).

\*2. The scope of read-back resistance is  $(1/(1/R+(1/R)*0.01\%+0.08), 1/(1/R-(1/R)*0.01\%-0.08))$ .

\*3. The voltage/current input is no less than 10%FS.

\*4. The load current value is no less than 4% of FS\_CCH.

## 4.1.62 IT8954A-600-2400

Model		IT8954A-600-2400	
Rated value ( 040 °C)	Input voltage	0~600V	
	Input current	0~240A	0~2400A
	Input power	54KW	
	Min. operating voltage	0.48V/240A	4.8V/2400A
Constant voltage mode	Range	0.1~60V	0.1~600V
	Resolution	1mV	10mV
	Accuracy	$\pm(0.05\%+0.05\%FS)$	$\pm(0.05\%+0.05\%FS)$
Constant current mode	Range	0~240A	0~2400A
	Resolution	10mA	100mA
	Accuracy	$\pm(0.05\%+0.15\%FS)$	$\pm(0.05\%+0.15\%FS)$
Constant resistance mode*1	Range	0.005 $\Omega$ ~10 $\Omega$	10 $\Omega$ ~7.5K $\Omega$
	Resolution	16bit	
	Accuracy	0.01%+0.08S *2	0.01%+0.0008S
Constant power Mode*3	Range	54KW	
	Resolution	1W	
	Accuracy	0.2%+0.3%FS	
Dynamic Mode			
Dynamic Mode*4	CC Mode		

Model		IT8954A-600-2400	
	Ascending/descending slope	0.01~3.6A/uS	0.1~36 A/uS
Measuring range			
Read-back voltage	Range	0~60V	0~600V
	Resolution	1mV	10mV
	Accuracy	$\pm(0.025\%+0.025\%FS)$	$\pm(0.025\%+0.025\%FS)$
Read-back current	Range	0~240A	0~2400A
	Resolution	10mA	100mA
	Accuracy	$\pm(0.05\%+0.15\%FS)$	$\pm(0.05\%+0.15\%FS)$
Read-back power*2	Range	54KW	
	Resolution	1W	
	Accuracy	$\pm(0.2\%+0.3\%FS)$	
Protection range			
Overpower protection	$\approx 54.5KW$		
Overcurrent protection	$\approx 252A$	$\approx 2520A$	
Overvoltage protection	$\approx 630V$		
Overtemperature protection	$\approx 85^{\circ}C$		
Specification			
Short circuit	Current (CC)	$\approx 252A$	$\approx 2520A$
	Voltage (CV)	$\approx 0V$	$\approx 0V$
	Resistance (CR)	$\approx 2m\Omega$	
Input terminal impedance	$\approx 110K\Omega$		
Height	37U		

\*1. The voltage/current input is no less than 10%FS (FS indicates the full scope).

\*2. The scope of read-back resistance is  $(1/(1/R+(1/R)*0.01\%+0.08), 1/(1/R-(1/R)*0.01\%-0.08))$ .

\*3. The voltage/current input is no less than 10%FS.

\*4. The load current value is no less than 4% of FS\_CCH.

### 4.1.63 IT8954A-1200-2160

Model		IT8954A-1200-2160	
Rated value ( 040 °C)	Input voltage	0~1200V	
	Input current	0~216A	0~2160A
	Input power	54KW	
	Min. operating voltage	1.2V/216A	12V/2160A
Constant voltage mode	Range	0.1~120V	0.1~1200V
	Resolution	10mV	100mV
	Accuracy	±(0.05%+0.05%FS)	±(0.05%+0.05%FS)
Constant current mode	Range	0~216A	0~2160A
	Resolution	10mA	100mA
	Accuracy	±(0.05%+0.1%FS)	±(0.1%+0.1%FS)
Constant resistance mode*1	Range	0.01Ω~10Ω	10Ω~7.5KΩ
	Resolution	16bit	
	Accuracy	0.01%+0.08S *2	0.01%+0.0008S
Constant power Mode*3	Range	54KW	
	Resolution	1W	
	Accuracy	0.2%+0.3%FS	
Dynamic Mode			
Dynamic Mode*4	CC Mode		
	Ascending/descending slope	0.01~2.7A/uS	0.1~27 A/uS
Measuring range			
Read-back voltage	Range	0~120V	0~1200V
	Resolution	10mV	100mV
	Accuracy	±(0.025%+0.025%FS)	±(0.025%+0.025%FS)
Read-back current	Range	0~216A	0~2160A
	Resolution	10mA	100mA
	Accuracy	±(0.05%+0.1%FS)	±(0.1%+0.1%FS)
Read-back power*2	Range	54KW	
	Resolution	1W	
	Accuracy	±(0.2%+0.3%FS)	
Protection range			

Model		IT8954A-1200-2160	
Overpower protection	≈54.5KW		
Overcurrent protection	≈226A	≈2260A	
Overvoltage protection	≈1250V		
Overtemperature protection	≈85°C		
Specification			
Short circuit	Current (CC)	≈226A	≈2260A
	Voltage (CV)	0V	0V
	Resistance (CR)	≈5.5mΩ	
Input terminal impedance	≈180KΩ		
Height	37U		

\*1. The voltage/current input is no less than 10%FS (FS indicates the full scope).

\*2. The scope of read-back resistance is  $(1/(1/R+(1/R)*0.01\%+0.08), 1/(1/R-(1/R)*0.01\%-0.08))$ .

\*3. The voltage/current input is no less than 10%FS.

\*4. The load current value is no less than 4% of FS\_CCH.

#### 4.1.64 IT8954E-150-2400

Model		IT8954E-150-2400	
Rated value ( 040 °C)	Input voltage	0~150V	
	Input current	0~240A	0~2400A
	Input power	54KW	
	Min. operating voltage	0.13V/240A	1.3V/2400A
Constant voltage mode	Range	0.1~18V	0.1~150V
	Resolution	1mV	10mV
	Accuracy	±(0.05%+0.05%FS)	±(0.05%+0.05%FS)
Constant current mode	Range	0~240A	0~2400A

Model		IT8954E-150-2400	
	Resolution	10mA	100mA
	Accuracy	$\pm(0.2\%+0.25\%FS)$	$\pm(0.2\%+0.25\%FS)$
Constant resistance mode*1	Range	0.005 $\Omega$ ~10 $\Omega$	10 $\Omega$ ~7.5K $\Omega$
	Resolution	16bit	
	Accuracy	0.01%+0.08S *2	0.01%+0.0008S
Constant power Mode*3	Range	54KW	
	Resolution	1W	
	Accuracy	0.35%+0.4%FS	
Dynamic Mode			
Dynamic Mode*4	CC Mode		
	Ascending/descending slope	0.01~2.88A/uS	0.1~28.8A/uS
Measuring range			
Read-back voltage	Range	0~18V	0~150V
	Resolution	1mV	10mV
	Accuracy	$\pm(0.025\%+0.025\%FS)$	$\pm(0.025\%+0.025\%FS)$
Read-back current	Range	0~240A	0~2400A
	Resolution	10mA	100mA
	Accuracy	$\pm(0.2\%+0.25\%FS)$	$\pm(0.2\%+0.25\%FS)$
Read-back power*2	Range	54KW	
	Resolution	1W	
	Accuracy	$\pm(0.35\%+0.4\%FS)$	
Protection range			
Overpower protection	$\approx 54.5KW$		
Overcurrent protection	$\approx 252A$	$\approx 2520A$	
Overvoltage protection	$\approx 157V$		
Overtemperature protection	$\approx 85^{\circ}C$		
Specification			
Short circuit	Current (CC)	$\approx 252A$	$\approx 2520A$
	Voltage (CV)	$\approx 0V$	$\approx 0V$

Model		IT8954E-150-2400
	Resistance (CR)	$\approx 0.54\text{m}\Omega$
Input terminal impedance		$\approx 90\text{K}\Omega$
Height		37U

\*1. The voltage/current input is no less than 10%FS (FS indicates the full scope).

\*2. The scope of read-back resistance is  $(1/(1/R+(1/R)*0.01\%+0.08), 1/(1/R-(1/R)*0.01\%-0.08))$ .

\*3. The voltage/current input is no less than 10%FS.

\*4. The load current value is no less than 4% of FS\_CCH.

## 4.1.65 IT8954E-600-2400

Model		IT8954E-600-2400	
Rated value ( 040 °C)	Input voltage	0~600V	
	Input current	0~240A	0~2400A
	Input power	54KW	
	Min. operating voltage	0.48V/240A	4.8V/2400A
Constant voltage mode	Range	0.1~60V	0.1~600V
	Resolution	1mV	10mV
	Accuracy	$\pm(0.05\%+0.05\%\text{FS})$	$\pm(0.05\%+0.05\%\text{FS})$
Constant current mode	Range	0~240A	0~2400A
	Resolution	10mA	100mA
	Accuracy	$\pm(0.1\%+0.15\%\text{FS})$	$\pm(0.1\%+0.15\%\text{FS})$
Constant resistance mode*1	Range	0.005 $\Omega$ ~10 $\Omega$	10 $\Omega$ ~7.5K $\Omega$
	Resolution	16bit	
	Accuracy	0.01%+0.08S *2	0.01%+0.0008S
Constant power Mode*3	Range	54KW	
	Resolution	1W	
	Accuracy	0.2%+0.3%FS	
Dynamic Mode			
Dynamic Mode*4	CC Mode		



Model		IT8954E-600-2400	
	Ascending/descending slope	0.01~2.88A/uS	0.1~28.8 A/uS
Measuring range			
Read-back voltage	Range	0~60V	0~600V
	Resolution	1mV	10mV
	Accuracy	$\pm(0.025\%+0.025\%FS)$	$\pm(0.025\%+0.025\%FS)$
Read-back current	Range	0~240A	0~2400A
	Resolution	10mA	100mA
	Accuracy	$\pm(0.1\%+0.15\%FS)$	$\pm(0.1\%+0.15\%FS)$
Read-back power*2	Range	54KW	
	Resolution	1W	
	Accuracy	$\pm(0.2\%+0.3\%FS)$	
Protection range			
Overpower protection	$\approx 54.5KW$		
Overcurrent protection	$\approx 252A$	$\approx 2520A$	
Overvoltage protection	$\approx 630V$		
Overtemperature protection	$\approx 85^{\circ}C$		
Specification			
Short circuit	Current (CC)	$\approx 252A$	$\approx 2520A$
	Voltage (CV)	$\approx 0V$	$\approx 0V$
	Resistance (CR)	$\approx 2m\Omega$	
Input terminal impedance	$\approx 110K\Omega$		
Height	37U		

\*1. The voltage/current input is no less than 10%FS (FS indicates the full scope).

\*2. The scope of read-back resistance is  $(1/(1/R+(1/R)*0.01\%+0.08), 1/(1/R-(1/R)*0.01\%-0.08))$ .

\*3. The voltage/current input is no less than 10%FS.

\*4. The load current value is no less than 4% of FS\_CCH.

## 4.1.66 IT8954E-1200-2160

Model		IT8954E-1200-2160	
Rated value ( 040 °C)	Input voltage	0~1200V	
	Input current	0~216A	0~2160A
	Input power	54KW	
	Min. operating voltage	1.2V/216A	12V/2160A
Constant voltage mode	Range	0.1~120V	0.1~1200V
	Resolution	10mV	100mV
	Accuracy	±(0.05%+0.05%FS)	±(0.05%+0.05%FS)
Constant current mode	Range	0~216A	0~2160A
	Resolution	10mA	100mA
	Accuracy	±(0.1%+0.1%FS)	±(0.1%+0.1%FS)
Constant resistance mode*1	Range	0.01Ω~10Ω	10Ω~7.5KΩ
	Resolution	16bit	
	Accuracy	0.01%+0.08S *2	0.01%+0.0008S
Constant power Mode*3	Range	54KW	
	Resolution	1W	
	Accuracy	0.2%+0.3%FS	
Dynamic Mode			
Dynamic Mode*4	CC Mode		
	Ascending/descending slope	0.01~2.25A/uS	0.1~22.5 A/uS
Measuring range			
Read-back voltage	Range	0~120V	0~1200V
	Resolution	10mV	100mV
	Accuracy	±(0.025%+0.025%FS)	±(0.025%+0.025%FS)
Read-back current	Range	0~216A	0~2160A
	Resolution	10mA	100mA
	Accuracy	±(0.1%+0.1%FS)	±(0.1%+0.1%FS)
Read-back power*2	Range	54KW	
	Resolution	1W	
	Accuracy	±(0.2%+0.3%FS)	
Protection range			

Model		IT8954E-1200-2160	
Overpower protection	≈54.5KW		
Overcurrent protection	≈226A	≈2260A	
Overvoltage protection	≈1250V		
Overtemperature protection	≈85°C		
Specification			
Short circuit	Current (CC)	≈226A	≈2260A
	Voltage (CV)	≈0V	≈0V
	Resistance (CR)	≈5.5mΩ	
Input terminal impedance	≈180KΩ		
Height	37U		

\*1. The voltage/current input is no less than 10%FS (FS indicates the full scope).

\*2. The scope of read-back resistance is  $(1/(1/R+(1/R)*0.01\%+0.08), 1/(1/R-(1/R)*0.01\%-0.08))$ .

\*3. The voltage/current input is no less than 10%FS.

\*4. The load current value is no less than 4% of FS\_CCH.

### 4.1.67 IT8960E-600-2400

Model		IT8960E-600-2400	
Rated value ( 0~40 °C)	Input voltage	0~600V	
	Input current	0~240A	0~2400A
	Input power	60KW	
	Min. operating voltage	0.48V/240A	4.8V/2400A
Constant voltage mode	Range	0.1~60V	0.1~600V
	Resolution	1mV	10mV
	Accuracy	±(0.05%+0.05%FS)	±(0.05%+0.05%FS)
Constant current mode	Range	0~240A	0~2400A

Model		IT8960E-600-2400	
	Resolution	10mA	100mA
	Accuracy	$\pm(0.1\%+0.1\%FS)$	$\pm(0.1\%+0.1\%FS)$
Constant resistance mode*1	Range	0.005 $\Omega$ ~10 $\Omega$	10 $\Omega$ ~7.5K $\Omega$
	Resolution	16bit	
	Accuracy	0.01%+0.08S *2	0.01%+0.0008S
Constant power Mode*3	Range	60KW	
	Resolution	1W	
	Accuracy	0.2%+0.3%FS	
Measuring range			
Read-back voltage	Range	0~60V	0~600V
	Resolution	1mV	10mV
	Accuracy	$\pm(0.025\%+0.025\%FS)$	$\pm(0.025\%+0.025\%FS)$
Read-back current	Range	0~240A	0~2400A
	Resolution	10mA	100mA
	Accuracy	$\pm(0.1\%+0.1\%FS)$	$\pm(0.1\%+0.1\%FS)$
Read-back power*2	Range	60KW	
	Resolution	1W	
	Accuracy	$\pm(0.2\%+0.3\%FS)$	
Protection range			
Overpower protection	$\approx 60.6KW$		
Overcurrent protection	$\approx 264A$	$\approx 2640A$	
Overvoltage protection	$\approx 630V$		
Overtemperature protection	$\approx 85^{\circ}C$		
Specification			
Short circuit	Current (CC)	$\approx 264A$	$\approx 2640A$
	Voltage (CV)	$\approx 0V$	$\approx 0V$
	Resistance (CR)	$\approx 2m\Omega$	
Input terminal impedance	$\approx 100K\Omega$		

\*1.The voltage/current input is no less than 10%FS (FS indicates the full scope).

\*2.The scope of read-back resistance is  $(1/(1/R+(1/R)*0.01\%+0.08), 1/(1/R-(1/R)*0.01\%-0.08))$ .

\*3.The voltage/current input is no less than 10%FS.

## 4.2 Additional features

Memory capacity: 100 groups.

Recommended calibration frequency: 1 time/year.

Cooling method: fan.

# 5 References of Load Communication Interfaces

- ◆ RS-232 interface
- ◆ USB interface
- ◆ GPIB interface
- ◆ LAN interface

IT8900A/E series electronic load is provided with four communication interfaces to communicate with a computer for selection, including RS-232, USB, GPIB and LAN. The customer can choose any one according to his demands.

## 5.1 RS-232 interface

Cable connection load with both ends of COM interface (DB9) and computer. Composite key **[Shift] + 8(System)** on front board can be used to enter system menu for activation.

In RS-232 interface, all SCPI commands can be used for programming. If RS-232 interface is selected, in accordance with internal connection of data terminal equipment (DTE) and data communication equipment (DCE) as defined in EIA RS-232, the load is connected to another DTE (e.g., PC COM interface) with direct-connected Modem cable.



### Note

RS-232 setting in procedure should be consistent with that in system menu of front board. Press composite key **[Shift] + 8(System)** to change (if necessary). Send a ^C or ^X character string to the load to pause data transmission. It will clear any uncompleted operation and waive any uncompleted output.

### RS-232 data format

RS-232 data comprises start bit, odd and even parity check bit, stop bit and 8-bit data bit. Start bit and stop bit are not editable. However, next odd or even item can be selected by front board **[Shift] + 8(System)**. The odd and even items are saved in NVM.

### Baud rate

Through front board **[Shift] + 8(System)**, the user may select one Baud rate saved in NVM: 4800 /9600 /19200 /38400 /57600 /115200

## RS-232 Connection

Use RS-232 cable with DB-9 interface because the RS-232 serial port can be connected controller (e.g. PC) serial port. Do not use modulating cable of air-conditioner. Refer to Table 2-2 for plug pin.

If your computer is provided with a RS-232 interface with DB-25 plug, a cable and a adapter with DB-25 plug (one end) and DB-9 plug (the other end) are required (not the modulating cable of the air-conditioner).

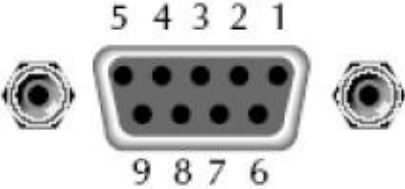
RS232 Pins of Plug	Pin number	Description
	1	No conjunction
	2	TXD, data transmission
	3	RXD, data receiving
	4	No conjunction
	5	GND, grounding
	6	No conjunction
	7	CTS, clear to send
	8	RTS, request to send
	9	No conjunction

## RS-232 troubleshooting

In case of connection failure of RS-232, perform following check:

- Check if the computer and load are provided with same Baud rate, parity check bit, data bit and flow control. The power shall be configured with one start bit (fixed) and one stop bit (fixed).
- Just as described in the RS-232 connector, correct interface cable or adapter shall be adopted. Note: even if the cable is equipped with right plug, internal wiring may be incorrect.
- The interface cable must be connected to the correct serial port (COM1, COM2, etc.) of the computer.

## Setting of communication

Before communication operation, be sure to match load and PC parameters (as follows).

Baud rate: 9600 (4800/9600/19200/38400/57600/15200). You may enter system menu through the board to set communication Baud rate.

Data bit: 8 bits

Stop bit: 1 bit

Check: none

Start Bit	8 Data Bits	Parity=None	Stop Bit
-----------	-------------	-------------	----------

## 5.2 USB interface

Connect the load and the computer using a cable with two USB interfaces (each end). All functions of the load can be programmed via USB.

The functions of load USB488 interface are as follows:

- The interface is 488.2 USB488 Interface.
- The interface receives requests of REN\_CONTROL, GO\_TO\_LOCAL and LOCAL\_LOCKOUT.
- The interface receives the command MsgID=TRIGGER USBTMC and conveys the TRIGGER command to the functional layer.

The functions of load USB488 device are as follows:

- Capable to read all common SCPI commands.
- SR1 enabled.
- RL1 enabled.
- DT1 enabled.

## 5.3 GPIB interface

Firstly, connect load GPIB interface and computer GPIB card through IEEE488 bus and ensure sufficient contact. Tighten them with screws. Set address. Load address range: 0 to 31. Press **[Shift] + 8**(System) to enter system menu functions. Press Left/Right key to find Communication. Select GPIB and set address. Input address and press **[Enter]** for confirmation. The load works by setting GPIB address on front board. GPIB address is saved in NVM.



## 5.4 LAN interface

Press **[Shift] + 8**(System) button to enter the system set. Please select “LAN” in the Communication from System and then configure Gateway, IP, Mask and Socket Port in the LAN option.

Connect the LAN interface of load to the computer with a reticle (crossed). The gateway address should be consistent with that of the PC, and the IP address should be at the same network segment with the PC's IP address.

# A Appendix

- ◆ Specifications of Red and Black Test Lines
- ◆ Fuse Replacement

## A.1 Specifications of Red and Black Test Lines

ITECH provides you with optional red and black test lines, which are sold individually and you can select for test. For specifications of ITECH test lines and maximum current values, refer to the table below.

Model	Specification	Cross Section	Length
IT-E301/10A	10A	-	1m
IT-E301/30A	30A	6mm <sup>2</sup>	1.2m
IT-E301/30A	30A	6mm <sup>2</sup>	2m
IT-E301/60A	60A	20mm <sup>2</sup>	1.5m
IT-E301/120A	120A	50mm <sup>2</sup>	2m
IT-E301/240A	240A	70mm <sup>2</sup>	1m
IT-E301/240A	240A	70mm <sup>2</sup>	2m
IT-E301/360A	360A	95mm <sup>2</sup>	2m

For maximum current of AWG copper wire, refer to table blow.

AWG	10	12	14	16	18	20	22	24	26	28
The Maximum Current Value( A)	40	25	20	13	10	7	5	3.5	2.5	1.7



### Note

AWG ( American Wire Gage), it means X wire ( marked on the wire). The table above lists current capacity of single wire at working temperature of 30°C. For reference only.

---



## A.2 Fuse Replacement



Different models of our company product are supplied with different fuse assembly. The way to replace the fuse changes accordingly. The common ways are as follows. Please choose the corresponding way of disassembly and replacement based on the fuse assembly of the actual instrument.

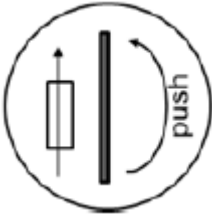
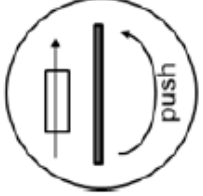
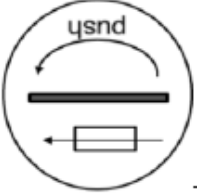
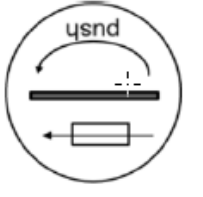
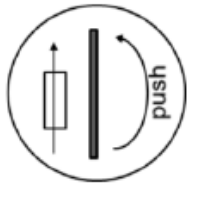

### Note

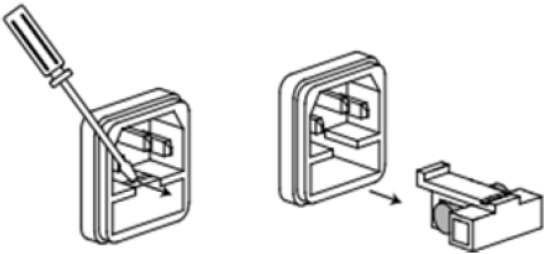
If there are no fuse assembly on the instrument rear panel, it means that you can't replace the fuse by yourself. Please contact the ITECH engineer on the condition of the same malfunction.

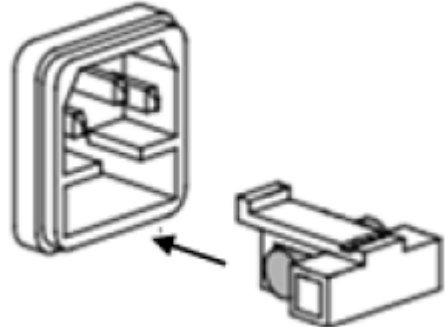
The type of the fuse	The way to replace
	<ol style="list-style-type: none"> <li>1. Use a screwdriver to push and turn the fuse box anti-clockwise. When turned to 90 degrees, release the screwdriver. Refer to the picture below.</li> </ol>   <ol style="list-style-type: none"> <li>2. The fuse box will bounce up, then you can see the fuse in it. Take out the blown fuse.</li> <li>3. Please replace with a fuse of the same specification. Refer to the technical specification of the corresponding instrument.</li> <li>4. When install, put into the fuse box as the picture below. Then use a screwdriver to push and turn the fuse box to 90 degrees clockwise. Refer to the picture below.</li> </ol>  
	<p>The power cord jack of the instrument includes the fuse. Please refer to the rear panel introduction of the corresponding instrument for the detailed position. The replacement steps for this type of the fuse are as follows.</p> <ol style="list-style-type: none"> <li>1. First pull out the power cord, and then take out the fuse block from the power cord jack with a small screwdriver, as shown below.</li> </ol>  <ol style="list-style-type: none"> <li>2. Have a visual inspection of the fuse to see whether it is burnt out; if yes, replace it with another fuse of the same specification. Refer to the corresponding technical specifications for fuse rating.</li> </ol>

The type of the fuse	The way to replace
	<p>3. After replacement, mount the fuse block to the original position, as illustrated below.</p> 
	<ol style="list-style-type: none"> <li>1. Push and turn the fuse box anti-clockwise by hand. When turned to 90 degrees, release the screwdriver.</li> <li>2. The fuse box will bounce up, then you can see the fuse in it. Take out the blown fuse.</li> <li>3. Please replace with a fuse of the same specification. Refer to the technical specification of the corresponding instrument.</li> <li>4. When install, put into the fuse box firstly. Then Push and turn the fuse box to 90 degrees clockwise.</li> </ol>

## Contact Us

Thanks for purchasing ITECH products. In case of any doubts, please contact us as follows:

1. Refer to accompanying data disk and relevant manual.
2. Visit ITECH website: [www.itechate.com](http://www.itechate.com).
3. Select the most convenient contact method, for further information.