

High power and Programmable Switching Power supply

IT6500C Series User Manual

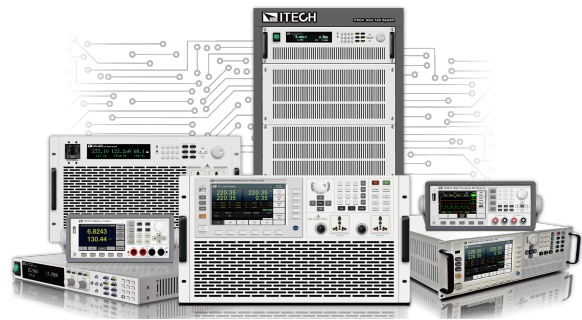

Model: IT6512C/IT6513C/IT6514C/IT6515C/IT6516C/
IT6517C/ IT6522C/IT6523C/IT6524C/IT6525C/
IT6526C/IT6527C/ IT6532C/IT6533C/IT6534C/
IT6535C/IT6536C/IT6537C/IT6542C/IT6543C/
IT6544C/IT6545C/IT6546C/IT6547C/IT6552C/
IT6553C/IT6554C/IT6555C/IT6556C/IT6557C/
IT6562C/IT6563C/IT6564C/IT6565C/IT6566C/
IT6567C/6572C/IT6573C/IT6574C/IT6575C/
IT6576C/IT6577C/IT6582C/IT6583C/IT6584C/
IT6585C/IT6586C/IT6587C/IT6592C/IT6593C/
IT6594C/IT6595C/IT6596C/IT6597C

Version: V4.7/9,2019

Notices

© Itech Electronic, Co., Ltd. 2019

No part of this manual may be reproduced in any form or by any means (including electronic storage and retrieval or translation into a foreign language) without prior permission and written consent from Itech Electronic, Co., Ltd. as governed by international copyright laws.

Manual Part Number



402225

Trademarks

Pentium is U.S. registered trademarks of Intel Corporation.

Microsoft, Visual Studio, Windows and MS Windows are registered trademarks of Microsoft Corporation in the United States and/or other countries and regions.

Warranty

The materials contained in this document are provided “as is”, and is subject to change, without prior notice, in future editions. Further, to the maximum extent permitted by applicable laws, ITECH disclaims all warranties, either express or implied, with regard to this manual and any information contained herein, including but not limited to the implied warranties of merchantability and fitness for a particular purpose. ITECH shall not be held liable for errors or for incidental or indirect damages in connection with the furnishing, use or application of this document or of any information contained herein. Should ITECH and the user enter into a separate written agreement with warranty terms covering the materials in this document that conflict with these terms, the warranty terms in the separate agreement shall prevail.

Technology Licenses

The hardware and/or software described herein are furnished under a license and may be used or copied only in accordance with the terms of such license.

Restricted Rights Legend

Restricted permissions of the U.S. government. Permissions for software and technical data which are authorized to the U.S. Government only include those for custom provision to end users. ITECH follows FAR 12.211 (technical data), 12.212 (computer software). DFARS 252.227-7015 (technical data—commercial products) for national defense and DFARS 227.7202-3 (permissions for commercial computer software or computer software documents) while providing the customized business licenses of software and technical data.

Safety Notices

CAUTION

A CAUTION sign denotes a hazard. It calls attention to an operating procedure or practice that, if not correctly performed or adhered to, could result in damage to the product or loss of important data. Do not proceed beyond a CAUTION sign until the indicated conditions are fully understood and met.

WARNING

A WARNING sign denotes a hazard. It calls attention to an operating procedure or practice that, if not correctly performed or adhered to, could result in personal injury or death. Do not proceed beyond a WARNING sign until the indicated conditions are fully understood and met.



Note

A NOTE sign denotes important hint. It calls attention to tips or supplementary information that is essential for users to refer to.

Quality Certification and Assurance

We certify that series instrument meets all the published specifications at time of shipment from the factory.

Warranty

ITECH warrants that the product will be free from defects in material and workmanship under normal use for a period of one (1) year from the date of delivery (except those described in the Limitation of Warranty below).

For warranty service or repair, the product must be returned to a service center designated by ITECH.















- The product returned to ITECH for warranty service must be shipped PRE-PAID. And ITECH will pay for return of the product to customer.
- If the product is returned to ITECH for warranty service from overseas, all the freights, duties and other taxes shall be on the account of customer.

Limitation of Warranty

This Warranty will be rendered invalid in case of the following:

- Damage caused by circuit installed by customer or using customer own products or accessories;
- Modified or repaired by customer without authorization;
- Damage caused by circuit installed by customer or not operating our products under designated environment;
- The product model or serial number is altered, deleted, removed or made illegible by customer;
- Damaged as a result of accidents, including but not limited to lightning, moisture, fire, improper use or negligence.

Safety Symbols

	Direct current		ON (power)
	Alternating current		OFF (power)
	Both direct and alternating current		Power-on state
	Chassis (earth ground) symbol.		Power-off state
	Earth (ground) terminal		Reference terminal
	Caution		Positive terminal
	Warning (refer to this manual for specific Warning or Caution information)		Negative terminal
	A chassis terminal	-	-

Safety Precautions

The following safety precautions must be observed during all phases of operation of this instrument. Failure to comply with these precautions or specific warnings elsewhere in this manual will constitute a default under safety standards of design, manufacture and intended use of the instrument. ITECH assumes no liability for the customer's failure to comply with these precautions.

WARNING

- Do not use the instrument if it is damaged. Before operation, check the casing to see whether it cracks. Do not operate the instrument in the presence of inflammable gasses, vapors or dusts.
 - The instrument is provided with a power cord during delivery and should be connected to a socket with a protective earth terminal, a junction box or a three-phase distribution box. Before operation, be sure that the instrument is well grounded.
 - Please always use the provided cable to connect the instrument.
 - Check all marks on the instrument before connecting the instrument to power supply.
 - Ensure the voltage fluctuation of mains supply is less than 10% of the working voltage range in order to reduce risks of fire and electric shock.
 - Do not install alternative parts on the instrument or perform any unauthorized modification.
 - Do not use the instrument if the detachable cover is removed or loosen.
 - To prevent the possibility of accidental injuries, be sure to use the power adapter supplied by the manufacturer only.
 - We do not accept responsibility for any direct or indirect financial damage or loss of profit that might occur when using the instrument.
 - This instrument is used for industrial purposes, do not apply this product to IT power supply system.
 - Never use the instrument with a life-support system or any other equipment subject to safety requirements.
-

WARNING

- **SHOCK HAZARD Ground the Instrument.** This product is provided with a protective earth terminal. To minimize shock hazard, the instrument must be connected to the AC mains through a grounded power cable, with the ground wire firmly connected to an electrical ground (safety ground) at the power outlet or distribution box. Any interruption of the protective (grounding) conductor or disconnection of the protective earth terminal will cause a potential shock hazard that could result in injury or death.
- Before applying power, verify that all safety precautions are taken. All connections must be made with the instrument turned off, and must be performed by qualified personnel who are aware of the hazards involved. Improper actions can cause fatal injury as well as equipment damage.
- **SHOCK HAZARD, LETHAL VOLTAGES** This product can output the dangerous voltage that can cause personal injury, and the operator must always be protected from electric shock. Ensure that the output electrodes are either insulated or covered using the safety covers provided, so that no accidental contact with lethal voltages can occur.
- Never touch cables or connections immediately after turning off the instrument. Verify that there is no dangerous voltage on the electrodes or sense terminals before touching them.

CAUTION

- Failure to use the instrument as directed by the manufacturer may render its protective features void.
- Always clean the casing with a dry cloth. Do not clean the internals.
- Make sure the vent hole is always unblocked.

Environmental Conditions

The instrument is designed for indoor use and an area with low condensation. The table below shows the general environmental requirements for the instrument.

Environmental Conditions	Requirements
Operating temperature	0°C ~ 40°C
Operating humidity	20% ~ 80%(non-condensation)
Storage temperature	-10°C ~ 70 °C

Environmental Conditions	Requirements
Altitude	Operating up to 2,000 meters
Installation category	II
Pollution degree	Pollution degree 2



Note

In order to ensure the accuracy of measurement, it is recommended to operate the instrument half an hour after start-up.

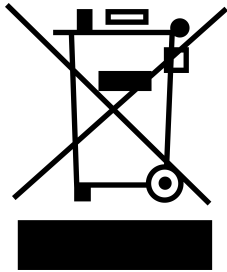
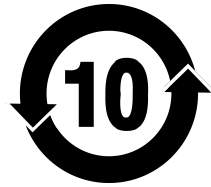
Regulation Tag

	<p>The CE tag shows that the product complies with the provisions of all relevant European laws (if the year is shown, it indicates that the year when the design is approved).</p>
	<p>This instrument complies with the WEEE directive (2002/96/EC) tag requirements. This attached product tag shows that the electrical/electronic product cannot be discarded in household waste.</p>
	<p>This symbol indicates that no danger will happen or toxic substances will not leak or cause damage in normal use within the specified period. The service life of the product is 10 years. The product can be used safely within the environmental protection period; otherwise, the product should be put into the recycling system.</p>

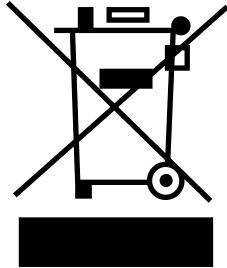
Waste Electrical and Electronic Equipment (WEEE) Directive



Waste electrical and electronic equipment (WEEE) directive, 2002/96/EC

The product complies with tag requirements of the WEEE directive (2002/96/EC). This tag indicates that the electronic equipment cannot be disposed of as ordinary household waste. Product Category

According to the equipment classification in Annex I of the WEEE directive, this instrument belongs to the "Monitoring" product.

If you want to return the unnecessary instrument, please contact the nearest sales office of ITECH.

Compliance Information

Complies with the essential requirements of the following applicable European Directives, and carries the CE marking accordingly:

- Electromagnetic Compatibility (EMC) Directive 2014/30/EU
- Low-Voltage Directive (Safety) 2014/35/EU

Conforms with the following product standards:

EMC Standard

IEC 61326-1:2012/ EN 61326-1:2013 ¹²³

Reference Standards

CISPR 11:2009+A1:2010/ EN 55011:2009+A1:2010 (Group 1, Class A)

IEC 61000-4-2:2008/ EN 61000-4-2:2009

IEC 61000-4-3:2006+A1:2007+A2:2010/ EN 61000-4-3:2006+A1:2008+A2:2010

IEC 61000-4-4:2004+A1:2010/ EN 61000-4-4:2004+A1:2010

IEC 61000-4-5:2005/ EN 61000-4-5:2006

IEC 61000-4-6:2008/ EN 61000-4-6:2009

IEC 61000-4-11:2004/ EN 61000-4-11:2004

1. The product is intended for use in non-residential/non-domestic environments. Use of the product in residential/domestic environments may cause electromagnetic interference.
2. Connection of the instrument to a test object may produce radiations beyond the specified limit.
3. Use high-performance shielded interface cable to ensure conformity with the EMC standards listed above.

Safety Standard

IEC 61010-1:2010/ EN 61010-1:2010

Content

Quality Certification and Assurance	I
Warranty	I
Limitation of Warranty	I
Safety Symbols	II
Safety Precautions	II
Environmental Conditions	IV
Regulation Tag	V
Waste Electrical and Electronic Equipment (WEEE) Directive	VI
Compliance Information	VII
1 Inspection and Installation	1
1.1 Verifying the Shipment	1
1.2 Instrument Size Introduction	2
1.3 Connecting the Power Cord	7
1.4 Connecting the Device Under Test (DUT)	10
2 Quick Reference	14
2.1 Brief Introduction	14
2.2 Front Panel Introduction	17
2.3 Keyboard Introduction	18
2.4 Rotary Knob and Coarse/Fine Button Introduction	19
2.5 VFD Indicator Lamps Description	20
2.6 Rear Panel Introduction	21
2.7 Power-on Selftest	24
3 Function and Features	27
3.1 Setting Voltage	27
3.2 Setting Current	28
3.3 Setting Power	28
3.4 Output On/Off Button	28
3.5 Switching Setting Value and Actual Value	29
3.6 Switching Local/Remote Mode	29
3.7 Key Lock Function	29
3.8 Save/Recall Operation	30
3.8.1 Setting Group Number	30
3.8.2 Save Operation	31
3.8.3 Recall Operation	31
3.9 System Menu	31
3.9.1 Restored to Factory Setting(Reset)	35
3.9.2 Power On Parameter(Power-on)	36
3.9.3 Trigger Mode (Trigger)	37
3.9.4 Key Sound Set (Buzzer)	37
3.9.5 Communication Set (Communication)	37
3.9.6 Return to Meter state (Return Meter)	38
3.9.7 Power On Output State (P-OUT)	38
3.9.8 Setting Filter	38
3.10 Setup Menu	39
3.11 Setting Output Rise Time/Fall Time	41
3.12 Protection Function	41
3.13 Setting Maximum and Minimum Values	45
3.14 Load Function	45
3.15 Charge Protection	48
3.16 Static Protection Function of Battery	49
3.17 Internal Resistance Setting	49
3.18 CC/CV Priority	50
3.19 LIST Operation	52
3.20 PV Simulation	56
3.21 Built-in Waveform	59

3.21.1	Automotive Starting Waveform.....	64
3.21.2	simulate the waveform to verify the anti-interference performance of the automotive electronics' products	67
3.21.3	42V Road vehicles — Electrical and electronic equipment for a supply voltage of 42 V — Electrical loads	74
3.21.4	SAEJ1113-11 Waveform protocol.....	77
3.21.5	LV124.....	78
3.22	DC Internal Resistance Measure.....	82
3.23	Parallel Operation	83
3.24	Analogue Interface (Enhanced Isolation)	85
4	Remote Control	93
4.1	RS232 Interface	93
4.2	USB Interface.....	95
4.3	GPIB Interface	95
4.4	LAN Interface	96
4.4.1	Using the Web Interface	99
4.4.2	Using Telnet.....	100
4.4.3	Using Sockets.....	100
4.5	CAN Communication Port.....	101
5	Technical Specification.....	103
5.1	Main Technical Parameters	103
5.1.1	IT6512C	103
5.1.2	IT6522C	105
5.1.3	IT6532C	107
5.1.4	IT6542C	110
5.1.5	IT6552C	112
5.1.6	IT6562C	114
5.1.7	IT6572C	117
5.1.8	IT6582C	119
5.1.9	IT6592C	121
5.1.10	IT6513C	123
5.1.11	IT6523C	126
5.1.12	IT6533C	128
5.1.13	IT6543C	130
5.1.14	IT6553C	132
5.1.15	IT6563C	134
5.1.16	IT6573C	137
5.1.17	IT6583C	139
5.1.18	IT6593C	141
5.1.19	IT6514C	144
5.1.20	IT6524C	146
5.1.21	IT6534C	148
5.1.22	IT6544C	150
5.1.23	IT6554C	153
5.1.24	IT6564C	155
5.1.25	IT6574C	157
5.1.26	IT6584C	160
5.1.27	IT6594C	162
5.1.28	IT6515C	164
5.1.29	IT6525C	166
5.1.30	IT6535C	169
5.1.31	IT6545C	171
5.1.32	IT6555C	173
5.1.33	IT6565C	175
5.1.34	IT6575C	178
5.1.35	IT6585C	180
5.1.36	IT6595C	182
5.1.37	IT6516C	184

5.1.38	IT6526C	187
5.1.39	IT6536C	189
5.1.40	IT6546C	191
5.1.41	IT6556C	194
5.1.42	IT6566C	196
5.1.43	IT6576C	198
5.1.44	IT6586C	200
5.1.45	IT6596C	203
5.1.46	IT6517C	205
5.1.47	IT6527C	207
5.1.48	IT6537C	210
5.1.49	IT6547C	212
5.1.50	IT6557C	214
5.1.51	IT6567C	216
5.1.52	IT6577C	219
5.1.53	IT6587C	221
5.1.54	IT6597C	223
5.2	Supplemental characteristics	226
A	Appendix	227
A.1	Specifications of Red and Black Test Cables	227
A.2	How to avoid it couldn't start when test battery	228
A.3	Fuse Replacement	229

1 Inspection and Installation

- ◆ Verifying the Shipment
- ◆ Instrument Size Introduction
- ◆ Connecting the Power Cord
- ◆ Connecting the Device Under Test (DUT)

1.1 Verifying the Shipment

Unpack the box and check the contents before operating the instrument. If wrong items have been delivered, if items are missing, or if there is a defect with the appearance of the items, contact the dealer from which you purchased the instrument immediately.

The package contents include:

Item	Qty.	Model	Remarks
power supply	x1	IT6500C series	This series include : IT6512C/IT6513C/IT6514C/ IT6515C/IT6516C/IT6517C/ IT6522C/IT6523C/IT6524C/ IT6525C/IT6526C/IT6527C/ IT6532C/IT6533C/IT6534C/ IT6535C/IT6536C/IT6537C/ IT6542C/IT6543C/IT6544C/ IT6545C/IT6546C/IT6547C/ IT6552C/IT6553C/IT6554C/ IT6555C/IT6556C/IT6557C/ IT6562C/IT6563C/IT6564C/ IT6565C/IT6566C/IT6567C/ IT6572C/IT6573C/IT6574C/ IT6575C/IT6576C/IT6577C/ IT6582C/IT6583C/IT6584C/ IT6585C/IT6586C/IT6587C/ IT6592C/IT6593C/IT6594C/ IT6595C/IT6596C/IT6597C
Power cord	x1	-	Number of the power cords vary depending on the model, See the Section 1.3 Connecting the Power Cord for power cord connection.

Item	Qty.	Model	Remarks
USB cable	x1	-	This accessory is selected when the USB interface is used for starting up remote operation.
CD	x1	-	It contains power supply User's Manual, Programming Guide and other user documentations.
Ex-factory Test Report	x1	-	It is the test report of the instrument before delivery.

Note

Upon verification of the shipment, keep the package and relevant contents thereof in a safe place. When returning the instrument for warranty service or repair, the specified packing requirements shall be met.

1.2 Instrument Size Introduction

The instrument should be installed at well-ventilated and rational-sized space. Please select appropriate space for installation based on the instrument size.

IT6500C series power supply different models are not the same size, the detail size of the power supply are shown as below.

2U Model

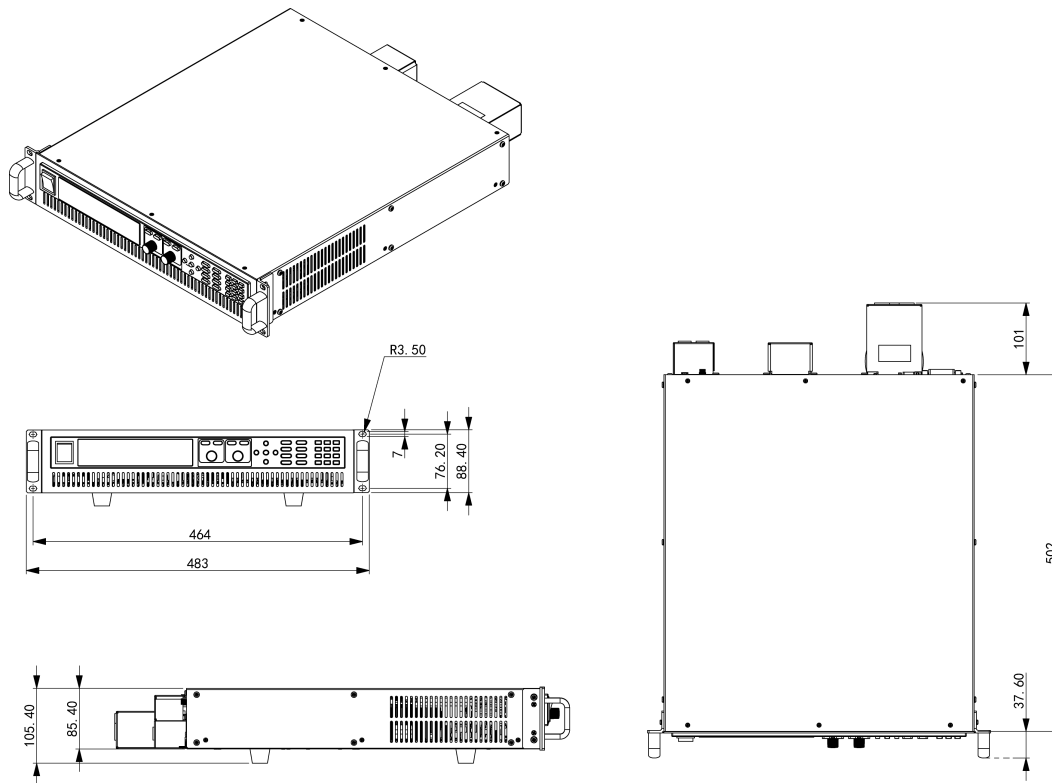

4U Model

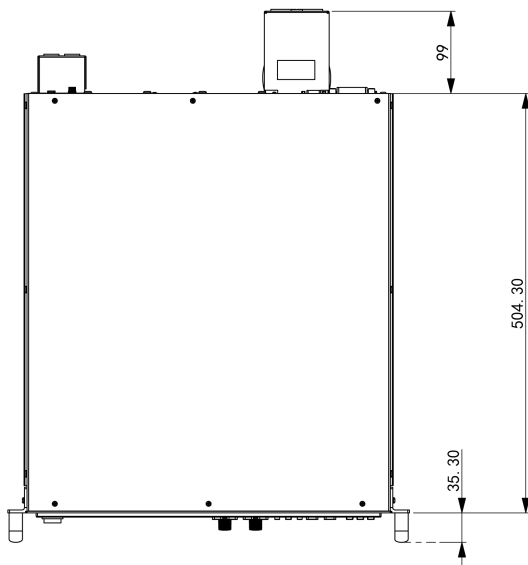
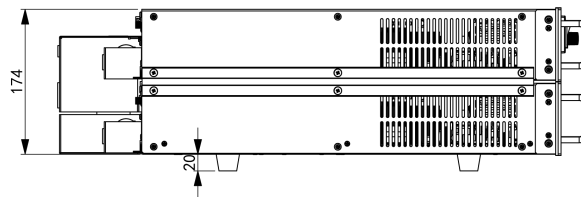
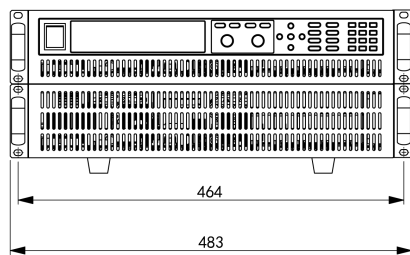
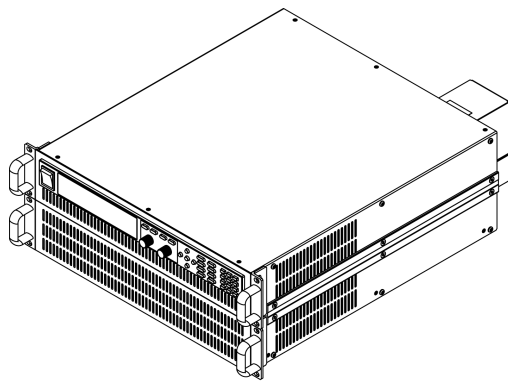

6U Model

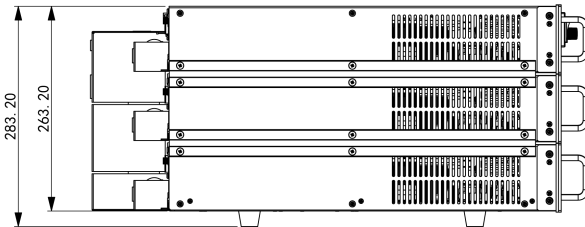
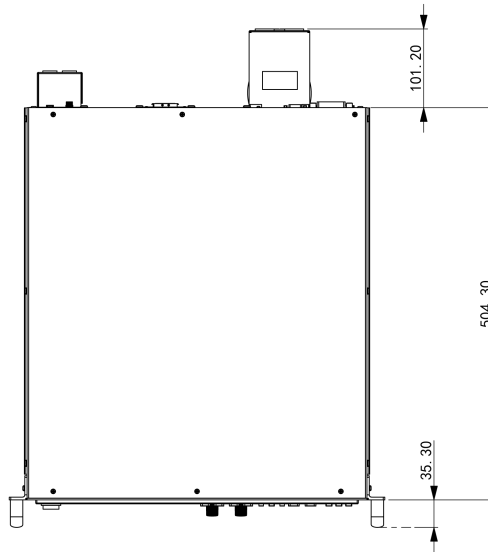
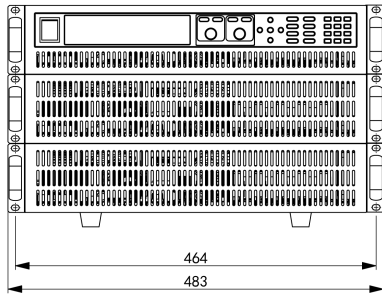
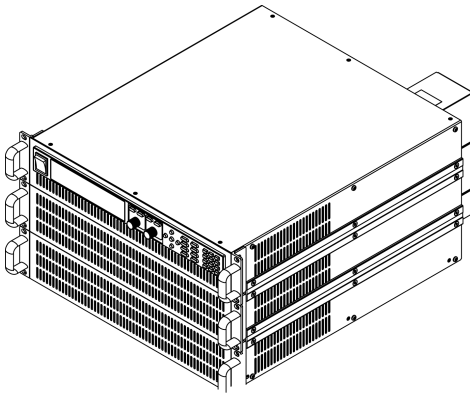

15U Model

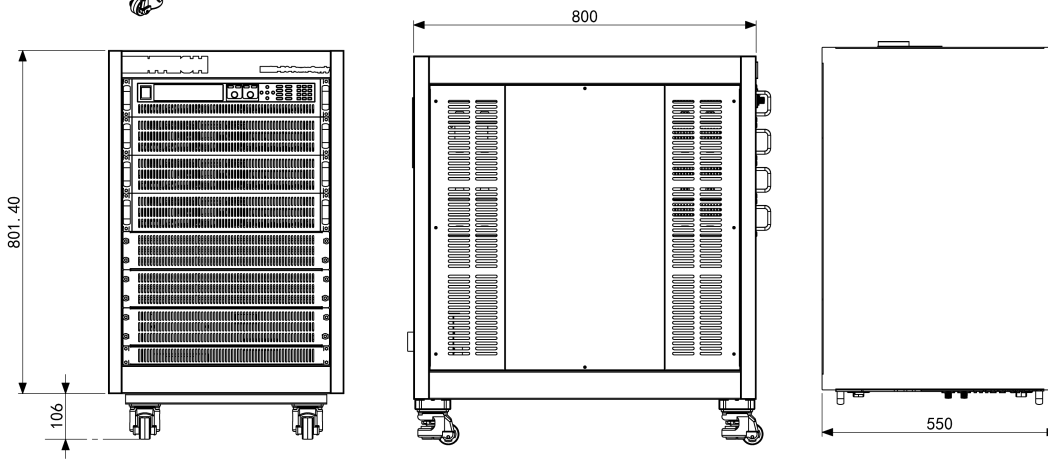
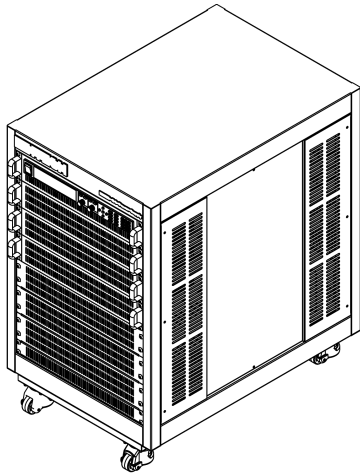

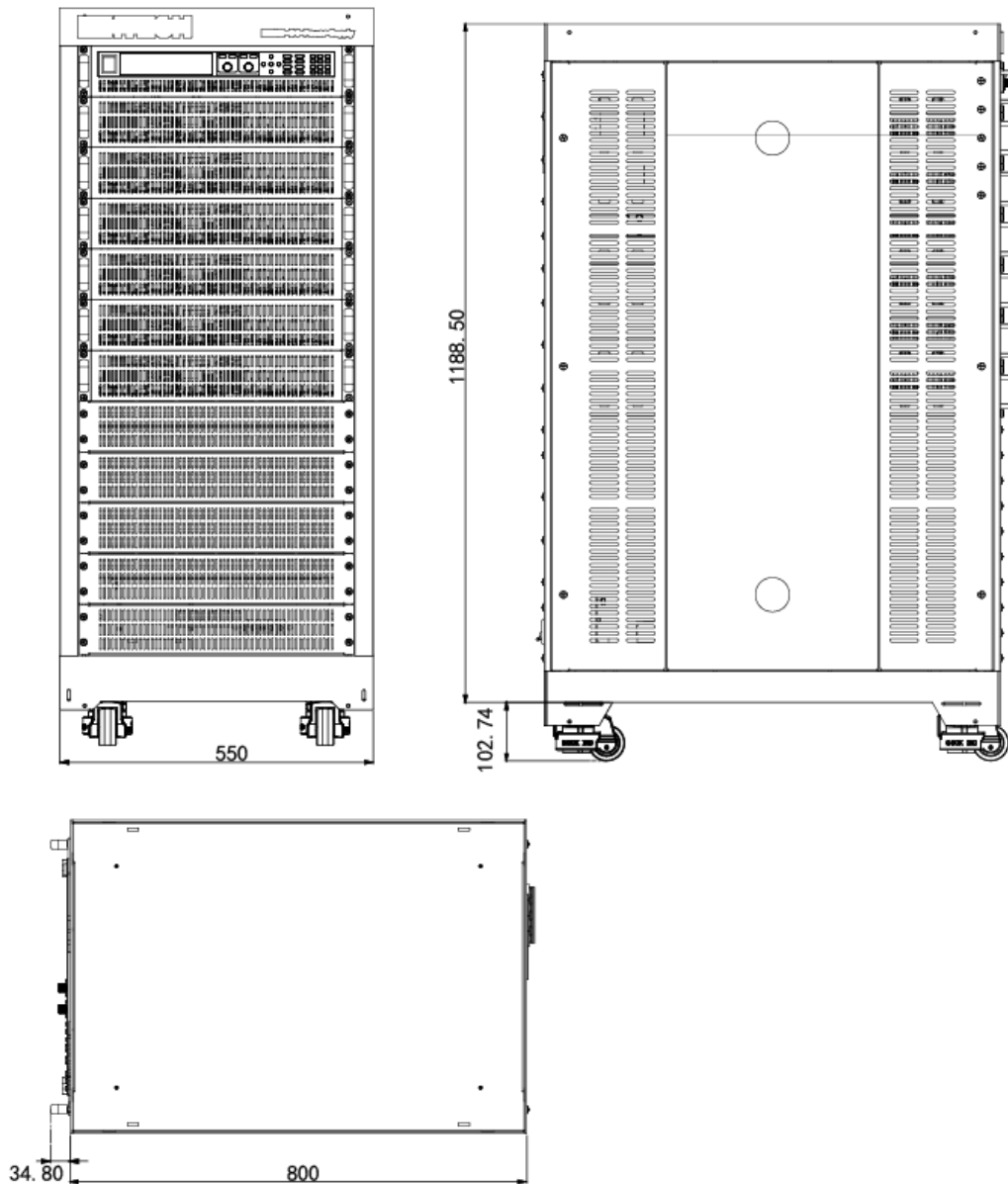
24U Model

1.3 Connecting the Power Cord

AC Power Input Level

IT6500C series contains many models. Different model required different power ratings. Detailed AC input and maximum input apparent power refer to corresponding specification.

Note

IT6500C Series power supply can also work in 110V voltage circumstances. However, the output power is limited. For full-power output, please according to the specification and use 220V±10% voltage or 380V±10% voltage.

Before Connecting the Power Cord
WARNING

- Before connecting power cord, be sure to confirm that the power voltage matches with the supply voltage.
- Before connecting power cord, be sure to switch off the instrument. Power switch is in Off position.
- To avoid fire or electric shock, Make sure to use the power cord supplied by ITECH.
- Be sure to connect the main power socket to the power outlet with protective grounding. Do not use terminal board without protective grounding.
- The instrument rear panel provides a separate screw used for chassis ground. Please make proper connections. In the event of a failure, not using a properly grounded protective earth and grounded outlet may result in personal injury or death due to electric shock.
- The power cords supplied with this product is certified for safety. In case the supplied lines assembly needs to be replaced, or an extension lines must be added, be sure that it can meet the required power ratings of this product. Any misuse voids the warranty of this product.

Power Cord Type and Connecting Method

IT6500C series contains many models. Different model is supplied with different power cord. The power cord and connection of different models are introduced as follow.

- IT6512C to IT6537C series power supply provides the standard power cords as below.

The IT6532C to IT6537C series power supply consist of two power supply units, and ITECH provides two power lines during delivery. The user needs to connect each power supply unit to the AC 220V power source.



Connecting Method:

1. See the below illustration, one end of the AC power cord is connected to the AC input terminal in the rear board of the power supply. Connect the fire wire, zero line and ground to the corresponding terminal of the device.
2. Connect the plug on the other end of the power cord to your AC 220V power source. Connect the three terminals brown to line (L), blue to neutral (N), and yellow-green to ground (PE) on the other end of the power cord to your AC distribution panel.

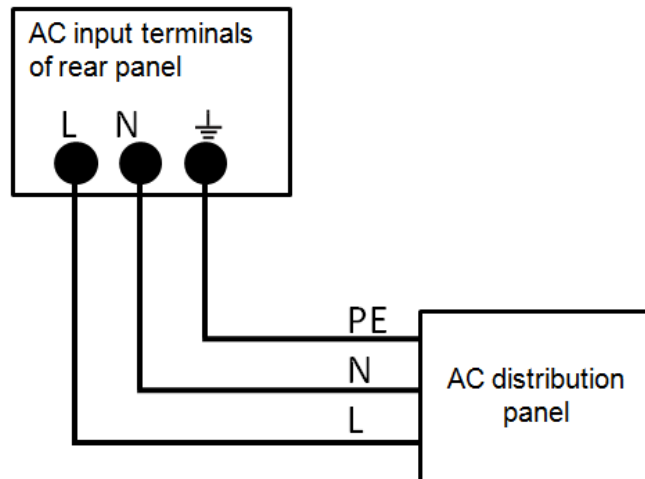

- IT6542C to IT6547C series power supply provides the standard power cords as below.

This series power supplies consist of three power supply units. ITECH provides a tailor-made power lines, making it convenient to connect the power supply to the three-phase distribution box(380V).

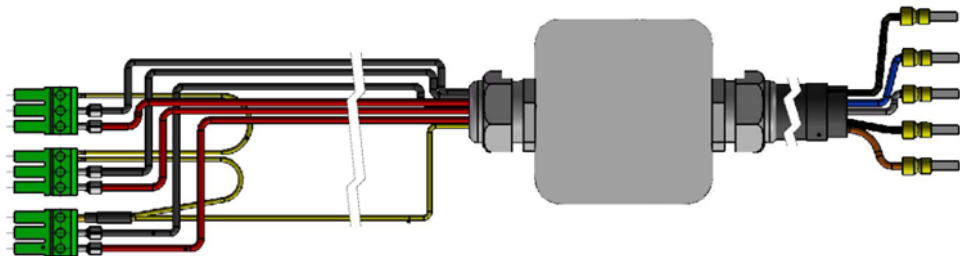

Connecting method:

1. See the below illustration, one end of the AC power cord is connected to the AC input terminal in the rear board of the power supply. And directly insert the green terminals to AC input terminals, respectively.
2. The other end of the power cord is converted to cables of three-phase five-wire. Connect the five terminals to your AC 380V power source. And gray to line (L1), brown to line (L2), black to line (L3), blue to neutral (N), and yellow to protective ground (PE).

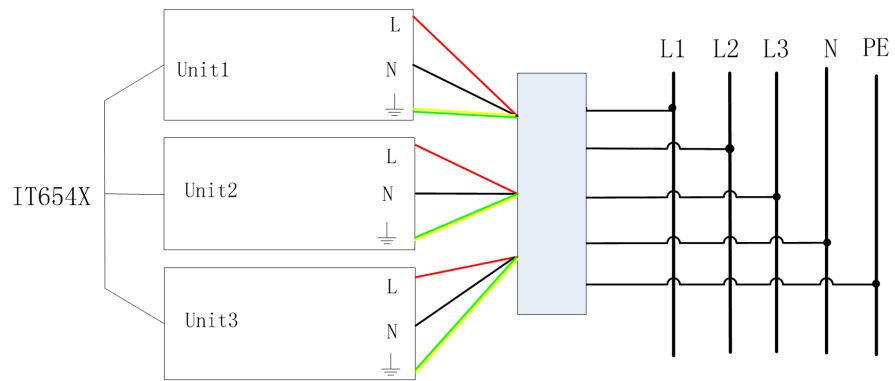

- IT6552C to IT6597Cseries power supply connects the end of power cords with cabinet.

User connects the other end of power cord to AC distribution panel. The power supply AC input connecting as follows:

Connect the five terminals brown to line (L1), black to line (L2), gray to line (L3), blue to neutral (N), and yellow to ground (G) on the other end of the power cord to your AC distribution panel.

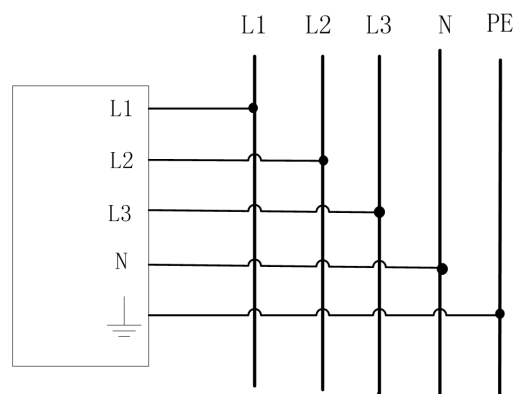

1.4 Connecting the Device Under Test (DUT)

Precautions

To prevent electric shock and damage to the instrument, observe the following precautions.

WARNING

- Before connecting test cables, be sure to switch off the power supply. Power switch is in Off position, otherwise touching the output terminals on the rear panel may result in personal injury or death due to electric shock.
- To avoid electrical shock, before testing, please make sure the rating values of the testing lines, and do not measure the current that higher than the rating value. All test lines shall be capable of withstanding the maximum short circuit output current of the power supply without causing overheat.
- If several loads are provided, each pair of load wires shall safely withstand the rated short circuit output current of the power supply under full load.
- To avoid battery short circuit, be sure to check that the test line end is not connected when connecting or disassembling the test line. When the test line end is connected with battery, short circuit may cause severe accident.
- Always use test lines provided by ITECH to connect the equipment. If test lines from other factories are used, please check that the test line can withstand maximum current.
- During wiring, check that the anode and cathode of the test lines are properly and tightly connected; anode ON and cathode OFF are prohibited.

Specification

Test cables are not standard accessories for the instrument. Please select optional red and black test cables for individual sales based on the maximum current value. For specifications of test cables and maximum current values, refer to the [A.1 Specifications of Red and Black Test Cables](#) in chapter [A Appendix](#) for more information.

Local Measurement

The connection diagram and steps of local sensing are as follows:

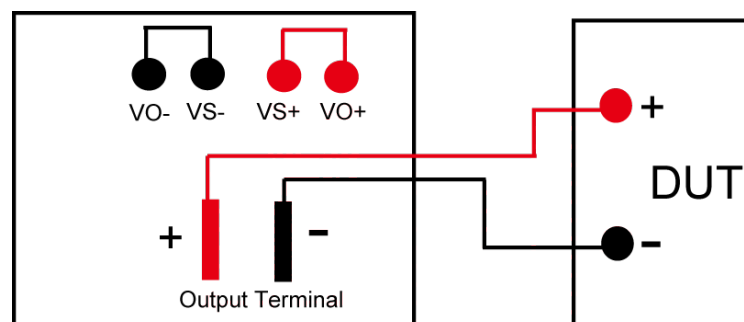

1. Remove the output terminal cover.
2. Connect the V_{0+} and V_{S+} , V_{0-} and V_{S-} for short circuit using the short clips on the back panel of the instrument or electric wire. When using local sense, the remote sense terminal cannot be disconnected.

Note

Do not disconnect the wires if remote sense is not used. Doing so will cause erratic behavior and may damage the power supply under certain conditions

3. Loosen the screws of the output terminals and connect the red and black test cables to the output terminals. Re-tighten the screws.

When maximum current that one test cable can withstand fails to meet the current rated current, use multiple pieces of red and black test cables. For example, the maximum current is 1,200 A, then 4 pieces of 360 A red and black cables are required.

4. Install the output terminal cover.
5. Directly connect the other end of the red and black cables to the DUT.

Remote Sensing

If the tested instrument consumes large current, a large voltage drop will be detected in connection line between tested instrument and power supply terminal. To ensure measurement accuracy, a remote sense measurement terminal V_{S+} and V_{S-} are provided at power supply rear panel to compensate voltage drop lost in wire.

When the power supply is used for measuring battery charge in actual applications, the voltage drop of the wire will lead to voltage inconsistency of both ends and inconsistency of the cutoff voltage of power supply and the actual voltage of battery, resulting in inaccurate measurement.

The sense terminal of rear panel diagram as follows:

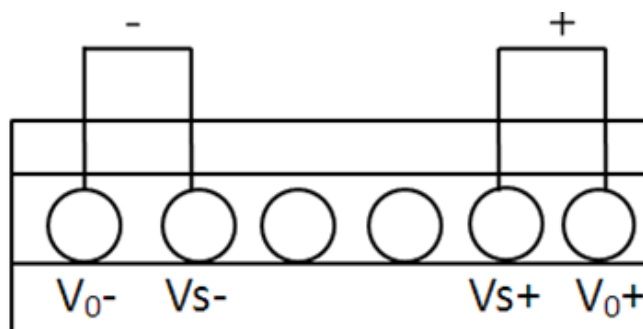

The connection diagram and steps of remote sensing are as follows:

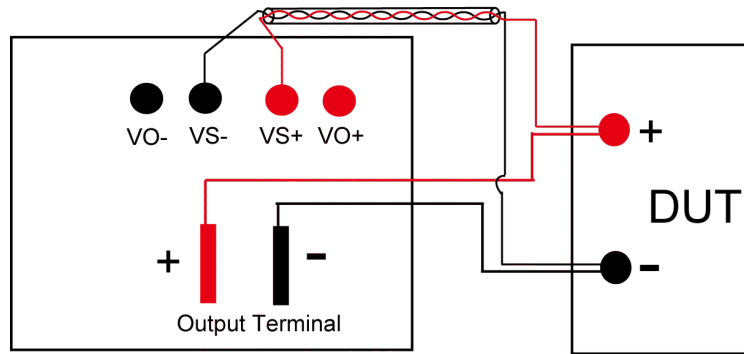

1. Remove the output terminal cover.
2. Disconnect the wires/short clips between Vo+ and Vs+, Vo- and Vs-.
3. Use armored twisted-pair cables to connect the remote sense terminals and the equipment under test.
4. Loosen the screws of the output terminals and connect the red and black test cables to the output terminals. Make proper connection of the chassis ground. Re-tighten the screws.

When maximum current that one test cable can withstand fails to meet the current rated current, use multiple pieces of red and black test cables. For example, the maximum current is 1,200 A, then 4 pieces of 360 A red and black cables are required.

5. Install the output terminal cover, leave the other end of remote sense cables and the red and black cables outside.
6. Connect the other end of the remote sense cables and the red and black cables to the DUT.



Note

To ensure the stability of the system, use armored twisted-pair cables between the remote sense terminals and the equipment under test.

2 Quick Reference

This Chapter will introduce power-on check steps of this series to ensure normal start-up and usage under initialization status of the power. Besides, to facilitate usage, this part also displays the functions of front board, rear board and keyboard keys as well as display functions to a quick view of power appearance, structure and key usage functions before operation.

- ◆ [Brief Introduction](#)
- ◆ [Front Panel Introduction](#)
- ◆ [Keyboard Introduction](#)
- ◆ [Rotary Knob and Coarse/Fine Button Introduction](#)
- ◆ [VFD Indicator Lamps Description](#)
- ◆ [Rear Panel Introduction](#)
- ◆ [Power-on Selftest](#)

2.1 Brief Introduction

IT6500C series power supply is single output high-powered and programmable DC power supply which support CC mode and CV mode. It also has a super wide range of voltage and current applications. The whole series include more than 100 models. The maximum output voltage and current is up to 1000V and 1200A respectively. Users can choose the power supply that fits their testing requirements perfectly.

IT6500C series power supply is featured with:

- Low ripple and low noise
- High Resolution Display
- High visibility vacuum fluorescent display (VFD)
- Built-in internal electronic load and also used as external load
- Working with power dissipater unit, expanding load ability up to 300%
- Two-quadrant current output, fast switching between quadrants, and seamless switching[®], suitable for battery rapid charging/discharging test
- CC & CV Priority Function, Fast curves changing without overshoot
- Flexible and simple programming the parameters of source and load
- Supporting with power supply CV /CC /CP modes and electronic load CC /CP modes
- Programming the output resistance value

- parallel function, active current averaging and expandable power output capacity
- Sequence programming (List mode)
- Built-in DIN40839 / ISO-16750-2 /ISO21848 test sequences
- Solar panel I-V curve simulation function
- Adjustable rising time and falling time speed and independent time setting in various mode
- Fully protections as OVP, OCP, OTP and OPP for source, OCP, OPP and OTP for load, ORVS, UVP and so on
- Match the output reverse protection module to realize the anti-reverse protection (optional)
- Analog Control Interface and remote sense
- Built-in RS232/USB/GPIB /LAN/CAN standard interfaces

Note

1: Seamless switching function can be achieved on the condition that when testing with high-powered battery (12V/120AH). When testing with low-powered battery, the instrument only can achieve fast switching and is unable to realize Seamless switching.

Model	Rated value of source	Rated value of internal load	Height
IT6512C	80V/120A/1800W	50A/150W	2U
IT6513C	200V/60A/1800W	25A/150W	
IT6514C	360V/30A/1800W	12.5A/150W	
IT6515C	500V/20A/1800W	8A/150W	
IT6516C	750V/15A/1800W	5A/150W	
IT6517C	1000V/10/A/1800W	4.2A/150W	
IT6522C	80V/120A/3KW	50A/150W	
IT6523C	200V/60A/3KW	25A/150W	
IT6524C	360V/30A/3KW	12.5A/150W	
IT6525C	500V/20A/3KW	8A/150W	
IT6526C	750V/15A/3KW	5A/150W	
IT6527C	1000V/10A/3KW	4.2A/150W	
IT6532C	80V/240A/6KW	100A/300W	
IT6533C	200V/120A/6KW	50A/300W	
IT6534C	360V/60A/6KW	25A/300W	

Model	Rated value of source	Rated value of internal load	Height
IT6535C	500V/40A/6KW	16A/300W	
IT6536C	750V/30A/6KW	10A/300W	
IT6537C	1000V/20A/6KW	8.4A/300W	
IT6542C	80V/360A/9KW	150A/450W	6U
IT6543C	200V/180A/9KW	75A/450W	
IT6544C	360V/90A/9KW	37.5A/450W	
IT6545C	500V/60A/9KW	24A/450W	
IT6546C	750V/45A/9KW	15A/450W	
IT6547C	1000V/30A/9KW	12.6A/450W	
IT6552C	80V/480A/12KW	200A/600W	
IT6553C	200V/240A/12KW	100A/600W	
IT6554C	360V/120A/12KW	50A/600W	
IT6555C	500V/80A/12KW	32A/600W	
IT6556C	750V/60A/12KW	20A/600W	
IT6557C	1000V/40A/12KW	16.8A/600W	
IT6562C	80V/600A/15KW	250A/750W	
IT6563C	200V/300A/15KW	125A/750W	
IT6564C	360V/150A/15KW	62.5A/750W	
IT6565C	500V/100A/15KW	40A/750W	
IT6566C	750V/75A/15KW	25A/750W	
IT6567C	1000V/50A/15KW	21A/750W	24U
IT6572C	80V/840A/21KW	350A/1050W	
IT6573C	200V/420A/21KW	175A/1050W	
IT6574C	360V/210A/21KW	87.5A/1050W	
IT6575C	500V/140A/21KW	56A/1050W	
IT6576C	750V/105A/21KW	35A/1050W	
IT6577C	1000V/70A/21KW	29.4A/1050W	
IT6582C	80V/960A/24KW	400A/1200W	
IT6583C	200V/480A/24KW	200A/1200W	
IT6584C	360V/240A/24KW	100A/1200W	

Model	Rated value of source	Rated value of internal load	Height
IT6585C	500V/160A/24KW	64A/1200W	
IT6586C	750V/120A/24KW	40A/1200W	
IT6587C	1000V/80A/24KW	33.6A/1200W	
IT6592C	80V/1200A/30KW	500A/1500W	
IT6593C	200V/600A/30KW	250A/1500W	
IT6594C	360V/300A/30KW	125A/1500W	
IT6595C	500V/200A/30KW	80A/1500W	
IT6596C	750V/150A/30KW	50A/1500W	
IT6597C	1000V/100A/30KW	42A/1500W	

2.2 Front Panel Introduction

The 2U models of IT6500C Series power supply have the same front panels. Other models have the same panels as 2U Model. The front panel diagram and function key diagram of 2U Model are as follows.

2U Model

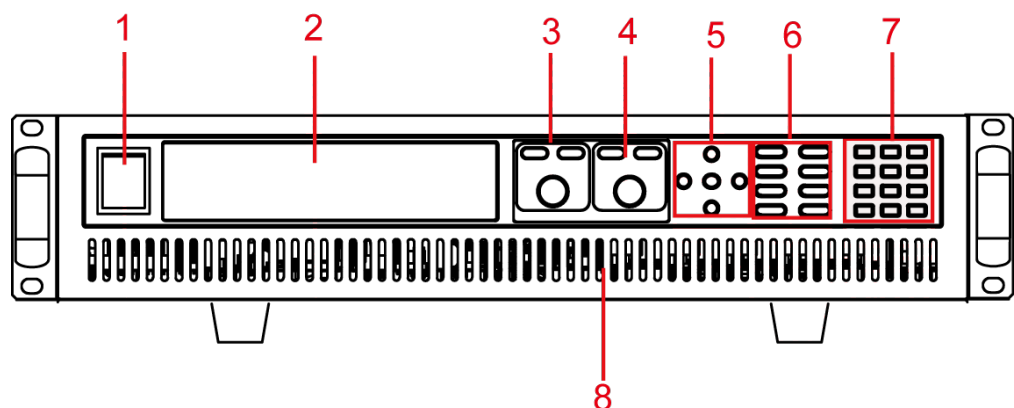

- 1 Power Switch
- 2 VFD Screen
- 3 pulsating knob to control voltage, coarse button, fine button
- 4 pulsating knob to control current, coarse button, fine button

- 5 direction key and OK key
- 6 function keys and composite key
- 7 numeric key and Esc key
- 8 Vent hole

2.3 Keyboard Introduction

IT6500C series power supply different models are same the key function in front board, schematic graph as follow.

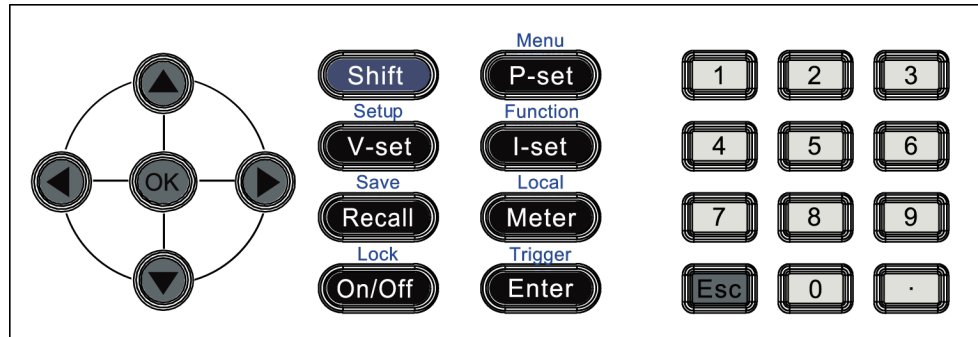

Table 2–1 Detailed description of keys

Key Name	Description
0-9	Numeric button
[Shift]	Composite key
[P-set]	Power setting button, used to set the output power value of power supply
[V-set]	Voltage setting button, used to set the output voltage of power supply
[I-set]	Current setting button, used to set the output current value of power supply
[Recall]	Callback button, used to recall a saved setting parameter
[Meter]	Meter button, used to switch the display between actual value and setting value
[On/Off]	Output on/off button, used to control the output status of power supply
Left and right direction button	Left and right direction button, used to adjust the location of the cursor
Up and down direction button	Up and down direction button, used to select the items of the menu or increase(decrease) the output voltage and current value
[Enter]	Confirm button, used to confirm the setting numbers or functions

Key Name	Description
[Esc]	Return key, used to cancel the setting or return previous menu level
.	Dot

Composite key **[Shift]**, combined with other keys to realize functions marked above keys. The detailed functions are listed as follows.

Keys	Description
[Shift]+[P-set] (Menu)	Enter the system and config menu
[Shift]+[V-set] (Setup)	Enter the setup menu
[Shift]+[I-set] (Function)	Enter the Function menu
[Shift]+[Recall] (Save)	Saves the present settings
[Shift]+[Meter] (Local)	In remote control, press [Shift]+[Meter] (Local) keys to switch the instrument to local control mode
[Shift]+[Enter] (Trigger)	Generate a local trigger signal
[Shift]+[On/Off] (Lock)	Turn the keyboard lock on or off.

2.4 Rotary Knob and Coarse/Fine Button Introduction

IT6500C series power supply is supplied with the voltage adjustment knob and the current adjustment knob, as shown below.

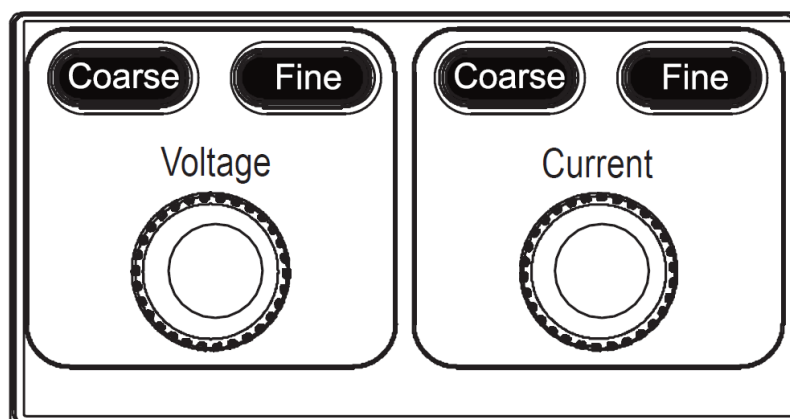

Adjust the voltage or current set value

The voltage knob or the current knob is used to adjust the voltage set value or current set value. Rotate the knob clockwise to increase the set value and anticlockwise to decrease the set value.

- The user can press the **[Coarse]** button and then rotate the knob to adjust the set value in integer bit. The step size of Coarse adjustment is 10. You can press left and right navigation key to move the cursor position.
- The user can press the **[Fine]** button and then rotate the knob to adjust the set value in decimal bit. The step size of Fine adjustment is 0.1. You can press left and right navigation key to move the cursor position.

Select the menu item

The voltage adjustment knob can be used to select the menu item. Press **[Shift]+ [P-set](Menu)** to enter the menu interface and then rotate the voltage adjustment knob to select the menu item from left to right.

2.5 VFD Indicator Lamps Description

IT6500C series power supply VFD indicator lamps description as follows:

Table 2–2 Function VFD indicator lamps description

Flag	Function Description	Flag	Function Description
OFF	Power supply in off mode	CR	None
CV	Power supply in CV mode	Sense	None
CC	Power supply in CC mode	Auto	None
*	Open the keylock function	Addr	When received command successfully, the flag will display 3 seconds.
Rear	“Meter” button in on mode	Rmt	Remote control mode
Shift	using composite function	Error	Error occur

Flag	Function Description	Flag	Function Description
SRQ	Serial request query	Prot	Protections occur
CW	Power supply in CP mode	Trig	Power supply in triggering state

2.6 Rear Panel Introduction

Different models of IT6500C Series power supply have different rear panels. Within 6U models have same rear panels as 2U Model except system bus and AC input terminal. The cabinets have same rear panels. The rear panels are shown as below.

2U Model

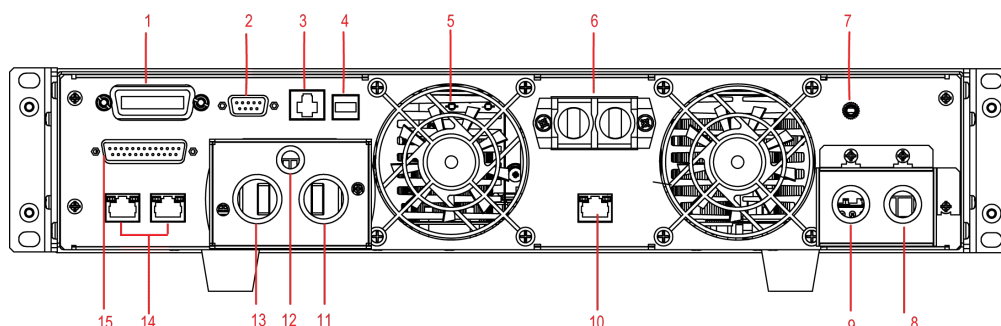

No.	Name	Description
1	GPIB interface	GPIB connector interface. Can be selected to use from front panel menu.
2	RS232 interface	RS232 connector interface. Can be selected to use from front panel menu.
3	LAN interface	LAN connector interface. Can be selected to use from front panel menu.
4	USB interface	USB connector interface. Can be selected to use from front panel menu.
5	Fan	Fan for cooling the device.
6	Power dissipater Connect interface	When using the external load function, used to connect load interface of power dissipater

No.	Name	Description
7	Ground screw	Ground screw for making chassis ground connections
8	AC power input socket and cover	Used to connect AC power to start instrument
9	AC power input terminals for Power Dissipater	Used to connect the AC power input interface of power dissipater to power on the power dissipater.
10	Control interface of load	Used to connect control interface of power dissipater
11	The positive terminal of output	The positive terminal of output for connecting DUT.
12	Sense terminals	Remote sense terminals, used for maximizing measurement accuracy
13	The negative terminal of output	The negative terminal of output for connecting DUT
14	System bus	Used for communication between instruments in parallel operation
15	Analog interface and CAN interface	Analog interface and CAN interface

15U Model

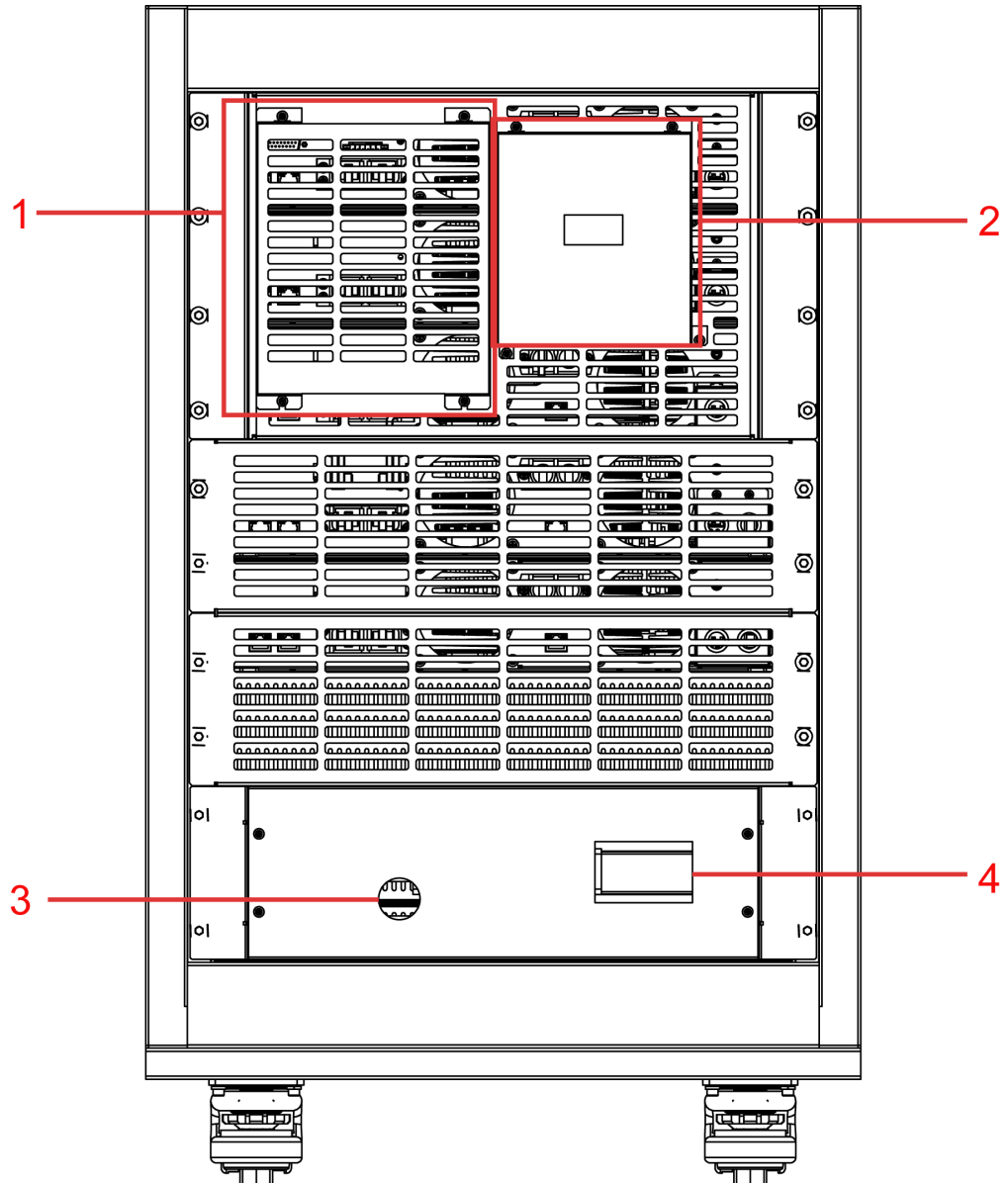

No.	Name	Description
1	Rear panel protection cover	Remove this cover and you will see the communication interfaces on the rear panel of the device.
2	The cover for the power supply output terminals and sense terminals	Remove this cover and you will see the power supply output terminals and sense terminals.

No.	Name	Description
3	AC power input terminals	The AC power input terminals of the instrument.
4	Power switch	The power switch to control the instrument On/Off.

Note

Other models cabinet have the same rear panels as 15U Model except size.

2.7 Power-on Selftest

A successful selftest indicates that the purchased power product meets delivery standards and is available for normal usage.

Before operation, please confirm that you have fully understood the safety instructions.

WARNING

- To avoid burning out, be sure to confirm that power voltage matches with supply voltage.
- The system bus interface is not isolated from the output electrode. After power on, it is not allowed to insert or pull out the bus and terminal matching resistance.

Power Switch Introduction

User can adjust the power switch directly to turn on or turn off the instrument.

The status of Power switch is as follows.



On



Off



On



Off

If the instrument is the cabinet type, the rear panel of the cabinet provides a master power switch. The relationships between the device status and switch status are listed in the following table.

Master switch status	Desperate switch status	Device status
On	On	On
On	Off	Off
Off	On	Off
Off	Off	Off

Selftest steps

Normal selftest procedures:

1. Correctly connect the power cord. Press **Power** key to start up.
2. After selftest, VFD displays the output voltage and current status.

Error Information References

The following error information may occur when an error occurs during Power On self-test:

Error message	Meaning
Eeprom Failure	The EEPROM is damaged.
Mainframe Initialize Lost	The system setting data is lost.
Calibration Data Lost	The calibration data in EEPROM is lost.
Config Data Lost	The latest operation state of the power supply is lost.
NETWORKING...	The parallel operations are abnormal and can't finish the networking.

Exception Handling

If the power supply cannot start normally, please check as below steps.

1. Check whether the power cord is correctly connected and confirm whether the power supply is powered.
2. Check whether the power turn On. Power key is under “I ” “**ON**” status.
3. Check whether the power voltage matches with the supply voltage. Please refer to corresponding specification to select proper AC input.

4. Check whether the terminal resistance (plug) of the system bus is correctly installed, before checking, confirm the alarm information have read.

If no, Please re-install the terminal resistance. For 2U model, insert the terminal resistance at any end of the system bus interface. For other models, insert the terminal resistance to the bus Input of the first power supply system and the bus Output of the last power supply system.

5. When error information prompts at startup, Press **[Esc]** key to see whether present fault state can be cleared. Or, the user can attempt to clear the fault state by restarting the instrument. Do not restart the instrument until it is completely powered down. If not, contact ITECH engineer.

3 Function and Features

This chapter describes in detail the use of the front-panel keys and shows how they are used to accomplish instrument operation. This chapter is divided into the following sections:

- ◆ Setting Voltage
- ◆ Setting Current
- ◆ Setting Power
- ◆ Output On/Off Button
- ◆ Switching Setting Value and Actual Value
- ◆ Switching Local/Remote Mode
- ◆ Key Lock Function
- ◆ Save/Recall Operation
- ◆ System Menu
- ◆ Setup Menu
- ◆ Setting Output Rise Time/Fall Time
- ◆ Protection Function
- ◆ Setting Maximum and Minimum Values
- ◆ Load Function
- ◆ Charge Protection
- ◆ Static Protection Function of Battery
- ◆ Internal Resistance Setting
- ◆ CC/CV Priority
- ◆ LIST Operation
- ◆ PV Simulation
- ◆ Built-in Waveform
- ◆ DC Internal Resistance Measure
- ◆ Parallel Operation
- ◆ Analogue Interface (Enhanced Isolation)

3.1 Setting Voltage

The constant voltage range is from 0V to the maximum voltage value. It is very easy for you to set the constant voltage output. When you press **[V-set]**, this button will be lit and you can set the constant value. You have 3 solutions to set the constant voltage value.

- Directly input through number keys. Input the value you want to set and then please press **[Enter]** or **[OK]** button to confirm.
- Using knob to set value. Press **[V-set]** button, press **[Coarse]** button (- coarse adjustment, change the value in integer bit) or **[Fine]** button (fine adjustment, change the value in decimal bit), and then rotate the knob to set the value.

- Using left and right direction key to set value. Press **[V-set]** button Press **[Coarse]** button (coarse adjustment, change the value in integer bit) or **[Fine]** button (fine adjustment, change the value in decimal bit), move the cursor by left and right keys, then to adjust values through **▲** and **▼**.

3.2 Setting Current

The constant current range is from 0A to the maximum current value. It is very easy for you to set the constant current output. When you press **[I-Set]**, this button will be lit, and you can set the constant current value. You have 3 solutions to set the constant current value.

- Directly input through number keys. Input the value you want to set and then please press **[Enter]** or **[OK]** button to confirm.
- Using knob to set value, Press **[I-set]** button, press **[Coarse]** button (coarse adjustment, change the value in integer bit) or **[Fine]** button (fine adjustment, change the value in decimal bit), and then rotate the knob to set the value.
- Using left and right direction key to set value. Press **[I-set]** button, press **[Coarse]** button (coarse adjustment, change the value in integer bit) or **[Fine]** button (fine adjustment, change the value in decimal bit), move the cursor by left and right keys, then to adjust values through **▲** and **▼**.

3.3 Setting Power

The constant current range is from 0W to the maximum power value. It is very easy for you to set the constant power output. When you press **[P-set]**, this button will be lit. Then you can input the power value by numeric and press **[Enter]** or **[OK]** button to confirm.

3.4 Output On/Off Button

[On/Off] button is used to control the output state of power supply. If **[On/Off]** button is lit, this represents output is open. And in on mode, the indicator lamp (CC/CV/CW) will be lit.

Note

Please ensure that the DC source and product under test have been connected well before you press **[On/Off]** button.

3.5 Switching Setting Value and Actual Value

[Meter] button is used to switch the display between actual value and setting value. When **[Meter]** button is lit, this represents that VFD board display is actual value. Reversely, if **[Meter]** button is dark, VFD board display is corresponding to setting value.

This option allows users to enable an internal fixed timer delay (5 seconds) for the power supply to automatically switch from setting display to measured display. When enabled, if the power supply output state is ON (enabled) and if the display shows setting voltage and current, it will automatically switch to measured voltage and current display after 5 seconds. Factory default is Off status.

3.6 Switching Local/Remote Mode

Power supply provides local and remote modes. The two modes can be switched through communication commands. The default setting is local mode.

- Local mode: use press keys on the power supply front panel to operate.
- Remote mode: connect the power supply with PC, and operate power supply through PC. When it's remote mode, only **[On/Off]**, **[Meter]**, **[Shift]+[Meter]** (Local) work, with all the other panel keys not working. It can be switched to local mode by **[Shift]+[Meter]** (Local) . The power supply's output parameters won't be influenced when mode is switched.

3.7 Key Lock Function

[Shift]+[On/Off] (Lock) button can enable you to lock the front panel buttons, then VFD will display “*”. In keylock mode, all buttons will not work except for **[On/Off]**, **[Meter]** and **[Shift]** buttons. Re-press **[Shift]+[On/Off]** (Lock) button will release the keylock function.

3.8 Save/Recall Operation

IT6500C can enable you to save some frequently-used parameters in nonvolatile memory up to 100 sets, so that you can recall the parameters quickly. The following ways can help you achieve the save and recall operations: by pressing composite button **[Shift] +[Recall]** (Save) button or through command *SAV,*RCL. Save operation should work in with GROUP. Each GROUP can save 10sets, and there are 10 GROUP from 0-9.

Saved contents include , and the and power set value of the load. You can also save the maximum and minimum values of the power supply and load, and select the load type and number of external loads.

- voltage set value of source
- current set value of source
- power set value of source
- maximum and minimum values of source
- current set value of load
- power set of load
- maximum and minimum values of load
- select the load type
- number of external loads

3.8.1 Setting Group Number

To use the save and recall function, firstly, the user need to specify the Group number in the menu. The procedures are as follows.

1. Press composite keys **[Shift]+[P-set]**(Menu) to enter system menu.
2. Select **SYSTEM**, press **[Enter]**.
3. Select **Memory** with Left/Right key and press **[Enter]** to confirm.
4. Press numeric keys to set the Group value: Group=0.
 - Group=0: indicates save (recall) power source parameters in 0-9 sets.
 - Group=1: indicates save (recall) parameters in 10th -19th sets. Under this condition, number “1” represents to save or recall the 10th parameters. Number “2” represents to save or recall the eleventh parameter and so on.
 - Group=2 ~ Group=9 can be understood in the same manner.

3.8.2 Save Operation

Save the parameters to nonvolatile memory. The procedures are as follows.

1. Using composite key **[Shift]+ [Recall]**(Save) to save parameter.
2. The screen prompt "Save data to bank=0", directly input the location number through number keys.
3. Press **[Enter]**, save the preset value into specified memory region.

3.8.3 Recall Operation

Recall the saved parameters from specified memory region.

1. Press **[Recall]** key and recall the saved parameters.
2. The screen prompt "Recall data from bank=0", directly input the location number through number keys.
3. Press **[Enter]**, recall the parameters.

3.9 System Menu

Press the composite key **[Shift]+[P-set]**(Menu) to enter the menu function. At this time, VFD displays optional menus. Scroll the VFD screen with Left/Right key or knob, and the following functions will appear in sequence. Press **[Enter]** to enter function options where the screen display locates. Press **[Esc]** to return to previous menu.

Menu	Menu setting	
SYSTEM	System menu	
	Reset	Restore to factory defaults
	Power-On	Set power on parameters
		Rst(Def) Initialize the system
		Sav0 Remain last shutdown parameters
	Trigger	Set the trigger mode
		Manual(Def) Manual trigger
		Bus Bus trigger
		Ext External trigger

Memory	Work with Recall(Save) button to recall 100 sets saved parameters	
	Group = 0	0: represents 0-9 sets; 1: represents 10-19 sets, by parity of reasoning
Buzzer	Set the buzzer function	
	On(Def)	enable the buzzer function
	Off	disable the buzzer function
Communication	Select the communication interface	
	RS232	Select RS232 communication interface
		Baud rate: 4800/9600/19200/38400/57600/115200
		Data bit: 8
		Parity bit: None/ E (Even parity)/O (Odd parity)
		Stop bit: 1/2
		Addr: Address=1
	USB(Def)	Select USB communication interface
	GPIB	Select GPIB communication interface
		Address= 15 Set the communication address (1-30)
	LAN	Select LAN communication interface
		Info:The information of LAN
		LAN Status
		IP Mode
		IP Addr
		SubNet
		Gateway
		DNS1 (Primary address)
		DNS2 (Secondary address)
		MAC : 8C:C8:F4:40:01:E1
		MDNS Status
		HostName
		HostDesc

		Domain	
		TCPIP::INSTR	
		Socket Port	
		Config: Configure LAN information.	
		IP-Mode: Set IP mode. Auto/Manual	
		Server-Config: Configure the LAN services.	
		MDNS : mDNS service state. Off/On	
		PING : Ping service state. On/Off	
		telnet-scp : telnet service state. On/Off	
		Web: web service state. On/Off	
		VX-11VXI-11 service state. On/Off	
		Raw-socket: RAWSocket service state. On/Off.	
		Restore: Select whether to reset the LAN to the default settings or not. And the settings take effect after restart.	
		Reset: Select whether to confirm the LAN setting or not. And the settings take effect after restart.	
		CAN	Select CAN communication interface
			250K: Baud rate
			Addr: address of power supply
			Prescaler: Prescaler
			BS1 Value: Not settable
		BS2 Value: Not settable	
ReturnMeter	Enables automatic delay to switch display from setting to measured value (meter).		
	Off(Def)	Auto return Meter function disabled.	
	On	Auto return Meter function enabled	

	P-Out	Power whether power supply was on		
		Off(Def)	After power on, the instrument will be in the off state.	
		Last	If output was on prior to turning the power off, the ON state will be resumed after power on.	
CONFIG	Config menu			
	Load-Status		Setting the load status.	
		Load		
			Off (Def)	Load function is switched off.
		On		Internal(Def): internal load function
				External: external load function Ext Load Num: number of external loads.
		Static-Curr		Setting the static current when output is Off
			Off	Turn off static current function (avoid current flow-backward)
		On (Def)	Turn on static current function (clear voltage mantissa)	
	Monitor		10V(Def)	10V monitoring mode options
			5V	5V monitoring mode options
	Ext- Ctrl		External control mode and related parameter setting	
		Voltage (Def)		Voltage setting mode selection
		10V(Def)/5V		10V or 5V setting mode selection. select by left/right key.
		Resistance		Resistance setting mode selection.
		10k/5k		10K or 5K setting mode selection, select by left/right key.
		Off		Disable or enable this function. Select by up/down key.
		On		
Parallel		Parallel mode set up		
	Single	Single mode		
	Master	Act as a master mode		

			Master Mount: Master Mount: total number of instruments in parallel.
		Slave	Act as a slave mode
	Loop-Mode	Control loop setting	
		CV-Loop	CV loop control
			High(Def): High speed
			Low: Low speed
		CC-Loop	CC loop control
			High(Def): High speed
			Low: Low speed
		Priority	Priority setting
			CV(Def): CV priority
			CC: CC priority
	Filter	Set the display filter frequency of the power supply	
		Low	Low speed frequency
		Mid (Def)	Middle speed frequency
		Fast	High speed frequency
Info	Product information		
	Model	Model of power supply	
	Ver	Software version	
	SN	Serial number	
	Last Cal	calibration information for last time	

Note

Press **[Shift]+[P-set]**(Menu) to view the menu items, press **[Esc]** to quit menu operation. Besides, press **[Esc]** button can enable you quit the function operation state.

3.9.1 Restored to Factory Setting(Reset)

This option is used to restore all settings in the system menu to factory setting values.

1. Press composite keys **[Shift]+[P-set]**(Menu) enter to system menu.
2. Select **SYSTEM**, Press **[Enter]**.
3. Select **Reset**, Press **[Enter]**key, restore to factory setting values

The default value for system menu as follows.

Menu Parameter	Default Value
Power-On	Rst(Def)
Trigger	Manual(Def)
Memory	Group = 0
Buzzer	On(Def)
Communication	USB(Def)
ReturnMeter	Off(Def)
P-Out	Off(Def)
Load	Off (Def)
Static-Curr	On (Def)
Monitor	10V(Def)
Ext- Ctrl	Voltage (Def) /10V(Def)
Parallel	Single
Loop-Mode	
CV-Loop	High(Def)
CC-Loop	High(Def)
Priority	CV(Def)
Filter	Mid (Def)

3.9.2 Power On Parameter(Power-on)

When the power-on parameter is set as Rst, at each time of power on, the set parameters of the power supply will be 0V, 0.5A (The current set value of different models are different.) and the power rated value. The setting parameter of load will be internal load rated value.. The parameter setting values under Setup and Function menus will also be restored to initial values.

Rst will not initialize the system setting and configuration setting. If Sav0 is selected, the parameters will be all setting values at the time of last power-off, including output and inputsetting values of the power supply and load.

3.9.3 Trigger Mode (Trigger)

Trigger is used for trigger the output of voltage, current and power, and there're three kinds of trigger options: Manual, Bus, and Ext. The default settings is Manual.

1. Press composite keys **[Shift]+[P-set]**(Menu) enter to system menu.
2. Select **SYSTEM**, press **[Enter]** to confirm.
3. Select **Trigger** with Left/Right key and press **[Enter]** to confirm.
4. Select trigger source with Left/Right key and press **[Enter]** to confirm.
 - Manual: the trigger signal will be given by composite keys **[Shift]+[Enter]**(Trigger).
 - Bus: bus trigger mode.
 - Ext: external signal trigger.

3.9.4 Key Sound Set (Buzzer)

This item can set the buzzer state. On option indicates that when you push buttons, the buzzer will sound. Off option indicates that the buzzer function is disabled. Factory default is On option.

1. Press composite keys **[Shift]+[P-set]**(Menu) enter to system menu.
2. Select **SYSTEM**, press **[Enter]** to confirm.
3. Select **Buzzer** with Left/Right key and press **[Enter]** to confirm.
4. Select **On** or **Off**, the buzzer will change state.

3.9.5 Communication Set (Communication)

Under this item, you can set the concrete communication mode. This unit has provided multiple communication interfaces: RS232/USB/GPIB/LAN/CAN. The customer can choose any one according to his demands.

1. Press composite keys **[Shift]+[P-set]**(Menu) enter to system menu.
2. Select **SYSTEM**, press **[Enter]** to confirm.
3. Select **Communication** with Left/Right key and press **[Enter]** to confirm.
4. Select RS-232/USB/GPIB/LAN/CAN , and press **[Enter]** to confirm.

Please ensure the configuration consistency between our instrument and PC, so that you could have a successful communication.

- Select RS-232: The baudrate options of RS232 are 4800, 9600, 19200, 38400, 57600, 115.2K. Data bit is 8bits. Parity bit has three options: NONE, ODD, EVEN.
- Select GPIB: The GPIB are addressable from 1-30.

- Select CAN: The baudrate options are 20K(20K、40K、50K、80K、100K、125K、150K、200K、250K、400K、500K、500K), the address: 1-127
5. After set, press the **[Esc]** to return.

3.9.6 Return to Meter state (Return Meter)

This option allows users to enable an internal fixed timer delay (5 seconds) for the power supply to automatically switch from setting display to measured display. When enabled, if the power supply output state is ON (enabled) and if the display shows setting voltage and current, it will automatically switch to measured voltage and current display after 5 seconds.

1. Press composite keys **[Shift]+[P-set]**(Menu) enter to system menu.
2. Select **SYSTEM**, press **[Enter]** to confirm.
3. Select **ReturnMeter** with Left/Right key and press **[Enter]** to confirm.
4. Select **On** or **Off** with Left/Right key and press **[Enter]** to confirm.

3.9.7 Power On Output State (P-OUT)

This item can set the power on output state. If you select Last item, that indicates the power on output state is the same with output state before this item is set. If you select Off item, unit will automatically in off mode when you power on. Factory default is Off option. And this setting is effected by Power-on, and take effect when the Power-on set to Save0.

1. Press composite keys **[Shift]+[P-set]**(Menu) enter to system menu.
2. Select **SYSTEM**, press **[Enter]** to confirm.
3. Select **P-Out** with Left/Right key and press **[Enter]** to confirm.
4. Select **Last** or **Off** with Left/Right key and press **[Enter]** to confirm.

3.9.8 Setting Filter

This option sets the display filter frequency of the power supply. The filter function of this series of power supply is averaging calculation. The average values of different frequencies are different, as shown below: Low: 2^{16} ; Mid: 2^{14} ; High: 2^8 .

1. Press composite keys **[Shift]+[P-set]**(Menu) enter to system menu.
2. Select **CONFIG**, press **[Enter]** to confirm.
3. Select **Filter** with Left/Right key and press **[Enter]** to confirm.
4. Select **Low**, **Mid** or **Fast** with Left/Right key and press **[Enter]** to confirm.

3.10 Setup Menu

In the configuration menu, the user can configure all parameters related to the power supply and the load as well as resistance setting.

Configuration parameters of the power supply are as follows:

- Voltage/current/power slope
- OVP/OCP/OPP
- Maximum and minimum limits of voltage/current/power

Configuration parameters of the load are as follows:

- Current and power
- Current and power slope
- OCP/OPP
- Maximum and minimum limits of current/power

Setup	Source	Configure menu		
		Slope	Set the source slope	
			V-Rise: voltage rise slope	
			V-Fall: voltage fall slope	
			I-Rise: current rise slope	
			I-Fall: current fall slope	
			P-Rise: power rise slope	
			P-Fall: power fall slope	
		OVP	Over voltage protection of source	
			On(Def)	Enable over voltage protection function
				V: OVP value
				Delay: delay time of protection
			Off	Disable over voltage protection function
		OCP	Over current protection of source	
			On(Def)	Enable over current protection function
				I: OCP value
				Delay: delay time of protection
			Off	Disable over current protection function
		OPP	Over power protection of source	
			On (Def)	Enable over power protection function
			P: OPP value	

	Limit		Delay: delay time of protection	
		Off	Disable over power protection function	
		V-Max	Maximum voltage setting	
		V-Min	Minimum voltage setting	
		I-Max	Maximum current setting	
		I-Min	Minimum current setting	
		P-Max	Maximum power setting	
		P-Min	Minimum power setting	
	Load	P-set	Setting the load power	
		I-set	Setting the load current	
		Slope	Setting the load slope	
			I-Fall: current fall slope	
			I-Rise: current rise slope	
			P-Fall: power fall slope	
			P-Rise: power rise slope	
		OCP	Over current protection of load	
			On(Def)	Enable over current protection function
				I: OCP value
				Delay: delay time of protection
			Off	Disable over current protection function
	OPP	Over power protection of load		
		On (Def)	Enable over power protection function	
			P: OPP value	
			Delay: delay time of protection	
		Off	Disable over power protection function	
	Limit	Set the maximum and minimum value of load		
		I-Max: Maximum load current setting		
		I-Min: Minimum load current setting		
		P-Max: Maximum load power setting		
		P-Min: Minimum load power setting		
	Resistance	Resistance	Output resistance setting	

3.11 Setting Output Rise Time/Fall Time

Rise/fall time is the time taken for one voltage point to rise/fall to the other under the output status is ON. When view the fall time that voltage falls to 0V, set 0V through **[V-set]**. After press **[Enter]** to confirm, voltage will fall based on the set fall time.

This series of power supply is supported the rise and fall times in all modes(-Source: CV, CC, CP, Load: CC, CP) , the range of time is 0.001S to 24H.

1. Press **[Shift] + [V-set]**(Setup) to enter power supply setting screen.
2. Select “**Source**”, press **[Enter]**.

Or, the user can select **Load** to set the load slope.

3. Select **Slope**.

You can set the rise/fall times for voltage, current and power. The unit is second (S). Each setting can be selected through the Up/Down key. Adjust the rise time through the numeric key, Up/Down key or knob. After input, then press **[Enter]** or **[OK]** for confirmation.

- V-Rise/ V-Fall: Voltage rise/fall slope.
- I-Rise/ I-Fall: Current rise/fall slope.
- P-Rise/P-Fall: Power rise/fall slope.



Note

The drop rate of the voltage is affected by the internal load input current. Setting the load input current to the maximum will get the drop rate of the voltage up. Please refer to the Set load input in [3.14 Load Function](#) for more detailed setting.

When CC mode is selected from CC/CV Priority, the two-quadrant current slope is only affected by the hardware and cannot be changed by the setting parameter, but the one-quadrant current slope can be controlled by the setting parameter.

3.12 Protection Function

IT6500C Series provides OVP, OCP, OPP for power supply as well as OCP and OPP for the load. In addition, this power supply also provides OTP, Sense reverse protection, power-down protection and input under-voltage protection. In case of protection, please check fault reason and remove fault. Press the **[Esc]** key to disarm protection status.

OVP

User can enable the over voltage protection function and set the protection value in setup menu, Over Voltage Protection will be triggered when the voltage exceeds the protection value. Many reasons could cause over voltage protection. For example: caused by internal defect, misoperation or too high external voltage.

- The protection value smaller than set value
- Input too high external voltage
- Internal defect

Once the power supply is over voltage protected, will the output be shut down at once, and “Prot” indicator lamp will be lit, and prompt “Over Voltage” will be displayed on VFD screen. Please avoid inputting a external voltage higher than 120% rated value, or the instrument will be damaged. When the power source is in OVP state, you should check the external cause firstly. When the external factors are excluded, please press [On/Off] button. Then the unit could have a output voltage again. If in remote control mode, you should clear the OVP state, then could you open the output by OUTP ON command.

Set the OVP voltage value as follows:

1. Press composite keys **[Shift]+[V-set]**(Setup) enter to setup menu.
2. Select **Source**, press **[Enter]** to confirm.
3. Select **OVP** with Left/Right key and press **[Enter]** to confirm.
4. Select **On** to enable the OVP function, and press **[Enter]**.
5. Set the OVP value with numeric key and press **[Enter]** to confirm.
6. Set the OVP delay time with numeric key, the range of delay time is 0.001S to 10.00S.
7. Press **[Esc]** to exit menu setting.

OCP

User can enable the over current protection function and set the protection value in setup menu, Over Current Protection will be triggered when the current in circuit exceeds the protection value. Once the power supply is over voltage protected, will the output be shut down at once, and “Prot” indicator lamp will be lit, and prompt “Over Current” or “LOAD Over Current” will be displayed on VFD screen. At same time, the beeper will be on.

When the set value of current smaller than OCP value, the current set value limit the output current value to protect the instrument. This series power supply can set the OCP function for source and load separately.

Set the OCP current value as follows:

1. Press the composite key **[Shift]+[V-set]**(Setup) to enter the setup Menu.
2. Select **Source** in the menu and press **[Enter]** for confirmation.
Or, the user can select **Load** to set the load OCP.
3. Select **OCP** with Left/Right key and press **[Enter]** for confirmation.
4. Select **On** to enable OCP function and press **[Enter]**.
5. Set OCP current value with numeric key and press **[Enter]** for confirmation.
6. Set OCP delay time with numeric key and press **[Enter]** for confirmation.
The range of delay time is 0.001S to 10.00S.
7. Press **[Esc]** to exit menu setting.

OPP

OPP is a protection measure taken when the actual power exceeds the rated power of the power supply. Under OPP, the power supply output will be switched off and VFD indicator “Prot” will be lighted on. In addition, the VFD display screen will display “Over Power” or “Load Over Power”.

This series of power supply can set OPP function for source and load separately.

Set the OPP power value as follows:

1. Press the composite key **[Shift]+ [V-set]**(Setup) to enter the setup Menu.
2. Select **Source** in the menu and press **[Enter]** for confirmation.
Or, the user can select **Load** to set the load OPP.
3. Select **OPP** with Left/Right key and press **[Enter]** for confirmation.
4. Select **On** to enable OPP function and press **[Enter]**.
5. Set OPP power value with numeric key and press **[Enter]** for confirmation.
6. Set OPP delay time with numeric key and press **[Enter]** for confirmation.
The range of delay time is 0.001S to 10.00S.
7. Press **[Esc]** to exit menu setting.

Over-temperature protection

When internal power device of instrument is higher than about 90 °C, the instrument is under temperature protection. At this time, the instrument will automatically be OFF and VFD will display “Over Temperature”.

Power down protection

With power-down protection, when the instrument power supply is switched off and the instrument detects power-down status, the instrument will immediately execute output switch-off and the instrument interface will display “power-down”.

Under Voltage Protection

When internal voltage is low due to internal fault or when AC input voltage is low, the instrument will initiate the under-voltage protection. Or when 110V AC power supply is connected, the instrument output function is limited. When the set output power exceeds limit value, the instrument will also initiate under-voltage protection status. In the case of under-voltage protection, the instrument interface will prompt “Under Voltage Prot”.

Sense Reverse Protection

The instrument defaults to provide sense reverse protection. When the output state is ON and the difference between output terminal voltage and sense remote voltage exceeds the specified voltage, sense reverse protection will be enabled after 500ms. The power supply output will be immediately switched to Off and the buzzer will sound if the sense terminals are reversed. The display screen will display “Sense Reverse Prot”. Press **[Esc]** to clean the protection.

When the power source is in Sense Reverse Protection state, you should check the whether the polarities are connected reversely or not firstly. When the polarities connect correctly, please press **[On/Off]** button. Then the unit could have a output voltage again.

The voltage difference between output terminal and remote sense terminal of each model is not the same. The detailed value is shown in the next table. When the remote sense terminal is connected reversely, the maximum voltage will not exceed the sum of set voltage and the difference voltage.

IT6512C~IT6592C	5V
IT6513C~IT6593C	5V
IT6514C~IT6594C	7V
IT6515C~IT6595C	10V
IT6516C~IT6596C	15V
IT6517C~IT6597C	20V

3.13 Setting Maximum and Minimum Values

The maximum voltage of the power supply ranges from V-min to full-rated output voltage. Press the composite key **[Shift] + [V-set]** (Setup) to enter the Configuring Menu for setting maximum and minimum values of power supply voltage, current and power , maximum and minimum values of load current and power. When limit setting is finished, the voltage, current and power setting values can only be set within the maximum and minimum limits.



Note

Function and external analog programming are not limited by Limit.

Set the maximum and minimum voltages as follows:

1. Press the composite key **[Shift]+[V-set]**(Setup) to enter the Configuring Menu.
2. Select **Source** in the menu and press **[Enter]** for confirmation.
Or, the user can select “Load” to set the load Limit. For load, you can only set the maximum and minimum limits of the current and power.
3. Select **Limit** with Left/Right key and press **[Enter]** for confirmation.
4. Set the V-Max with numeric key and press **[Enter]**.
5. Set the V-Min with numeric key and press **[Enter]** for confirmation.
Or, select the maximum/minimum current or power with Arrow key.
6. Set maximum/minimum current or power with numeric key or press **[Esc]** to exit menu setting.

After the maximum/minimum voltage is set, the output voltage can only be set within this range. Vmax factory setting is the rated output voltage of corresponding model of the power supply. V-Min is 0V.

3.14 Load Function

The load function in this series of power supply extends the working range of the power supply to make it absorb certain current and power. This is a two-quadrant power supply, which can be switched quickly under current mode of the power supply and the load, so as to enable speedy, continuous and seamless switching between output and absorption current. It can be applied in charge/discharge tests of the battery. The load is divided into internal load and external load based on discharging capacity. For detailed specifications, refer to Technical Specification Parameters.

Internal load

When the load function is initiated, the system is defaulted to be in internal load mode. By default, the default value of power is power rated values. The default value of current is small and different for each model. Please refer to the actual value.

The user can turn on load function in the Configuration Menu. Detailed operations are as follows.

1. Press **[Shift]+ [P-set]**(Menu) to enter the Menu operation.
2. Press the Right key to select **CONFIG** in the Menu to enter the Menu operation and select **Load-Status**. Press **[OK]/[Enter]** for confirmation and select the **Load** to set the load status.
3. The user can select **On** through Arrow key to turn on the load function.

On: the current load function is on. The user can select On or Off to turn on or off the load function through Up/Down key. When the load is on, you need to select internal load or external load. The instrument defaults to internal load.

Internal: the current load is internal load. The user can select Internal (- internal load) or External (external load) through Up/Down key.

External load

In using external load function, the user needs to parallel the IT-E500 Series power dissipater. When using external load function, you need to set the number of power dissipaters so that the user interface can automatically zoom the range. The power dissipater can be paralleled to extend or discharge power but not current. Maximum average discharge power \leq maximum output voltage \times maximum discharge current.

1. Press **[Shift]+[P-set]** (Menu) to enter the Menu operation.
2. Press the Right key to select **CONFIG** in the Menu to enter the Menu operation and select **Load-Status**. Press **[OK]/[Enter]** for confirmation and and select the **Load**to set the load status.
3. The user can select **On** through Arrow key to turn on the load function.

On: the current load function is on. The user can select On or Off to turn on or off the load function through Up/Down key.

4. Select current load as **External** and press **[Enter]** for confirmation.
5. Press the number key to set the number of power dissipaters in parallel, for example Num = 1. When external load function is selected, you need to set

the number of external power dissipaters in parallel. This number is multiple extended of power instead of total number of power dissipaters. Setting range is 1-3. The load power of each instrument can be extended by 300%.

Parallel connection of power dissipaters

IT-E500 Series power dissipater is an accessory provided by ITECH for this power supply. Each IT-E500 power dissipater can provide discharge capacity up to 3KW and supports parallel connection of several power dissipaters. Each 2U power supply can be paralleled to 3 power dissipaters at most. You can select the power dissipater based on power supply model. For detailed description of the power dissipater, refer to IT-E500 Series User Manual.

The wiring method for three parallel power dissipaters is as shown below.

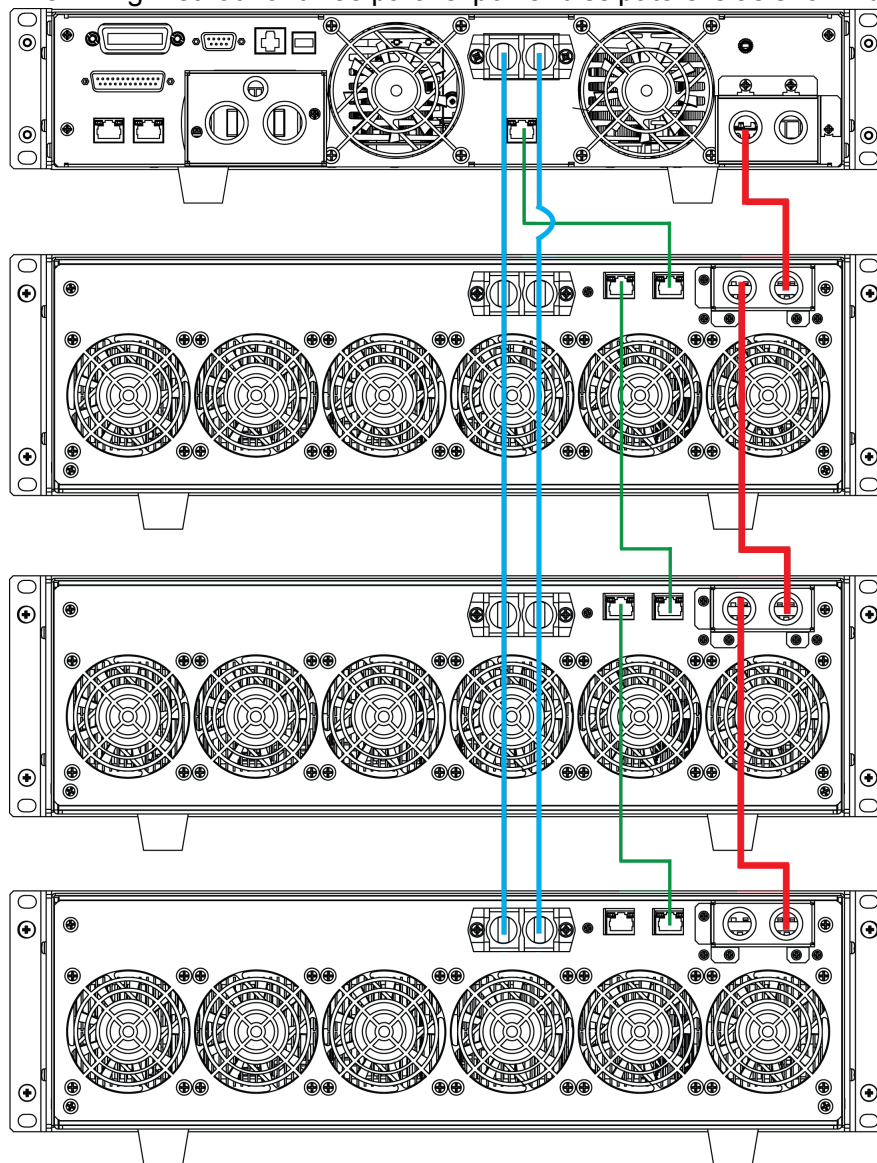

Wiring instruction:

- Connect the external load's connection terminal of IT6500C Series power supply to the load input interface of IT-E500 Series power dissipater. Connections of other power dissipaters are as shown in blue lines in the figure.
- Connect the external load AC input interface OUTPUT (LOAD) of IT6500C Series power supply to the AC input interface of the power dissipater. AC input connections of other power dissipaters are as shown in red lines in the figure. Please pay attention to corresponding L/N/G terminals.
- Connect the external load control interface of IT6500C Series power supply to the control interface of IT-E500 Series power dissipater. Connections of other power dissipaters are as shown in green lines in the figure.

Set load input

When using load function, the user can set load current, power and slope as well as OCP, OPP, etc.

In internal load mode, the value of load power is defaulted to rated value, and the value of current is defaulted to a small value. In external load mode, the values of load power and current are defaulted to zero.



Note

When the number of the power dissipater for external load changes, the load limit value needs to be changes manually.

Set the load input current and input power in Setup menu. Details about load input current/power are as shown below.

1. Press **[Shift]+ [V-set]**(Setup) to enter the Menu operation. The interface displays information as follows:
2. Select **Load** to set parameters related to the load.

```
LOAD
P-set   I-set   Slope   OCP
```

 - Select **P-set** to set the input power value.
 - Select **I-set** to set input current value.
3. Press the Number key or use Knob to directly set the power or current value.

3.15 Charge Protection

This power supply is applicable to battery charge test and provides charge protection during battery charge test. Even when the internal load is activated, the UUT will not be discharged. During charge protection, the power supply switches off output as follows.

1. Power output is switched off (On/Off key is lighted off) and power supply will stop output.
2. The internal load discharges the capacity energy at power output through a small current.
 - When capacity energy discharge of the power supply is normal, it means that no energy storage device is found. Continue to discharge the current to 0V. To end.
 - When abnormal capacity energy discharge is detected, the UUT connected at the output terminal is a battery or other energy storage devices. To step3.
3. The power supply will automatically adjust the internal load discharge current to 0 and stop discharge.

This protection function forbids UUT discharge to guarantee device safety. It also avoids insufficient charge during battery charge test.

3.16 Static Protection Function of Battery

The power supply is designed with the battery protection function in static state (when the output is off). If the DUT is the energy storage device like battery, the power supply will prevent battery from consumption.

1. Press **[Shift]+[P-set]**(Menu) to enter the system menu. (Menu) .
2. Select **CONFIG**→**Load-Status**→**Load**, enable the internal load. (Default setting is Off status)
3. Press **[Esc]** to exit menu setting.
4. Select **Static-Curr** and turn off static current function when output is Off.

If the DUT is the energy storage device like battery, you need to turn off the static current function. Otherwise, the current of the battery will be consumed and flow backwards to the power supply. The value of the current flowing backwards of different models is not the same. It ranges from 0.1A to 0.5A approximately.

3.17 Internal Resistance Setting

During the simulation of the battery charging/discharging, it's necessary to consider about the internal resistance changes of the battery. For accurate battery simulation test, IT6500C Series power supply provides internal

resistance setting to simulate various kinds of actual working statuses of the battery.

To set internal resistance, follow the methods below.

1. Press the composite key **[Shift]+ [V-set]** to enter the Configuring Menu.
2. Select **Resistance** in the menu and press **[Enter]** for confirmation.
3. Set internal resistance value with number key and press **[Enter]** for confirmation.

3.18 CC/CV Priority

IT6500C Series is innovatively designed with CV/CC priority concept in the industry to solve various strict problems in long-term test applications and to make applications (e.g., speedy or no-overshoot operation of power supply) more flexible. As everyone knows, power supply has two working modes including constant voltage and constant current, which correspond to two inside loops (CV control loop and CC control loop). Traditional power supplies always take CV loop as priority, which are not suitable for circumstances having high requirements on current overshoot. With new CC/CV priority concept in IT6500C, the user can realize CC control loop, response speed of CV control loop and any combination setting of control loops under CC and CV mode through the power supply menu interface to meet diversified field applications. With this function, the user can save a lot of costs as no purchased parts are required.

Example of application circumstance in typical configuration application:

- Strict requirements on current overshoot

Set Priority as CC, CC-Loop as High and CV-Loop as Low. This priority is applicable for circumstances having high current overshoot requirements, like LED lamp, laser test, etc.

Traditional power supply has low priority due to slow CC loop speed and cannot quickly detect and inhibit current overshoot when the current reaches the set current. Through IT6500C menu, you can set the CC control loop to High priority to quickly make the power supply in constant current status so as to inhibit current overshoot at the starting moment.

Waveform characteristics are as shown below. Yellow means output voltage and green means output current.

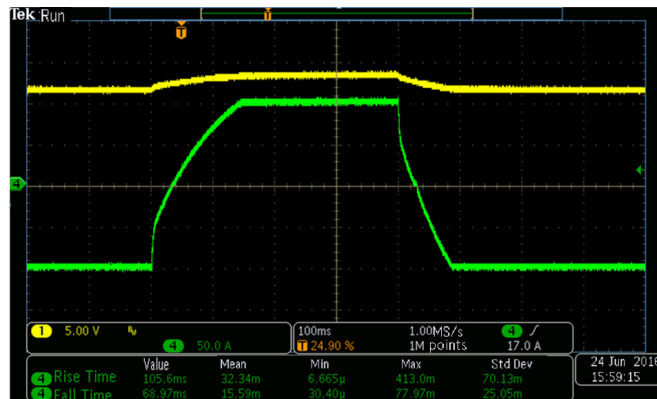

- Start up the over-current range of surge current to quickly set up voltage.

As the input end of power supply module has large capacity, large surge current will generate at starting moment, which will lower the power supply voltage at the input side of DC module. In addition, this will result in CC current limit mode, where low supply voltage will cause under-voltage protection of DC module, making startup fails.

Set Priority as CV, CC-Loop as Low and CV-Loop as High. The voltage is not sensitive to current at phase step and voltage edge can be realized quickly. In addition, this avoids surge current at startup, which may cause CC mode and startup failure.

Waveform characteristics are as shown below. Yellow means output voltage and green means output current.



- Battery charge-discharge, high speed, seamless, and no overshoot

Set Priority as CC, CC-Loop as High and CV-Loop as High to represent CC characteristics entirely. In this way, you can quickly create current and inhibit

current overshoot so as to realize seamless and no-overshoot current switch.

Waveform characteristics are as shown below. Yellow means output voltage and green means output current.

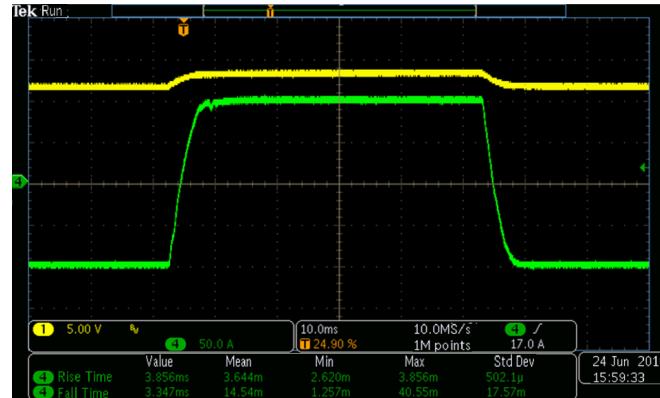

WARNING

When CV mode is selected from CC/CV Priority, the load current value set in List wave file fails and discharge current is the I-set value set in the power supply Setup menu. Pay attention to current value to avoid over-current. For detailed checking and setting methods, refer to [3.14 Load Function](#).

To set loop and CC/CV mode, follow the method below.

1. Press the composite key **[Shift]+[P-set]**(Menu) to enter the Configuring Menu.
2. Select **CONFIG** in the menu and press **[Enter]** for confirmation.
3. Select **Loop-Mode** with Right key and press **[Enter]** for confirmation.
4. Select **CV-Loop** or **CC-Loop** to set the loop response speed.
5. Select **Priority** and set the current priority work mode, which defaults to CV mode.

3.19 LIST Operation

LIST mode comprises 10 files (File1-File10) in total, and each has 10 waves. Each wave has 10 steps. You need to edit the voltage, current, load current, pulse width and rise/fall slope of each step. Each wave can set repetition, so does each list file. Ten wave files can be linked in sequence under one list.

Relationship between List file and wave file is shown below.

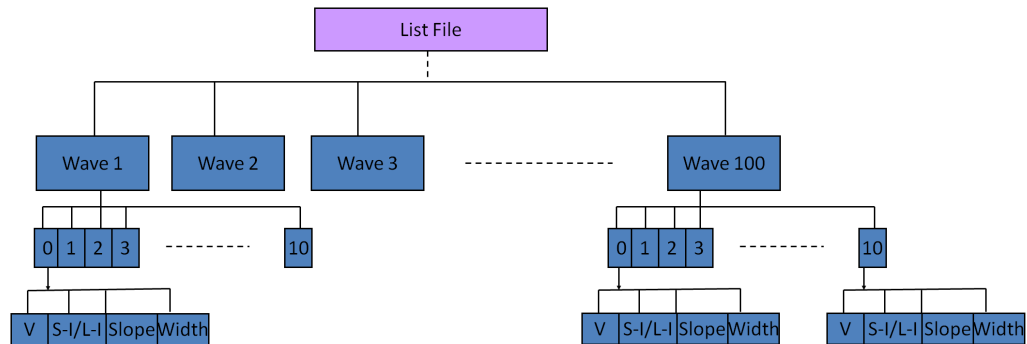

List file can select any one from 100 waves. Each List file can select 10 wave files at most and combine them into a List file based on sequence.

Each wave file has ten steps. The List file can select the wave file and set the count of repetitions to be executed.

List function menu is as follows.

List	List function menu	
	On/Off	List function switch
	Recall	List file recall
		Recall File Name: Need to recall list file number.
	EditFile	List file edit
		Repeat: count of List file repetitions (0-65535)
		Wave Count: total count of waves contained in this List file. (1-10)
		1st Wave Select: number of the first wave selected
		1st Wave Repeat: count of repetitions of the first wave selected (0-65535)
		Yes/No: save to the file or not
	EditWave	Wave file edit
		Recall Wave: Need to recall Wave file number.
		Step Count: total count of steps contained in the Wave file (1-10)

		Step1 Voltage: Voltage setting of step 1 (0-Vmax)
		Step1 Current: Current setting of step 1 (0-Imax)
		Step1 LoadCurr: Load current setting of step 1 (0-Imax(load))
		Step1 Width: Width setting of step 1 (0s-24h)
		Step1 Slope: Slope setting of step 1 (0s-24h)
		Save to Wave: save to the Wave file

Wave edit and List edit have no order of priority.

Editing Wave

List file can arrange and link several Wave files. The user can pre-edit several Wave files and select edited wave file that meets requirements during usage. In this series of power supply, at most 100 wave files can be edited.

Take an example for 3 steps, the steps of editing Wave file are as follows:

1. Press **[Shift]+I-set**(Function) to enter List operation.
2. Press the Right key to select **EditWave** from the menu, and press **[Enter]** to confirm.
3. Press numeric key to input the number of Wave file under edit, where Recall Wave= 01, and press **[Enter]** to confirm.

```
Recall Wave : 01
```

4. Press numeric key to input total count of steps for the current Wave file, where Step Count=03, and press **[Enter]** to confirm.

```
Step Count=03
```

5. Press the numeric key to set the voltage, current, load current, slope and width of the Wave step 1 in sequence.

```
Step1 Voltage = 1V
```

```
Step1 Current = 1A
```

```
Step1 LoadCurr=1A
```

```
Step1 Width = 1s
```

```
Step1 Slope = 0.1s
```

Note

When CV mode is selected from CC/CV Priority, the load current value set in List wave file fails and discharge current is the I-set value set in the power supply Setup menu. Pay attention to current value to avoid over-current. For detailed checking and setting methods, refer to [3.14 Load Function](#).

When CC mode is selected from CC/CV Priority, the two-quadrant current slope is only affected by the hardware and cannot be changed by the setting parameter, but the one-quadrant current slope can be controlled by the setting parameter.

6. After editing the above parameters in step 1, continue to edit the same parameters for step 2 and step 3. Count of steps is up to customer requirements. At most 10 steps can be edited. The edited **Step Count** shall be consistent with the one defined by the customer.
7. Select **Save to Wave** to save, and press **[Enter]** for confirmation. Select Yes. After editing, select Yes or No. Select **Yes** to save to the Wave file. Select **No** not to save and return back to the List Setting screen.

Editing List File

List file editing means to arrange and link several Waves in certain sequence.

Take an example for 3 wave files, the steps of editing list file are as follows:

1. Press **[Shift]+[I-set]**(Function) to enter List operation.
2. Press the Right key to select **EditFile** from the menu.
3. Press the numeric key to set the count of repetitions in executing this List file. For example, if there are 2 repetitions, Repeat = 2.

Repeat = 2

4. Press the numeric key to set the count of Waves contained in this List. For example.

Wave Count = 3

5. Press the numeric key to input the number and count of repetitions of the first Wave selected.

1st Wave Select = 02

1st Wave Repeat = 1

6. Press the numeric key to input the number and count of repetitions of the second Wave selected.

2nd Wave Select = 02

2nd Wave Repeat = 1

7. Select the Wave arranged and count of repetitions in sequence. The Wave count and arrangement sequence of each List file can be defined by the customer based on requirements. A List file can link 10 Waves at most. The edited Wave count shall be consistent with the one defined by the customer.
8. Select **Save to File = 01** to save. Press **[Esc]** not to save and return back to the List Setting screen.

Run List File

After editing List file, the user needs to set the trigger mode and run List function. Return to the main screen for triggering. Detailed steps are as follows:

- Before starting up List function, please set trigger mode first. See Section [3.9.3 Trigger Mode](#) .
- Trigger the List file as follows
 1. Press **[Shift]+ [I-set]**(Function) to enter List operation.
 2. Press the Right key to select **Recall** from the menu, and press **[Enter]** for confirmation.

```
Recall File Name = 01
```
 3. Press Arrow key to select **Off**, and press **[Enter]** for confirmation. Then, **Off** is changed to **On**. List function is switched on.

```
On Recall EditFile EditWave
```
 4. Press **[Esc]** back to the main screen. Press **[On/Off]** to switch on power output. The screen is displayed as follows.

```
0.00V    0.00A
0.0W     List
```
 5. Press **[Shift]+[Enter]**(Trigger) for triggering. The VFD Trig is lighted up.



Note

If **On Recall EditFile EditWave** is displayed under LIST MENU or the external analog control function is switched on, neither List nor Wave file editing is accessible. In this case, change **On Recall EditFile EditWave** to **Off Recall EditFile EditWave** before operation.

3.20 PV Simulation

The PV array/module/cell is a device that converts from light energy to electric energy. It is made by a simple semiconductor PN junction that the major output

characteristic is that there's only one maximum power point (MPP) at certain sunlight intensity. The PV inverter is designed to track this point to harvest maximum energy that is generated by the PV array. Therefore, all the PV inverters have the maximum power point tracking (MPPT) mechanism built-in, and it is very important to test the efficiency of this MPPT.

PV array VI curve here:

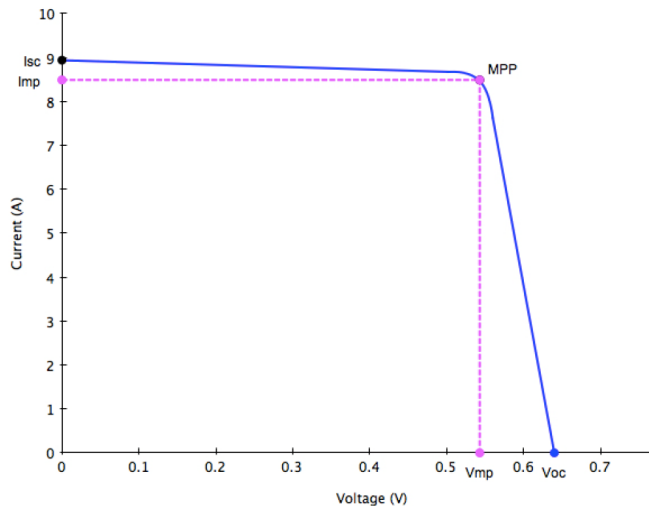

Editing Array VI Curve

A PV (photovoltaic) array simulator is built-in the PVS series power supply to output the PV's V/I (voltage/current) curve for PV inverter testing. User can set up to 100 curves by 2 major parameters of the PV array (Pmp and Vmp) and one 4096-point V/I table.

The menu as below:

PV-SIM	PV Simulation		
	On/Off	Enable/Disable the PV simulation function , Indicates to enter the PV-SIM function mode and wait for the trigger to run the currently selected PV curve file.	
	Vmax	Used to limit the maximum value of the output voltage. Even if the output voltage is set in the PV curve, the output is still limited by the settings here.	
	Static	Static PV curve setting.	
		Curve	Open or edit a fixed format PV curve.
		Recall	Select a PV curve.

				Recall Curve=1	Set the name of the PV curve file and recall the PV file stored inside the instrument.
			Edit-Curve	Edit a PV curve.	
				Pmp	Set the maximum power.
				Vmp	Set the maximum power voltage.
				SANDIA	<ul style="list-style-type: none"> • TF : Thin-Film • SCMC : Standard Crystalline or Multi-crystalline • HEC : High-efficiency Crystalline
				E-N50530	<ul style="list-style-type: none"> • TF: Thin-Film • cSi
		User-defined	User defined the PV curve table		
			Voc	Set the open-circuit voltage value.	
			Imp	Set the maximum power current value.	
			Vmp	Set the maximum power voltage value.	
			Isc	Set the short-circuit current value.	
	Table	Indicates a user-defined 4096-point I-V data table. This menu item is reserved and can only be used in SAS software sold separately. This function cannot be used in the VFD screen.			

- To edit internal curve, follow the operation steps below:
 1. Press **[Shift]+ [I-set]** (Function) to enter the Menu operation.
 2. Select **PV-SIM** with Left/Right key and press **[Enter]** for confirmation.
 3. Select **Static** with Left/Right key and press **[Enter]** for confirmation.
 You can enter Static to edit the curve only when the photovoltaic curve is Off. Otherwise, you cannot edit the photovoltaic curve.

4. Select the instrument as simulation of one photovoltaic curve based on 2 parameters. Select **EditCurve** to enter editing mode.

Under this mode, the user needs to define the curve number, maximum power and maximum power voltage. For detailed parameter description, refer to internal waveform menu description.

- The operation steps to set a curve by self-defining a I-V table with 4096 points are as follows.

The user can edit a curve of output current and voltage by PC software. When the data table is imported to the power supply, the power supply samples the output current and get the current value and voltage value currently by querying the data table to define the I-V curve.

Run the photovoltaic curve

After set of desired curve, run the photovoltaic analog. The power supply will change the output voltage and current at 1ms interval to keep the voltage and current above V/I curve. This speed is enough to meet most trace mechanisms at maximum power point.

You can set and run local edit curves locally or remotely.

The user-defined 4096-point V/I datasheet can only be set via remote PC, but can be run locally or remotely.

1. Press **[Shift]+ [I-set]**(Function) to enter the Menu operation.
2. Select **PV-SIM** with Left/Right key and press **[Enter]** for confirmation.
3. Select **On** or **Off**. Press **[Enter]** to switch the current curve status as On.
4. Press **[Esc]** to exit the main interface.
5. Press **[On/Off]** to turn on the power supply output. The power supply will output corresponding voltage based on the current value.

3.21 Built-in Waveform

IT6500C models have built in DIN40839 waveform, ISO-16750-2 waveform and ISO21848 Provide for user to execute the test directly.

Menu as below:

Road-Vehicles	Vehicle waveform		
	DIN40839	Evaluation of automotive starting waveform	
		12V	Select the 12V waveform
		24V	Select the 24V waveform

	User-defined	User defined waveform	
	Off	Disable/Enable the automotive starting waveform function.	
	On		
ISO16750-2	simulate the waveform to verify the anti-interference performance of the automotive electronics' products.		
	Short-Drop	This test simulates the effect when a conventional fuse element melts in another circuit	
		12V	Select 12V or 24V waveform
		24V	
		Off	Enable or Disable the Short voltage drop function.
		On	
	Reset-Test	This test verifies the reset behavior of the DUT at different voltage drops. This test is applicable to equipment with reset function	
		Usmin...	The minimum supply voltage Usmin (Usmin≤80V)
		Off	Enable/Disable this function
		On	
	Starting-Profile	This test verifies the behavior of a DUT during and after cranking.	
		12V	Select 12V or 24V test system
		24V	
			Set the levels/voltages/duration of starting profile
			The levels of 12V: 1-4
		1	The levels of 24V: 1-3
		Off	Enable/Disable this function
		On	
	Load-Dump	Load dump curve	

			Test A	select centralized load dump Unsuppression
			Test B	select centralized load dump suppression
			Off	Turn off load dump waveform
			On	Turn on load dump waveform
			12V	Select 12V or 24V voltage system
			24V	
			Td	Pulse width
			Un	Peak voltage
			Us	clamping voltage
	ISO21848	Simulate the curve of “Electrical and electronic equipment for a supply voltage of 42 V — Electrical loads”		
		Umax,dyn	Umax,dyn Test pulse	
			Off	Turn on / off Umax, dyn test pulse
			On	
		Momentary-Drop	Transit Voltage drop	
			Off	Turn on / off transit Voltage drop wave
			On	
		Reset	Reset test supply Voltage	
			Ulow	Set supply Voltage
			Off	Turn on /off rest test function
			On	
		Start	Startup pulse	
			Off	Turn on /off startup pulse
			On	

	SAEJ1113-11	SAEJ1113-11 waveform protocol		
	Test 2B	Transient from DC motors acting as generators after ignition switch OFF		
		Off	Turn on/off this function	
		On		
		12V	Select 12V or 24V voltage system	
		24V		
		Td	Test pulse width	
		Test 4	Starter motor engagement disturbance pulse	
			Off	Turn on/off this function
			On	
			12V	Select 12V or 24V voltage system
	24V			
	Vs		Refer to the figure	
	Va		-	
	T7		-	
	T9		-	
	T11		-	
	Test 5	Load dump waveform		
		Test A	select centralized load dump Unsuppression	
		Test B	select centralized load dump suppression	
Off		Turn on/off load dump waveform		
On				
12V		Select 12V or 24V voltage system		
24V				
Td		Pulse width		
Un	Peak voltage			

		Us	clamping voltage
	LV124	LV124 waveform protocol	
	E-02	Transient overvoltage test waveform	
		Off	Turn on / off this function
		On	
	E-04	LV124 E-04	Jump start test waveform
		Off	Turn on/off this function
		On	
	E-05	LV124 E-05	Load dump test waveform
		Off	Turn on/off this function
		On	
	E-07	LV124 E-07	Slow decrease and increase of the supply voltage test waveform
		Ubmax	Start voltage
		Ubmin	Holding voltage
		Ubmin Holding Time	Holding time at Ubmin
		Off	Turn on/off this function
		On	
	E-08	LV124 E-08	Slow decrease, quick increase of the supply voltage test waveform
		Ubmax	Start voltage
		Ubmin	Holding voltage
		Ubmin Holding Time	Holding time at Ubmin
		Off	Turn on/off this function
		On	

		E-09	LV124 E-09	Reset behavior test waveform
			Ubmin	Holding voltage
			Off	Turn on/off this function
			On	
		E-11	LV124 E-11	Start pulses
			Cold-Start	Cold start
				Normal: normal pulse
				Severe: severe pulse
			Warm-Start	Warm start
			Off	Turn on/off this function
			On	
		E-12	LV124 E-12	Voltage curve with intelligent generator control
			ΔU	Voltage drop between DUT and battery terminals
			Off	Turn on/off this function
			On	

3.21.1 Automotive Starting Waveform

IT6500C models have built in DIN40839 waveform. This test verifies the behavior of a DUT during and after cranking. This waveform can reproduce the voltage curve for automotive power network confirms to DIN 40839 standard, thus facilitating quick call by customers.

For automotive startup voltage waveform, the startup voltage can also be set based on customers' requirements. In this way, the user can create waveform between 8V to 32V.

Note

When recalling the DIN40839 waveform, to ensure the validity of the DIN40839 waveform, the user needs to enable the internal load function at first and then set the current of internal load to the maximum value. Please refer to [3.14 Load Function](#) for the detailed operation.

- DIN40839 for 12V system:

Steps	Voltage (V)	Current(A)	Width(mS)	Slope(mS)
1	4.5	60	15	5
2	6	60	2000	5
3	12	60		10

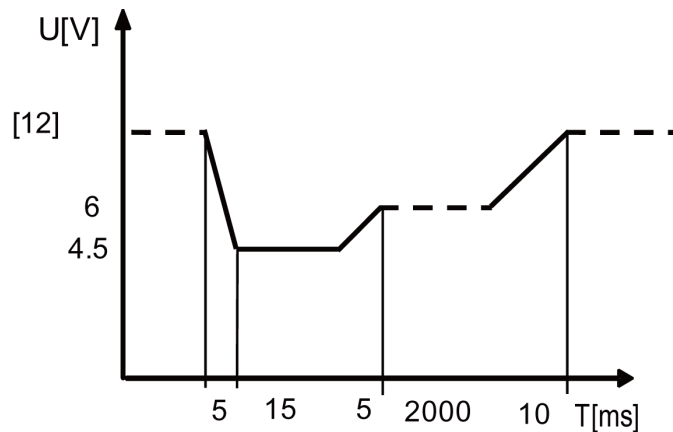

- DIN40839 for 24V system:

Steps	Voltage (V)	Current(A)	Width(mS)	Slope(mS)
1	8V	60	50	10
2	12	60	2000	5
3	24V	60		10

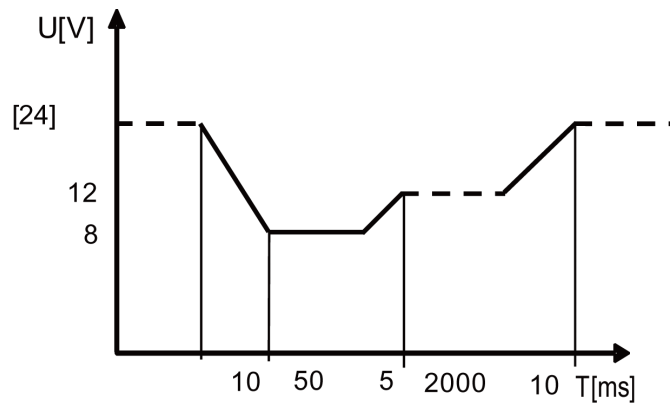

How to recall “DIN40839 waveform” from menu (take 12V system as an example):

1. Press **[Shift]+ [I-set]**(Function) to enter the Menu operation.
 2. Select **Road-Vehicle** with Left/Right key and press **[Enter]** for confirmation.
 3. Select **DIN40839** with Left/Right key and press **[Enter]** for confirmation.
 4. Select **On** with Left/Right key and press **[Enter]** for confirmation.
 5. Select **12V** with Left/Right key and press **[Enter]** for confirmation.
 6. DIN40839 appears at the right bottom of the panel.
 7. Press **[On/Off]** to turn on power supply output.
 8. Press **[Shift]+[Enter]** (Trigger) for trigger. The power supply will output based on set sequence. Trig mark is lit.
- Start up voltage waveform program through user-defined function

The user can define the startup voltage, ranging from 8V to 32V. When the waveform program is divided into 8V-16V, the waveform is consistent with standard 12V; when the waveform program is divided into 16V-32V, the waveform is consistent with the standard 24V waveform. The waveform diagram is shown below.

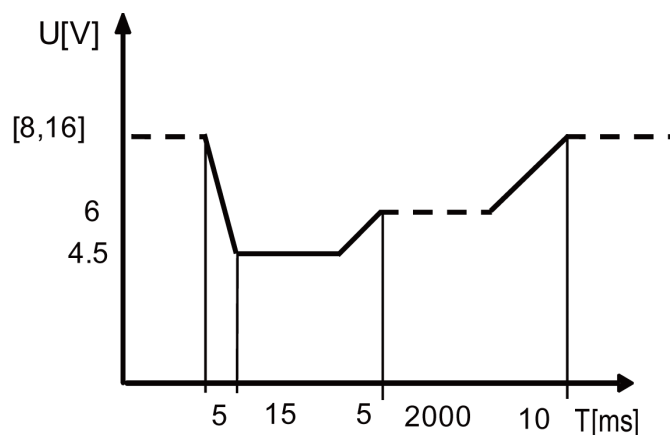

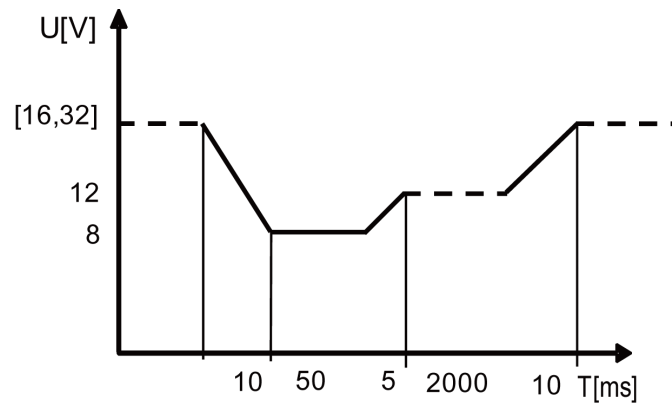

Call the self-defined DIN waveform operation (taking 12.5V voltage waveform as an example):

1. Press **[Shift]+ [I-set]**(Function) to enter the Menu operation.
2. Select **Road-Vehicle** with Left/Right key and press **[Enter]** for confirmation.
3. Select **DIN40839** with Left/Right key and press **[Enter]** for confirmation.
4. Select **On** with Left/Right key and press **[Enter]** for confirmation.
5. Press Left/Right key to select **User-defined**. Press **[Enter]** for confirmation.
6. Set the startup voltage value, V=12.6V. Press **[Enter]** for confirmation.
7. DIN40839 appears at the right bottom of the panel.
8. Press **[On/Off]** to turn on power supply output.
9. Press **[Shift]+[Enter]**(Trigger) for trigger. The power supply will output based on set sequence. Trig mark is lit.

3.21.2 simulate the waveform to verify the anti-interference performance of the automotive electronics' products

IT6500C models have built-in ISO16750-2 waveforms. To verify the anti-interference performance of the automotive electronics' products. Output pulse waveform completely meets the International Standard ISO-16750-2, convenient for quick recall by the user.



Note

When recalling the ISO16750-2 waveform, to ensure the validity of the waveform, the user needs to enable the internal load function at first and then set the current of internal load to the maximum value. Please refer to [3.14 Load Function](#) for the detailed operation.

Short voltage drop

This test simulates the effect when a conventional fuse element melts in another circuit.

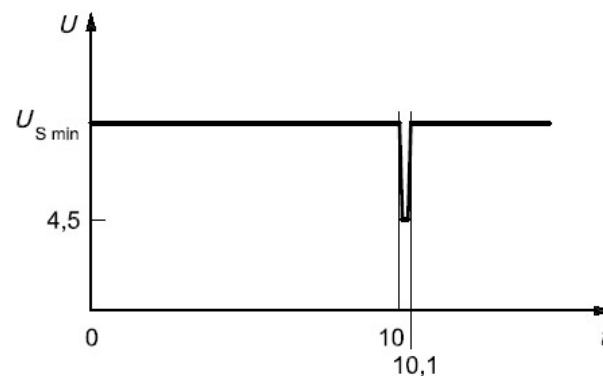
- 12V system



- 24V system

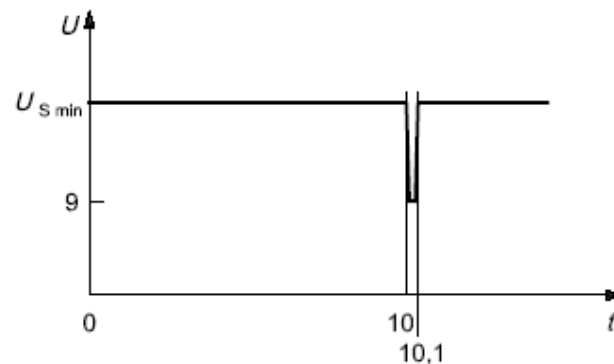

How to recall "Short voltage drop" waveform from menu (take 12V system as an example):

1. Press **[Shift]+ [I-set]**(Function) to enter the menu operation.
2. Press right direction key to select **ISO16750-2**, press **[Enter]**.
3. Press Left/Right direction keys to select **Short**, press **[Enter]**.
4. Press right direction key to select **On**, press **[Enter]**.
5. Press Up/Down direction key to select **12V**, press **[Enter]**.

VFD will display ISO-Short in the lower right corner.

6. Press **[On/Off]**, turn on the output.
7. Press **[Shift]+[Enter]**(Trigger) to generate a trigger signal. The DC source will output Short voltage drop waveform. The Trig indicating lamp will be lit and display on the VFD.



Note

Please make sure the trigger source is selected in MANUAL item in above operations (refer to step 7th).

Reset Test

This test verifies the reset behavior of the DUT at different voltage drops. This test is applicable to equipment with reset function, e.g. equipment containing microcontroller. Apply the test pulse simultaneously in figure below to all relevant inputs (connections) and check the reset behavior of the DUT. Decrease the supply voltage by 5 % from the minimum supply voltage, U_{Smin} , to $0,95U_{Smin}$. Hold this voltage for 5 s. Raise the voltage to U_{Smin} . Hold U_{Smin} for at least 10 s and perform a functional test. Then decrease the voltage to $0,9U_{Smin}$. Continue with steps of 5 % of U_{Smin} , as shown in Figure 6, until the lower value has reached 0 V. Then raise the voltage to U_{Smin} again.

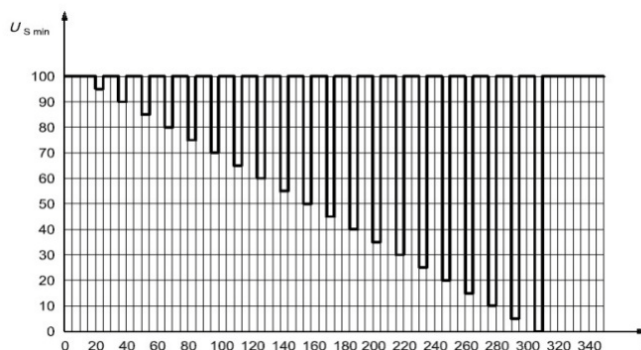

How to recall “Profile for the reset test” waveform from menu (take 12V system as an example):

1. Press **[Shift]+ [I-set]**(Function) to enter the menu operation.
2. Select **Road-Vehicles**, and press Right direction key to select **ISO16750-2**, press **[Enter]** to confirm.
3. Press Up/Down direction keys to select **Reset**, press **[Enter]** to confirm.
4. VFD display **Usmin...**, press **[Enter]** to confirm. VFD will display **Usmin=12.000V**, user can select the Usmin level.
5. Press Right direction key to **On**, press **[Enter]** to confirm.
6. Press **[On/Off]**, turn on the output.

- Press **[Shift]+[Enter]** (Trigger) to generate a trigger signal. The DC source will output Short voltage drop waveform. The Trig indicating lamp will be lit and display on the VFD.

Note

Please make sure the trigger source is selected in MANUAL item in above operations(refer to step 7th).

Starting Waveform

This test verifies the behavior of a DUT during and after cranking. Apply the starting profile ten times, as specified in Figure and Table below simultaneously to all relevant inputs (connections) of the DUT. A break of 1 s to 2 s between the starting cycles is recommended. One or more profiles as described in Tables 3 and 4 shall be chosen in accordance with the application.

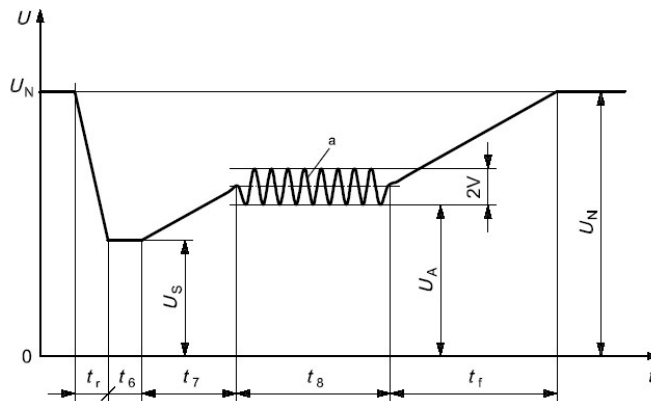

af=2HZ

- Standards for 12V system:

Curve should be selected based on actual test requirements. To create waveform within 12V, follow the set standards as below:

Levels/voltages/duration of starting profile				
I	II	III	IV	Tolerances
$U_S = 8 \text{ V}$	$U_S = 4,5 \text{ V}$	$U_S = 3 \text{ V}$	$U_S = 6 \text{ V}$	+ 0,2 V
$U_A = 9,5 \text{ V}$	$U_A = 6,5 \text{ V}$	$U_A = 5 \text{ V}$	$U_A = 6,5 \text{ V}$	
$t_r = 5 \text{ ms}$				± 10 %
$t_6 = 15 \text{ ms}$				
$t_7 = 50 \text{ ms}$				
$t_8 = 1 \text{ s}$	$t_8 = 10 \text{ s}$	$t_8 = 1 \text{ s}$	$t_8 = 10 \text{ s}$	
$t_f = 40 \text{ ms}$	$t_f = 100 \text{ ms}$	$t_f = 100 \text{ ms}$	$t_f = 100 \text{ ms}$	

- Standards for 24V system:

Levels/voltages/duration of starting profile			
I	II	III	Tolerances
$U_S = 10 \text{ V}$	$U_S = 8 \text{ V}$	$U_S = 6 \text{ V}$	+ 0,2 V
$U_A = 20 \text{ V}$	$U_A = 15 \text{ V}$	$U_A = 10 \text{ V}$	
$t_r = 10 \text{ ms}$			± 10 %
$t_6 = 50 \text{ ms}$			
$t_7 = 50 \text{ ms}$			
$t_8 = 1 \text{ s}$	$t_8 = 10 \text{ s}$	$t_8 = 1 \text{ s}$	
$t_f = 40 \text{ ms}$	$t_f = 100 \text{ ms}$	$t_f = 40 \text{ ms}$	

How to recall “Starting Profile” waveform from menu (take 12V system as an example):

1. Press **[Shift]+ [I-set]**(Function) to enter the menu operations.
2. Select **Road-Vehicles**, and press Right direction key to select **ISO16750-2**, press **[Enter]**.
3. Press Left/Right direction keys to select **Start**, press **[Enter]** to confirm.
4. Press Right direction key to **On**, press **[Enter]**.
5. Press Left/Right direction keys to select 12V/24V, and set the levels, press **[Enter]** to confirm.
6. Press **[On/Off]**, turn on the output.
7. Press **[Shift]+[Enter]** (Trigger) to generate a trigger signal. The DC source will output Short voltage drop waveform. The Trig indicating lamp will be lit and display on the VFD.



Note

Please make sure the trigger source is selected in MANUAL item in above operations(refer to step 7th).

Load dump dynamic behavior

This test is a simulation of load dump transient occurring in the event of a discharged battery being disconnected while the alternator is generating charging current with other loads remaining on the alternator circuit at this moment.

- The amplitude of load dump is determined by the rotational speed of alternator and the strength of magnetic field in the case of disconnection of the battery.
- The pulse duration of load dump is mainly determined by the time constant and pulse amplitude of the excitation circuit.

Inside most novel alternator, the amplitude of load dump is decreased by increasing the limiter diode (clamping diode). The load dump may be caused by cable corrosion, poor cable contact or disconnecting the battery intentionally when the engine is running.

The pulse shape and parameters for an alternator without centralized load dump suppression are given in follow.

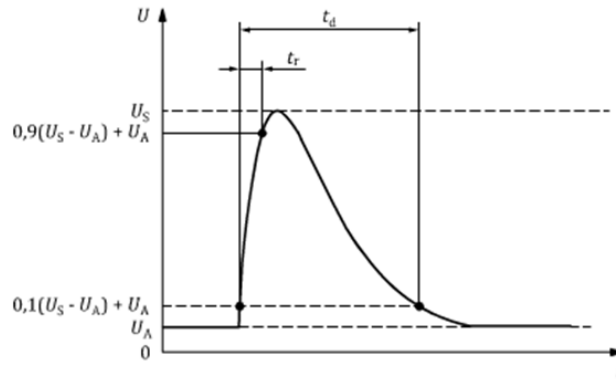

Description:

- t : time
- U : test voltage
- t_d : Duration of pulse
- t_r : Rising Slope
- U_A : Supply Voltage for generator in operation (see ISO 16750-1)
- U_S : supply Voltage

Parameter	Type of system		Minimum test requirements
	UN=12V	UN=24V	
$U_{Sa}(V)$	$79 \leq U_S \leq 101$	$151 \leq U_S \leq 202$	10 pulses at 1 min intervals
$R_{ia}(\Omega)$	$0.5 \leq R_i \leq 4$	$1 \leq R_i \leq 8$	
$t_d(ms)$	$40 \leq t_d \leq 400$	$100 \leq t_d \leq 350$	
$t_r(ms)$			
If not otherwise agreed, use the upper voltage level with the upper value for internal resistance or use the lower voltage level with the lower value for internal resistance.			

LOAD DUMP, SINGLE PULSE - WITH CENTRALIZED LOAD DUMP SUPPRESSION

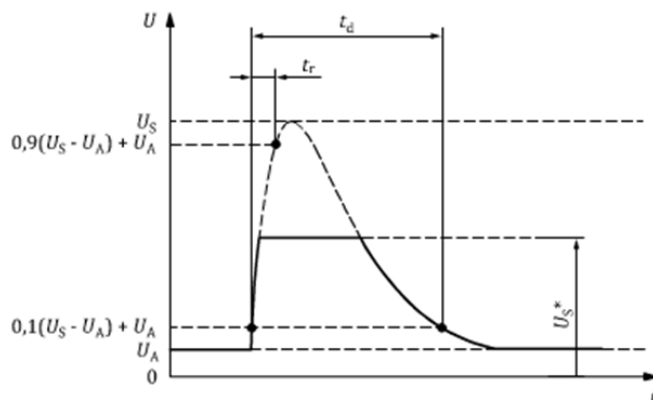

Description:

- t : time
- U : test voltage
- t_d : Duration of pulse
- t_r : Rising Slope
- U_A : Supply Voltage for generator in operation (see ISO 16750-1)
- U_S : Supply Voltage
- U_S^* : supply voltage with load dump suppression

Parameter	Type of system		Minimum test requirements
	UN=12V	UN=24V	
$U_{Sa}(V)$	$79 \leq U_S \leq 101$	$151 \leq U_S \leq 202$	5 pulses at 1 min intervals
$U_{S^*}(V)$	35	As specified by customer (typical value 58)	
$R_{ia}(\Omega)$	$0.5 \leq R_i \leq 4$	$1 \leq R_i \leq 8$	
$t_d(ms)$	$40 \leq t_d \leq 400$	$100 \leq t_d \leq 350$	
$t_r(ms)$			
If not otherwise agreed, use the upper voltage level with the upper value for internal resistance or use the lower voltage level with the lower value for internal resistance.			

The following general considerations of the dynamic behavior of alternators during load dump apply:

- The internal resistance of an alternator, in the case of load dump, is mainly a function of alternator rotational speed and excitation current.

- The internal resistance, R_i , of the load dump test pulse generator shall be obtained from the following relationship.

$$R_i = \frac{10 \times U_{\text{nom}} \times N_{\text{act}}}{0.8 \times I_{\text{rated}} \times 12000 \text{min}^{-1}}$$

where:

- U_{nom} : is the specified voltage of the alternator
 - I_{rated} : is the specified current at an alternator speed of 6000 min^{-1} (as given in ISO 8854)
 - N_{act} : is the actual alternator speed, in reciprocal minutes
- The pulse is determined by the peak voltage U_n , U_a , the internal resistance R_i , and the pulse duration t_d ; in all cases small values of U_n are correlated with small values of R_i and t_d , and high values of U_n with high values of R_i and t_d . For the test voltage U_A please refer to ISO16750-1.

3.21.3 42V Road vehicles — Electrical and electronic equipment for a supply voltage of 42 V — Electrical loads

A test wave completely conforming to International Standard ISO21848 is built inside the device, which can be used for the test of Electrical and electronic equipment for a supply voltage of 42V - Electrical loads. The user can directly and quickly recall this function during test.



Note

When recalling the ISO21848 waveform, to ensure the validity of the waveform, the user needs to enable the internal load function at first and then set the current of internal load to the maximum value. Please refer to [3.14 Load Function](#) for the detailed operation.

$U_{\text{max,dyn}}$ test pulse

Detect the function when the DUT is under maximum dynamic Voltage $U_{\text{max,dyn}}$, and simulate the maximum dynamic Voltage of high-energy pulse raised from throw load in 42V electrical system, where the upper limit is the protection voltage of throw load.

Apply 1 test pulse to the DUT, as shown below:

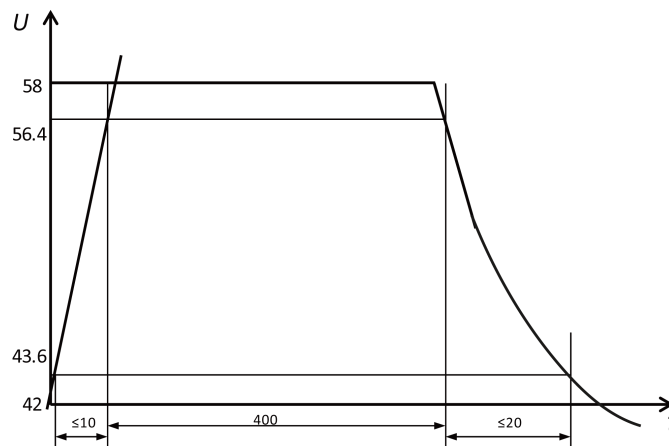

- t: time (in ms)
- U: Voltage (in V)

Supply Voltage Transient Drop

Simulate the affect from short circuit when fuse element of another circuit is melt. Detect the function status of the DUT at transient drop of Voltage.

When the given test pulse is applied at all input terminals of the DUT, the rise and fall time between U_{low} and 16V level shall not be longer than 10ms.

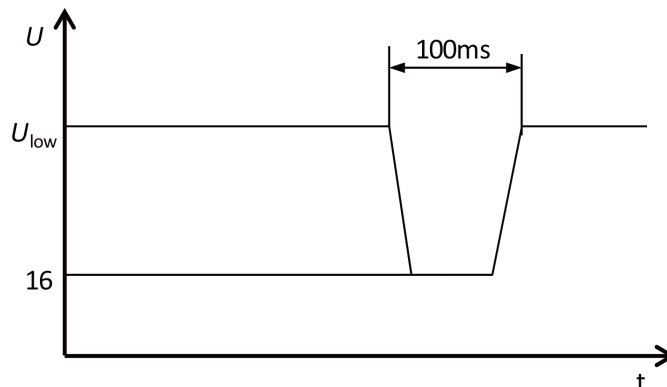

- t: time (in s)
- U: voltage (in V)

Reset Performance at Transient Drop of Voltage

Detect the reset performance of the DUT at different Voltage drops. Applicable for devices with reset function (for example, device installed with one or several micro controllers) .

As shown in the figure, apply test pulse and detect the reset performance of the DUT.

The supply voltage drops from U_{low} to $0.95U_{low}$ by 5% and keeps for 5s, and then rise to U_{low} and keep for at least 10s for function test. Then, drop Voltage to

$0.9U_{low}$, and so on. As shown in the figure, drop the voltage from U_{low} to 0V by 5% and raise the voltage to U_{low} . The Rise and Fall time shall be between 10ms and 1s.

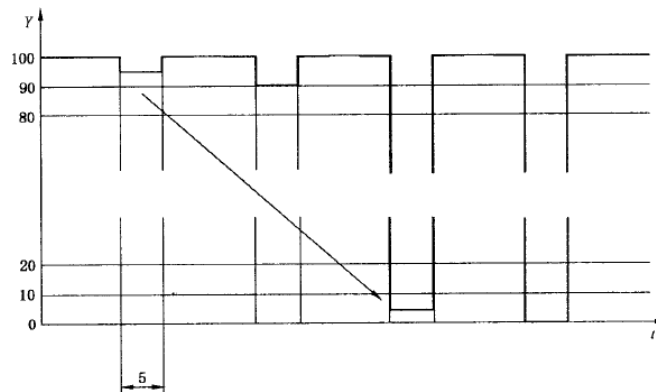

- t: time (in s)
- Y: U_{low} , %

Start-up Characteristics

Detect DUT characteristics before and after vehicle startup.

Apply the startup characteristic parameters as shown in the figure and table to related input terminals of the DUT simultaneously.

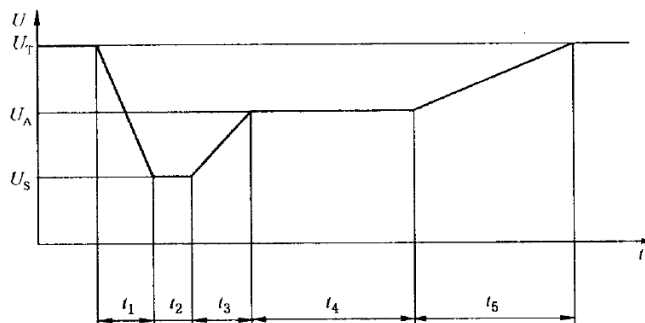

- t: time (in s) t1: 5ms
- U: voltage (in V) t2: 15ms
- U_S : 18V t3: 50ms
- U_A : 21V t4: 10000ms
- U_T : 42V t5: 100ms

3.21.4 SAEJ1113-11 Waveform protocol



Note

When recalling this waveform, to ensure the validity of the waveform, the user needs to enable the internal load function at first and then set the current of internal load to the maximum value. Please refer to [3.14 Load Function](#) for the detailed operation.

Test 2b

Transient from DC motors acting as generators after ignition switch OFF

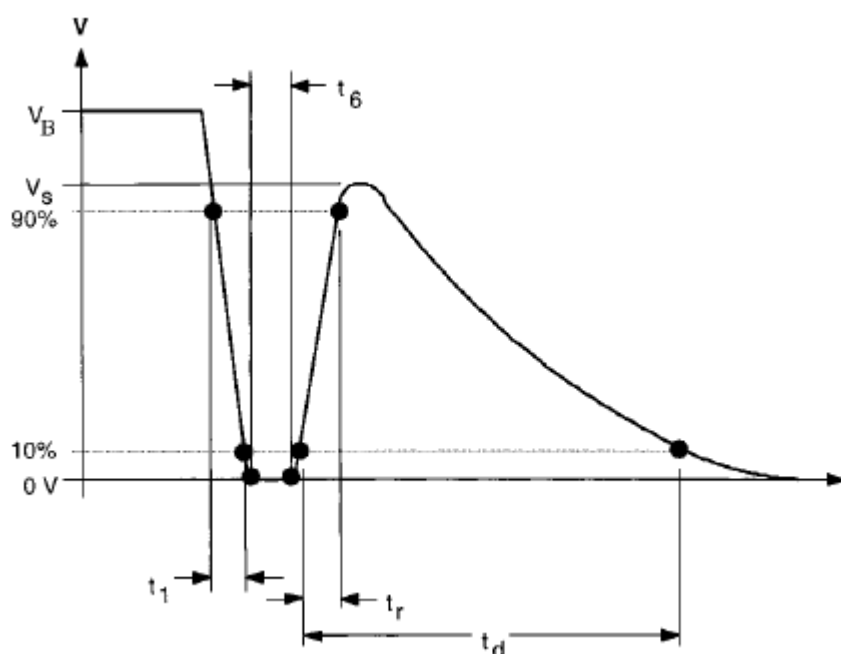

Parameters	12V System	24V System
V_s	10V	20V
R_i	$\leq 0.05\Omega$	$\leq 0.05\Omega$
t_d	0.2 to 2s	0.2 to 2s
t_1	1ms \pm 50%	1ms \pm 50%
t_r	1ms \pm 50%	1ms \pm 50%
t_6	1ms \pm 50%	1ms \pm 50%

Test 4

Starter motor engagement disturbance pulse.

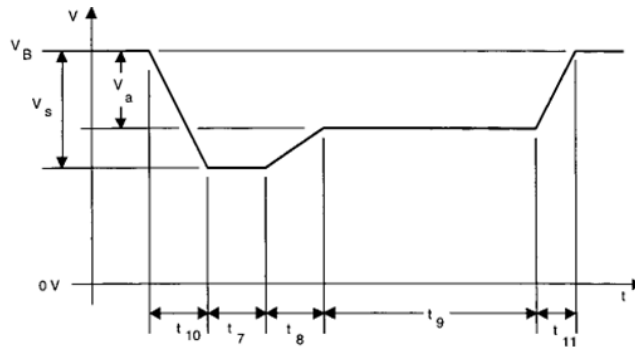

Parameters	12V System	24V System
V_s (From V_B)	-4V to -7V	-5V to -16V
V_a (From V_B)	-2.5 to -6V with $ V_a \leq V_s $	-5 to -12V with $ V_a \leq V_s $
R_i	0 Ω to 0.02 Ω	0 Ω to 0.02 Ω
t_7	15 to 40ms ⁽¹⁾	50 to 100ms ⁽¹⁾
t_8	≤ 50 ms	≤ 50 ms
t_9	0.5 to 20s ⁽¹⁾	0.5 to 20s ⁽¹⁾
t_{10}	5ms	10ms
t_{11}	5 to 100ms ⁽²⁾	10 to 100 ms ⁽³⁾

1. The value used should be agreed between the vehicle manufacturer and the equipment supplier to suit the proposed application.
2. $t_{11}=5$ ms is typical of the case when engine starts at the end of the cranking period, while $t_{11}=100$ ms is typical of the case when the engine does not start.
3. $t_{11}=10$ ms is typical of the case when engine starts at the end of the cranking period, while $t_{11}=100$ ms is typical of the case when the engine does not start.

Test 5

For the details, please refer to the [3.21.2 simulate the waveform to verify the anti-interference performance of the automotive electronics' products](#).

3.21.5 LV124

IT6500C series all come with built-in curves which meet general requirements, test conditions and tests of electrical and electronic components in motor vehicles up to 3.5 t.

Note

When recalling this waveform, to ensure the validity of the waveform, the user needs to enable the internal load function at first and then set the current of internal load to the maximum value. Please refer to [3.14 Load Function](#) for the detailed operation. And the CC/CV priority of power need to be CV option.

E-02 Transient Overvoltage Pulse

Transient overvoltages may occur in the electric system due to the switching off of loads and due to short accelerator tip-ins. These overvoltages are simulated by means of this test. This test may be used for the electrical life test. The test pulse of E-02 Transient overvoltage is shown in the next figure.

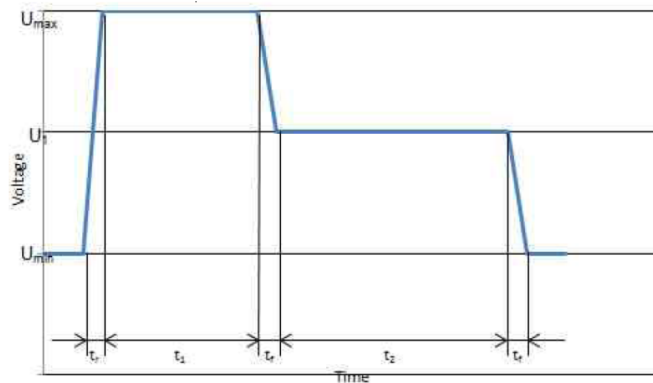

E-04 Jump Start

External starting of the vehicle is simulated. The maximum test voltage results from commercial vehicle systems and their increased power supply voltage.

The test pulse of E-04 Jump start is shown in the next figure.

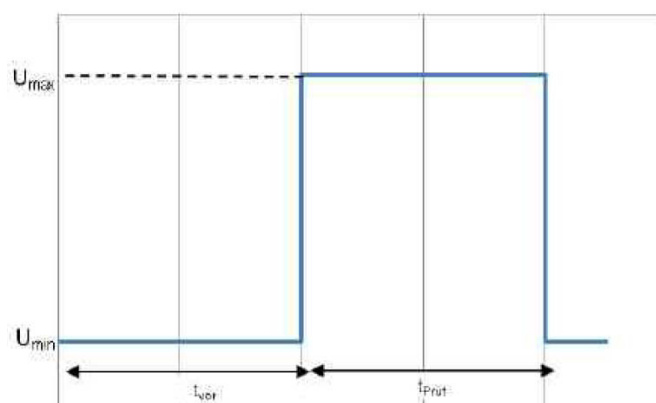

E-05 Load Dump

Dumping of an electric load, in combination with a battery with reduced buffering ability, results in an energy-rich overvoltage pulse due to the generator characteristics. This pulse is simulated by means of this test.

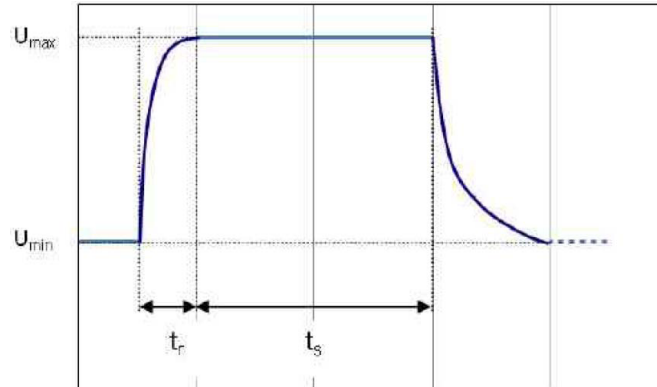

E-07

The slow decrease and increase of the supply voltage is simulated as it occurs during the slow discharging and charging procedure of the vehicle battery.

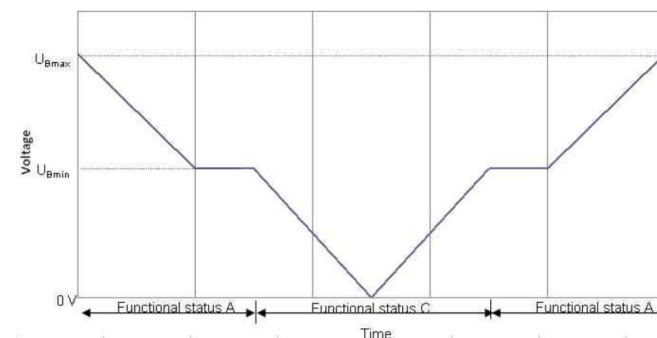

E-08 Slow Decrease, Quick Increase of the Supply Voltage

This test simulates the slow decrease of the battery voltage to 0 V and the sudden reconnection of the battery voltage e.g. by means of applying a jump start source.

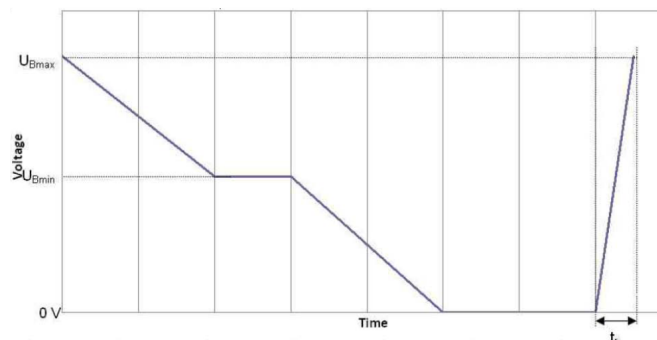

E-09 Reset Behavior

The reset behavior of a component in its environment is simulated and tested. Test boundary conditions (e.g. assembly, terminal, system) must be described in detail. During operation, an arbitrary sequence of repeated switching-on/off procedures occurs; this must not lead to an undefined behavior of the component. The reset behavior is represented by a voltage variance and a time variance. Two different test sequences are required to simulate different switch-off times. A component must always undergo both sequences.

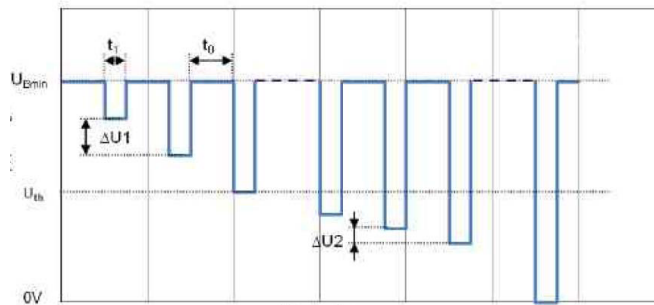

E-11 Start Pulses

When starting the engine, the battery voltage drops to a low value for a short period and then slightly rises again. Most components are activated directly before starting for a short period, then deactivated during starting and activated again after starting when the engine is running. This test serves to verify normal operation under these conditions. The starting process may be performed under different vehicle starting conditions, cold start and warm start. In order to cover both cases, two different test sequences are required. A component must always undergo both sequences.

- Cold Start Test Pulse

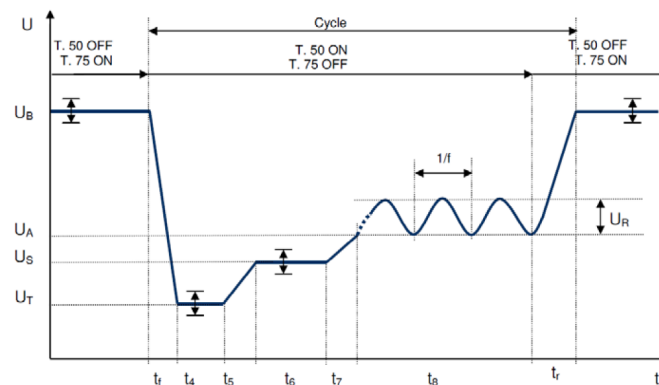

- Warm Start Test Pulse

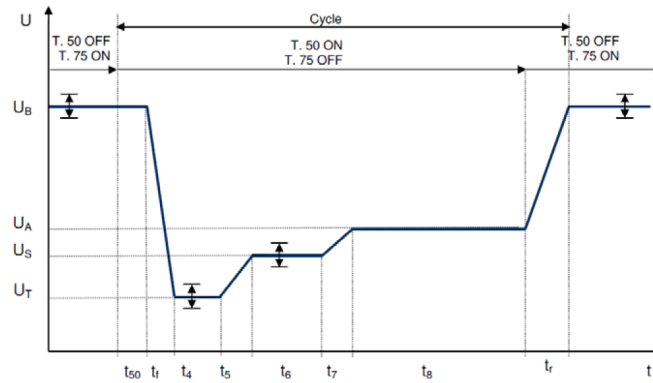

E-12 Voltage Curve with Intelligent Generator Control

The behavior of the electric system when intelligent generator controls are used is simulated. The behavior goes from DC to voltage changes within max. 300 ms.

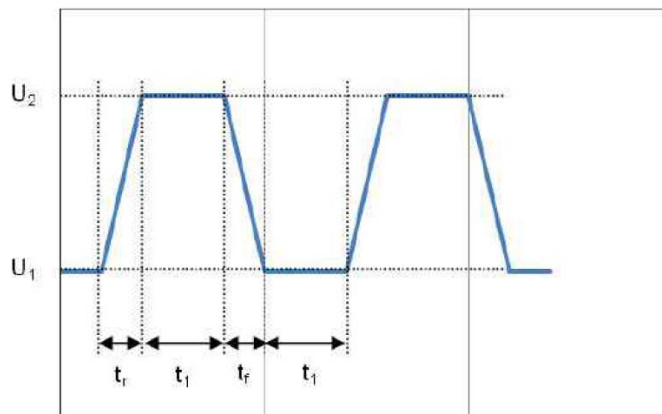

3.22 DC Internal Resistance Measure

In addition to various test functions of original power supply, this Series of power supply provides measure function for internal resistance at charging and discharging the battery, which needs no various detection devices.

To measure the DUT internal resistance, turn on the DC internal resistance measure function in the menu and set the DUT capacity. During measure, the Meter interface will display the real-time DC internal resistance of the DUT.

DCR	DC internal resistance measure	
	Battery Capacity = 0AH	Input battery capacity
	Off/On	Turn off/on DC internal resistance measure function

To turn on the DC internal resistance measure, follow the steps below:

1. Press **[Shift]+[I-set]**(Function) to enter the menu for operation.
2. Press the right key to select **DCR** in the menu and press **[Enter]** for confirmation.
3. Set battery capacity, where Battery Capacity =1AH.
Battery Capaticy =1AH
4. Select On to turn on DC internal resistance measure function.
5. The Meter interface displays as follows. The precision of different models are different, and the interface displays are not exactly the same. Please refer to the actual display.

```

OFF
0.000V      0.000A
0.000Ω
    
```

3.23 Parallel Operation

CAUTION

- When connecting the system bus, please note the built-in terminal matching resistance at the rear panel. If the resistance is removed, the instrument may not work properly. The user can install the terminal matching resistance on the Input end of the first system bus and the Output end of the last system bus. Please place the removed terminal matching resistance in a safe location. If you need to change to the single device operation mode, you need to re-attach the terminal matching resistance.
- The system bus interface is not isolated from the output electrode. After power on, it is not allowed to insert or pull out the bus and terminal matching resistance.
- During wiring, check that the anode and cathode of the parallel output cables are properly and tightly connected; anode ON and cathode OFF are prohibited.

This series of power supply supports mutual parallel operation of same models and to increase output power and output current. In addition, active current sharing is provided for parallel instruments.

The figure below shows 3 pcs power supplies in parallel, in which, the system bus is used for master-slave connection.

Figure 3–1 Schematic Diagram of 3 Pcs Power Supplies in Parallel

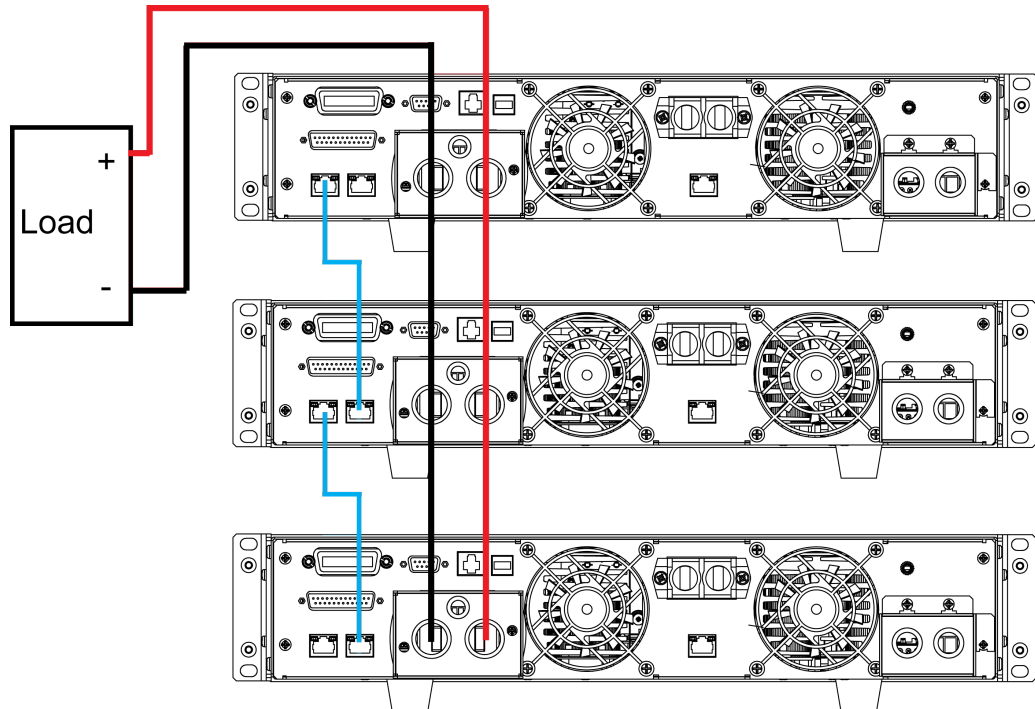

The master-slave connection for configuring 3 pcs power supplies is as follows:

1. Configure one power supply as the Master and the other power supplies as Slave. Press the composite key **[Shift]+[P-set]**(Menu) to enter the System Menu.
2. Press the Right key to select **CONFIG** and press **[Enter]** to enter the Configuring Menu.
3. Press the Right key to select **Parallel** and press **[Enter]** for parallel setting.
 - Single: Single mode.
 - Slave: Salve mode.
 - Master: Master mode. If Master mode is selected, you need to set the number of Salves for the Master.

Mount: total number of instruments in parallel. For example, Mount=3.

4. After setting of host and slave, switch off the power supply. Connect the networking.
5. Connect the networking as shown above. Please connect the network after parallel setup. Otherwise, at start up, the power supply will detect parallel setup fault and fail to start up.

To change Parallel Mode to Single Mode, follow the steps below:

1. Power off the power supplies.
2. Remove System Bus among the power supplies.
3. Install the terminal matching resistance on the device which is uninstalled. Insert it to the Input or Output of the System Bus interface.
4. Restart the power supply and enter to “NETWORKING...” status.
5. Press **[shift]+[Esc]**, clear the error status and set the master mode or slave mode to single mode.
6. Repeat steps 3 through 4 for each device under parallel mode to change all devices to single operation mode.

3.24 Analogue Interface (Enhanced Isolation)

A DB25 analog interface is set at the rear panel of the power supply, through which, you can connect the external voltage (0V-5V/0V-10V) or external resistance (0K Ω -5K Ω /0K Ω -10K Ω) to program output voltage or current on 0-full range. At the same time, with analog monitoring function (0V-5V/0V-10V), you can monitor the output voltage or current on 0-full range.

Analog signal bandwidth is less than 100Hz, support any waveform within signal bandwidth. When the program signal frequency or amplitude exceeds output capacity, the output amplitude will be automatically limited.

In parallel operation, you can program or monitor output through the host analog interface. The 0V-5V/0V-10V program and monitoring range is changed to 0-full range of parallel machine. Safe electrical isolation is set between this analog interface and output electrode.

To run this function, you need to set the parameters below:

Monitor	10V(Def)	10V monitoring mode options
	5V	5V monitoring mode options
Ext- Ctrl	External control mode and related parameter setting	
	Voltage (Def)	Voltage setting mode selection
	10V(Def)/5V	10V or 5V setting mode selection, select by Left/Right key.
	Resistance	Resistance setting mode selection

	10k(Def)/5k	10K or 5K setting mode selection, select by Left/Right key.
	Off	Disable or enable this function. Select by up/down key.
	On	

The above parameters can be selected through the configuration menu.

1. Press the **[Shift]+[P-set]**(Menu) to enter the menu.
2. Press the Right Key to select **CONFIG** and press **[Enter]** to enter the configuration menu.
3. Press the Right Key to select the **Ext-Ctrl** and press **[Enter]** to enter the configuration of external analog parameters. When setting every item, please use the Up/Down Key for selection.

After selecting the **Ext-Ctrl** as **On**, exit the Menu. At this time, the Rear indicator on the VFD status bar will be lighted on and the right corner will display **Analog**.

Figure 3–2 DB25 Analogue Interface Description

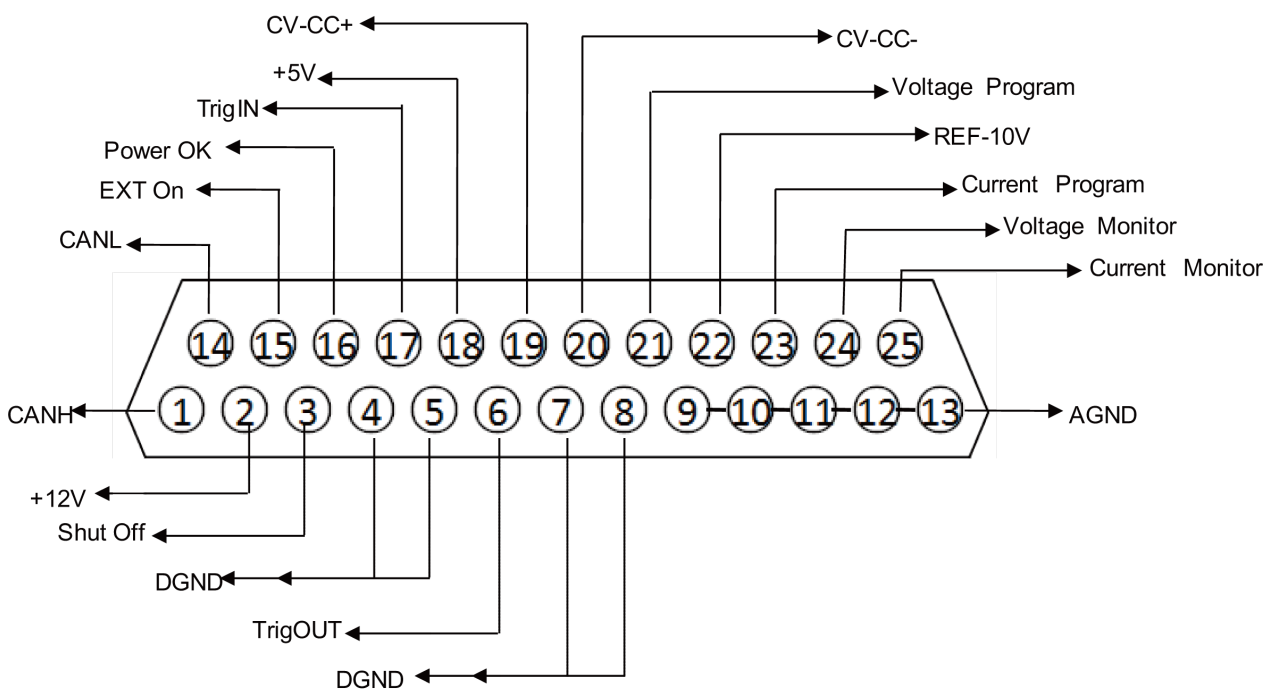

Pin	Name	Description
Pin 1 and Pin 14	CANH CANL	Pin 1 used for CAN H interface, and Pin 14 used for CAN L interface.
Pin 2	+12V	Power supply output 12V, driving capacity 0.1A
Pin 3	Shut Off	Used for switching off the function under emergency status (In general circumstances, the pin is suspended, and defaulted to low level); when external high level is connected, output is off.
Pin 15	EXT ON	Used for controlling output On/Off of the power supply; default setting is high level. Output is controlled by On/Off; when external low level is connected, or when it is short circuited to DGND, output is switched off. At this time, setting of output On/Off fails.
Pin 16	Power OK	Used for indicating whether the power output is normal; if so, output 5V; in case of power supply failure, output 0V.
Pin 17	TrigIN	Input signal of reverse protection mode. When input is low level, alarm "OutPut Reverse Protect" fault. At the mean while, in external trigger mode, when input is low level, then actualize trigger function.
Pin 6	TrigOUT	Output signal of reverse protection mode. When power supply output is On, this pin outputs high level; when this power supply output is Off, this pin outputs low level; it can be used for synchronous control of On/Off for other devices with driving capacity of 5V/5mA.
Pin 18	+5V	The power supply outputs 5V voltage, which is used for digital power supply with driving capacity of 0.1A.
Pin 19 and Pin 20	CV_CC+ CV_CC-	The output between these two pins is used for indicating the working status of power supply; under CV mode, the output between these two pins is 5V; and under CC mode, - 5V.
Pin 21	Voltage Program (Voltage setting)	Output voltage of analog control: In setting the Voltage and 10v, the input analog range should be 0-10V voltage, and the regulated output voltage should be from 0 to full range; In setting the Voltage and 5v, the input analog range should be 0-5V voltage, and the regulated output voltage should be from 0 to full range;

Pin	Name	Description
		<p>In setting the Resistance and 10K, the input analog range should be 0-10K resistance, and the regulated output voltage should be from 0 to full range;</p> <p>In setting the Resistance and 5K, the input analog range should be 0-5K resistance, and the regulated output voltage should be from 0 to full range;</p>
Pin 22	REF_10V	The 10V reference voltage output by the power supply can be connected to a resistance subdivision for analog control.
Pin 23	Current Program (Current Setting)	<p>Output current of analog control:</p> <p>In setting the Voltage and 10v, the input analog range should be 0-10V voltage, and the regulated output current should be from 0 to full range;</p> <p>In setting the Voltage and 5v, the input analog range should be 0-5V voltage, and the regulated output current should be from 0 to full range;</p> <p>In setting the Resistance and 10K, the input analog range should be 0-10K resistance, and the regulated output current should be from 0 to full range;</p> <p>In setting the Resistance and 5K, the input analog range should be 0-5K resistance, and the regulated output current should be from 0 to full range;</p>
Pin 24	Voltage Monitor (Voltage monitoring)	<p>The actual value from monitoring is the corresponding monitor voltage value. For example, when the analog voltage is 10V, power supply control voltage 0~80V and the power supply output voltage 20V, this pin will output 2.5V voltage.</p> <p>Similarly, when the analog voltage is 5V, control voltage 0~80V and the power supply output voltage 20V, this pin will output 1.25V voltage.</p>
Pin 25	Current Monitor (Current monitoring)	<p>The actual value from monitoring is the corresponding monitor voltage value. For example, when the analog voltage is 10V, power supply control current 0~120A and the power supply output current 12A, this pin will output 1V voltage.</p> <p>Similarly, when the analog voltage is 5V, control current 0~120A and the power supply output current 12A, this pin will output 0.5V voltage.</p>

Pin	Name	Description
Pins 9, 10, 11, 12 and 13	Connection to AGND	Ground wires for analog interfaces (including Pin 21 VPRG, Pin 22 REF_10V, Pin 23 IPRG, Pin 24 VMON, Pin 25 IMON).
Pins 4, 5, 7,8	Internal connection to DGND	Ground wires for Pin 15 EXT ON, Pin 3 SHUT OFF, Pin 16 POWER OK, Pin 17 TrigIN, Pin 6 TrigOUT, Pin 19 CV_CC+ and Pin 20 CV_CC-.

Note

- The value of the output current must be under the definition value of the current which is driving capacity in the DB25 pins of the power supply. Otherwise, the power supply will be damaged.
- The maximum digital signal input voltage $\leq 5V$
- The maximum analog signal input voltage $\leq 12V$

Voltage Setting (Voltage Program)

This function enables change of voltage output through external analog signal by connecting external DC voltage (under voltage mode) or an external resistor (under resistor mode) to Pin 21. To enable this function, the output control should be under the external analog control mode. Used for controlling the external voltage range of full-scale output voltage or the resistor can be selected from 0~5V/0~10V or 0~5K Ω /0~10K Ω . To switch on the voltage setting, the operations as follows:

1. Select the **MENU (Menu)**→**CONFIG (Configure)**→**Ext-Ctrl (External Analog Control)**.
2. Press the Right Key to select Voltage (or Resistance).
3. Press the Right/Left Key to select the voltage mode or resistor mode.

- Voltage Mode

Under voltage mode, the user can set the voltage output value of power supply through Pin 21.

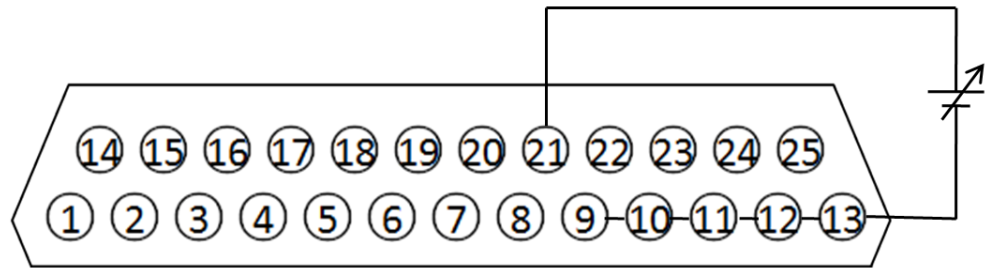

- Resistor Mode

Pin 21 and Pin 13 (GND wire) can be connected to a resistor for setting the output voltage value of the power supply.

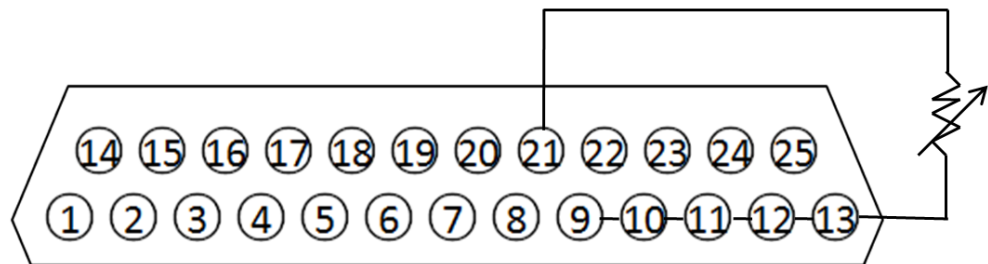

To set the 0~5V/0~10V or 0~5KΩ/0~10KΩ external analog setting range, the operations as follows:

1. Select the **MENU (Menu)→CONFIG (Configure)→Ext-Ctrl (External Analog Control)**.
2. Press the Right Key to select Voltage (or Resistance).
3. Press the Right Key to select 5V/10V or 5KΩ/10KΩ.

Current Setting (Current Program)

This function enables change of current output through external analog signal by connecting external DC voltage (under voltage mode) or an external resistor (under resistor mode) to Pin 23. To enable this function, the output control, should be under the external analog control mode. Used for controlling the external voltage range of full-scale output voltage or the resistor can be selected from 0~5V/0~10V or 0~5KΩ/0~10KΩ. To switch on the current setting, the operations as follows:

1. Select the **MENU (Menu)→CONFIG (Configure)→Ext-Ctrl (External Analog Control)**.
2. Press the Right Key to select Voltage (or Resistance).
3. Press the Right/Left Key to select the voltage mode or resistor mode.

- Voltage Mode

Under the voltage mode, the user can set the voltage output value of the power supply through Pin 23.

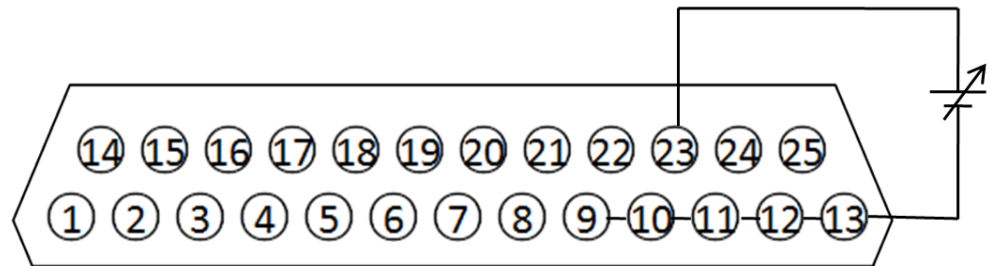

- Resistor Mode

Pin 23 and Pin 13 (GND wire) can be connected to a resistor for setting the output voltage value of the power supply.

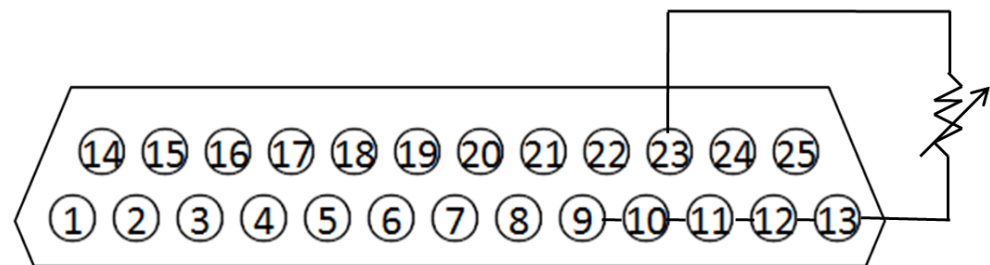

To set the 0~5V/0~10V or 0~5K Ω /0~10K Ω external analog setting range, the operations as follows:

1. Select the **MENU (Menu)**→**CONFIG (Configure)**→**Ext-Ctrl (External Analog Control)**.
2. Press the Right Key to select Voltage (or Resistance).
3. Press the Right Key to select 5V/10V or 5K Ω /10K Ω .
- 4.

Voltage monitoring

This function enables monitoring of voltage output via Pin 24 or the GND pin (i. e., Pin 13), which can be connected to a digital voltmeter (DVM). To use this function, the output control should be under the external analog control mode. The output voltage monitoring range (which reflects the power supply output voltage from zero to full scale) can be selected from 0-10V or 0-5V. To switch on the monitoring range setting, the operations as follows:

1. Select the **MENU (Menu)**→**CONFIG (Configure)**→**Monitor (External monitor mode)**.
2. Press the Right Key to select the output voltage monitoring range (0~10V or 0~5V).

The connection setting of digital voltmeter is shown below.

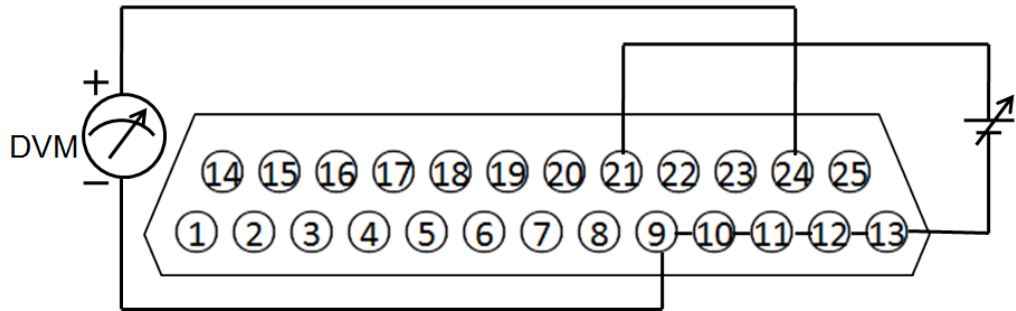

Current monitoring

This function enables monitoring of current output via Pin 25 or the GND pin (i.e., Pin 13), which can be connected to a digital voltmeter (DVM). To use this function, the output control should be under the external analog control mode. The output current monitoring range (which reflects the power supply output current from zero to full scale) can be selected from 0-10V or 0-5V. To switch on the monitoring range setting, the operations as follows:

1. Select the **MENU (Menu)→CONFIG (Configure)→Monitor (External monitor mode)**.
2. Press the Right Key to select the output current monitoring range (0~10V or 0~5V).

The connection setting of digital voltmeter is shown below.

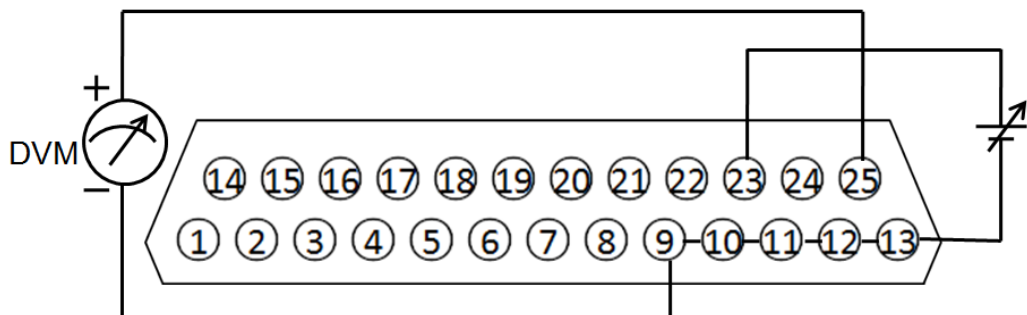

4 Remote Control

This series power supply have five standard communication interfaces: RS232, USB, GPIB, LAN and CAN. The customer can choose any one according to his demands.

- ◆ RS232 Interface
- ◆ USB Interface
- ◆ GPIB Interface
- ◆ LAN Interface
- ◆ CAN Communication Port

4.1 RS232 Interface

This series power supply have a DB9 interface on rear panel. Using a cable with two COM ports to connect power supply and PC. Then please enter the menu to configure the communication parameters. all SCPI commands can be used for programming.



Note

The setup about RS232 in the program should agree with the configuration in the system set. please enter the system Menu to change the communication parameters.

RS-232 Data style

RS232 with start bit and stop bit. The start bit and stop bit cannot be edited. While you could select the odd parity or even parity under the system set. Odd or EVEN options have been saved in the nonvolatile memory.

Baudrate

Edit baudrate: You can enter the menu setup, select the baudrate among the following options: 4800/ 9600/ 19200/ 38400/ 57600/ 115200

RS-232 connection

Please use a straight-through RS232 cable with DB9 interface and connect the RS232 serial port with the controller's serial port(for example. PC). The table as below gives a detailed description for each pin.

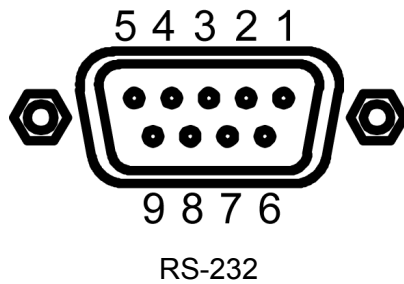

Pins	Description
1/4/6/9	connectionless
2	TXD, transmit data
3	RXD, receive data
5	GND
7	CTS, clear the sending
8	RTS, ready to send



Note

If your computer is using a RS-232 interface with DB-25 connector, you need an adapter cable with a DB-25 connector at one end and the other side is a DB-9(not blank modem cable).

RS-232 Troubleshooting:

If you meet some problems when communicating with PC by RS232 interface, please check the following items:

- PC and power supply must have the same configuration in the following items: baudrate, parity bit, data bit and flow control. Please note that power supply has been configured with a start bit and stop bit(the two values are fixed).
- Ensure you have used the correct communication cable. Please pay attention that some cable may not have a correct internal wiring even it is with a appropriate DB9 interface.
- The RS232 communication cable should have been connected to a correct serial port of the PC.

Communication Setup

Please ensure the PC and power supply have the same configuration in the following items.

Baud rate: 9600(4800, 9600, 19200, 38400, 57600, 115200).You could enter the system menu to set the baudrate.

Data bit: 8

Stop bit: 1

Parity bit: (none, even, odd)

- EVEN 8 data bits have even parity
- ODD 8 data bits have odd parity

- NONE 8 data bits have no parity

Native machine address: (0 ~31, factory default is 0)

Start Bit	8 Data Bits	Parity=None	Stop Bit
-----------	-------------	-------------	----------

4.2 USB Interface

Use a cable with two USB ports to connect power supply and PC. You can program through USB interface to achieve all functions of power supply.

The functions of USB488 interface are as follows:

- Interface is 488.2 USB488 interface
- Receive the following request: REN_CONTROL, GO_TO_LOCAL, and LOCAL_LOCKOUT
- When the interface receives MsgID = TRIGGER USBTMC command, it will transmit the TRIGGER command to the function layer

The functions of power supply's USB488 are as follows:

- receive all SCPI commands
- device is SR1 enabled
- device is RL1 enabled
- device is DT1 enabled

4.3 GPIB Interface

Use a IEEE488 bus to connect GPIB interfaces of power supply and PC. Please ensure that the screws have been screwed down in order to have a full connection. Then press **[Shift] + [P-set]** (Menu) to enter the system menu to set the address. The address range of power supply is 1-30. After you set the address, please press **[Enter]** button to confirm. GPIB address is saved in nonvolatile memory.

4.4 LAN Interface

When connect PC through LAN interface, the following is required to use the LAN interface. The LAN interface complies with the LXI standard.



Note

- When using one crossover cable to connect PC directly, the gateway address should be consistent with that of the PC, and the IP address should be at the same network segment with the PC's IP address.
- When the instrument and computer are connected to the router, an independent IP address must be assigned for the instrument.

The user can view the related information of LAN interface or configure the communication parameters in system menu.

View LAN Interface Information

The operation steps to view the LAN interface information are as follows.

1. Press **[Shift]+[P-set]**(Menu) to enter into the system menu interface.
2. Use left and right keys or rotate the voltage knob to select **SYSTEM** and press **[Enter]** key to confirm.
3. Use left and right keys or rotate the voltage knob to select **Communication** and press **[Enter]**key to confirm.
4. Use left and right keys or rotate the voltage knob to select **LAN** and press **[Enter]**key to confirm.

The first displayed menu item **Info** is to view the LAN interface information.

5. Press **[Enter]**key to confirm.
6. Use left and right keys or rotate the voltage knob to review the LAN interface information, Refer to [3.9 System Menu](#) for more information.
7. After setting, press **[Esc]** to exit.

Configure LAN Interface Information

The configurable parameters are described as follows.

The instrument address

- **IP Addr:** This value is the Internet Protocol (IP) address of the instrument. An IP address is required for all IP and TCP/IP communications with the instrument. An IP Address consists of 4 decimal numbers separated by periods. Each decimal number ranges from 0 through 255 with no leading zeros (for example, 169.254.2.20).
- **Sub Net:** This value is used to enable the instrument to determine if a client IP address is on the same local subnet. The same numbering notation applies as for the IP Address. When a client IP address is on a different subnet, all packets must be sent to the Default Gateway.

- Gateway: This value is the IP Address of the default gateway that allows the instrument to communicate with systems that are not on the local subnet, as determined by the subnet mask setting. The same numbering notation applies as for the IP Address. A value of 0.0.0.0 indicates that no default gateway is defined.
- DNS1: This field enters the primary address of the server. Contact your LAN administrator for server details. The same numbering notation applies as for the IP Address. A value of 0.0.0.0 indicates that no default server is defined.

DNS is an internet service that translates domain names into IP addresses. It is also needed for the instrument to find and display its hostname assigned by the network. Normally, DHCP discovers the DNS address information; you only need to change this if DHCP is unused or not functional.
- DNS2: This field enters the secondary address of the server. Contact your LAN administrator for server details. The same numbering notation applies as for the IP Address. A value of 0.0.0.0 indicates that no default server is defined.

LAN service

The configurable services include: mDNS, Ping, Telnet, Web, VXI-11 and Raw Socket.

The operation steps to configure are as follows.

- This configures the instrument address (IP Mode).
 1. Press **[Shift]+[P-set]**(Menu) to enter into the system menu interface.
 2. se left and right keys or rotate the voltage knob to select **SYSTEM** and press **[Enter]**key enter to system menu.
 3. se left and right keys or rotate the voltage knob to select **Communication** and press **[Enter]**key to confirm.
 4. se left and right keys or rotate the voltage knob to select **LAN** and press **[Enter]**key to confirm.
Select **Config** to configure.
 5. Press **[Enter]**key to confirm, This parameter is in modification.
 - Auto: automatically configure the addressing of the instrument
 - Manual: manually configure the addressing of the instrument
 6. After setting, press **[Esc]** to exit.
- This selects the LAN services to enable or disable (Server Config).
 1. Press **[Shift]+[P-set]**(Menu) to enter into the system menu interface.
 2. se left and right keys or rotate the voltage knob to select **SYSTEM** and press **[Enter]**key enter to system menu.
 3. se left and right keys or rotate the voltage knob to select **Communication** and press **[Enter]**key to confirm.
 4. se left and right keys or rotate the voltage knob to select **LAN** and press **[Enter]**key to confirm.
 5. se left and right keys or rotate the voltage knob to select **Server-Config** and press **[Enter]**key to confirm.

6. se left and right keys or rotate the voltage knob to select the desired service, and press **[Enter]**key to confirm.

Note

User need to set the Socket Port when select enable the Raw Socket.

7. Rotate the knob to adjust the value, and press **[Enter]**key to confirm.
 - On: indicates enable the service.
 - Off: indicates disable the service.
8. After setting, press **[Esc]** to exit.

Reset the LAN to the Default Settings

The operation steps to reset the LAN to the default settings are as follows.

1. Press **[Shift]+[P-set]**(Menu) to enter into the system menu interface.
2. se left and right keys or rotate the voltage knob to select **SYSTEM** and press **[Enter]**key enter to system menu.
3. se left and right keys or rotate the voltage knob to select **Communication** , and press **[Enter]**key to confirm.
4. se left and right keys or rotate the voltage knob to select **LAN** , and press **[Enter]**key to confirm.
5. se left and right keys or rotate the voltage knob to select **Restore** , and press **[Enter]**key to confirm.
 - NO: indicates refuse to reset the LAN to the default settings.
 - YES: indicates reset the LAN to the default settings.
6. After setting, press **[Esc]** to exit.

Confirm the LAN Setting

After configuring the LAN settings, the user need to confirm the settings to make it valid in the instrument. The operation steps to confirm the LAN settings are as follows.

1. Press **[Shift]+[P-set]**(Menu) to enter into the system menu interface.
2. se left and right keys or rotate the voltage knob to select **SYSTEM** and press **[Enter]**key enter to system menu.
3. se left and right keys or rotate the voltage knob to select **Communication** , and press **[Enter]**key to confirm.
4. se left and right keys or rotate the voltage knob to select **LAN** , and press **[Enter]**key to confirm.
5. se left and right keys or rotate the voltage knob to select **Reset** , and press **[Enter]**key to confirm.
 - NO: indicates refuse to confirm the LAN setting.
 - YES: indicates confirm the LAN setting.

6. After setting, press **[Esc]** to exit.

4.4.1 Using the Web Interface

The instrument has a built-in Web interface for monitoring and controlling the instrument via a Web browser. To use the Web interface, connect the instrument and PC over LAN and enter the instrument's IP address into the address bar at the top of your PC's Web browser, you can access the front panel control functions including the LAN configuration parameters.



Note

- Please confirm the IP address and Gateway is configured correctly. The detailed information refer to the Configure LAN Interface Information.
- You must enable Web service if you wish to remotely control your instrument using its built-in Web interface. Refer to LAN services setting for the detailed operation procedures.
- Up to six simultaneous connections are allowed. With additional connections, performance will be reduced.

As shipped, the login password of the Web interface defaults to 12345678. To change the password, click the Security button in the navigation bar on the left side of the window after login.

Enter the password and then click the LOGIN button, the Web Interface will appear in the browser as shown below. The following figure is just as an example and the Web interface of different models are different. The actual shown page shall be subject to the connected instrument.

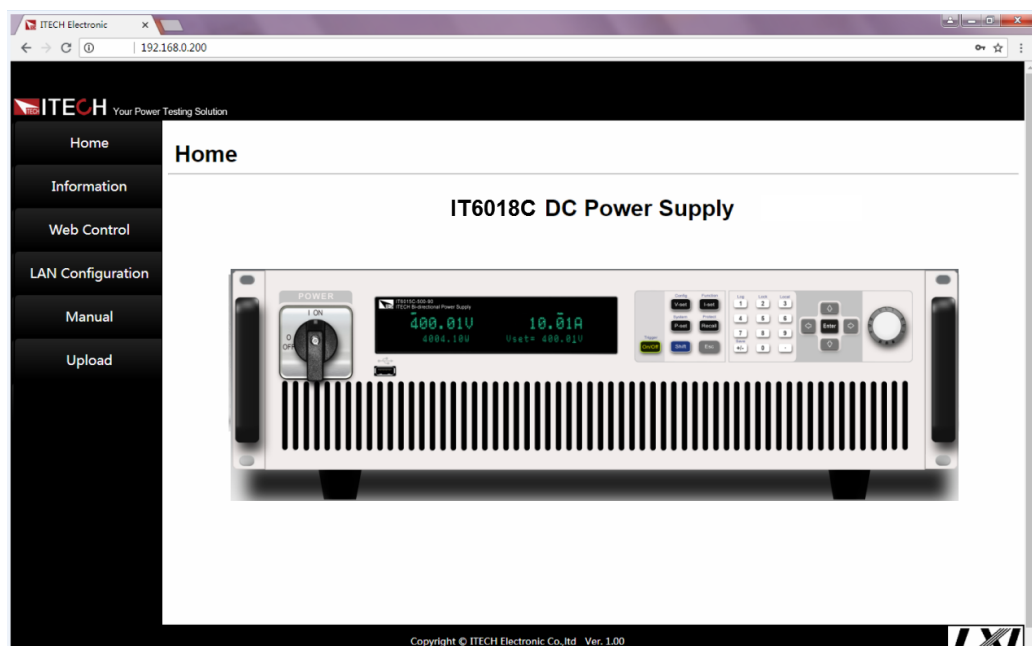

You can select different interfaces by clicking the seven buttons shown in the navigation bar on the left side of the window. The detailed descriptions are as follows.

- Home: Web home interface, displays the model and appearance of the instrument;
- Information: displays the serial number of the instrument and more system information as well as LAN configuration parameters;
- Web Control: enables the Web control to begin controlling the instrument. This page allows you to monitor and control the instrument;
- LAN Configuration: reconfigure the LAN parameters;
- Security: change the password and control access to the Web interface;
- Manual: go to the ITECH official website and view or download the relevant documents.
- Logout: logout the Web interface.

4.4.2 Using Telnet

The Telnet utility (as well as sockets), is another way to communicate with the instrument without using I/O libraries or drivers. In all cases, you must first establish a LAN connection from your computer to the instrument as previously described.

In an MS-DOS Command Prompt box, type “telnet hostname” where hostname is the instrument’s hostname or IP address. Press the Enter key and you should get a Telnet session box with a title indicating that you are connected to the instrument and 23 is the instrument’s telnet port. Type the SCPI commands at the prompt.

4.4.3 Using Sockets

CAUTION

The instruments allow any combination of up to six simultaneous socket and telnet connections to be made.

ITECH instruments have SCPI socket services, which can be used to send and receive ASCII/SCPI commands, queries, and query responses. All commands must be terminated with a newline for the message to be parsed. All query responses will also be terminated with a newline.

4.5 CAN Communication Port

There is one DB25 interface at the rear panel of power supply, and the pin definition is shown below. The user can use this terminal for PC connection; to activate connection, be sure that the values set in the System menu are same as the corresponding values set in PC.



Note

CAN setting in the program shall be consistent with the one set in the System menu of front panel. To query and change.

Baud Rate

In the front panel [Shift] + [P-set](Menu), under the System menu, the user can select one Baud rate stored in NVM: 20K|40K|50k|80k|100k|125k|150k|200k|250k|400K|500K|1000K.

CAN Pin Definition

Use DB25 interface for connection. CAN interface pin is as follows.

Pin No.	Description
H	CAN_H
L	CAN_L

CAN Troubleshooting:

If CAN connection fails, check that:

- The PC and power supply have same Baud rate.
- Appropriate interface pin or adapter is used, as described in CAN connector.
- The interface cable is correctly connected (CAN_H to CAN_H, CAN_L to CAN_L).
- Check whether 120 Ω terminal resistance is connected.

Setting Communication

Before running communication, please match the power supply parameters with the PC parameters as shown below.

Baud rate: 20K(20K|40K|50k|80k|100k|125k|150K|200k|250k|400K|500K|1000K). You can enter the System menu through panel and set the communication Baud rate.

Addr.: 1-127

Prescale (Pres): Not settable. Change with Baud rate setting.

PTS (BS1): Not settable. Change with Baud rate setting.

PBS (BS2): Not settable. Change with Baud rate setting.

Baud rate	(Prescale)	PTS	PBS
20k	150	1	6
40K	75	1	6
50K	60	1	6
80K	75	1	1
100K	30	1	6
125K	30	0	5
150K	20	6	1
200K	15	1	6
250K	15	1	5
400K	15	1	1
500K	6	1	6
1000K	3	1	6

5 Technical Specification

This chapter will introduce the main technical parameters of this power, such as rated voltage/current/power and so on. Besides, we will introduce the working environment and storage temperature.

- ◆ Main Technical Parameters
- ◆ Supplemental characteristics

5.1 Main Technical Parameters

5.1.1 IT6512C

Parameter		IT6512C Version: V1.4
Output Rating (0 °C-40 °C)	Output Voltage	0 ~ 80V
	Output Current	0 ~ 120A
	Internal Sink Current ¹	0 ~ 50A
	External Sink Current ¹	0 ~ 120A
	Output Power	0 ~ 1800W
	Internal Sink Power ¹	0 ~ 150W
	External Sink Power ¹	0 ~ 5400W
Output Resistance	Range	0 ~ 3.556Ω
	Accuracy ²	0.25%+30mΩ*A
	Resolution	0.1mΩ
Line regulation ±(% of Output+Offset)	Voltage	≤0.01%+10mV
	Current	≤0.01%+60mA
Load regulation ±(% of Output+Offset)	Voltage	≤0.01%+30mV
	Current	≤0.05%+120mA
Setup Resolution	Voltage	10mV
	Current	10mA
	Power	0.1W
Read Back Resolution	Voltage	10mV

Parameter		IT6512C Version: V1.4
	Current	10mA
	Power	0.1W
Setup Accuracy ³ (within 12 months, 25°C ±5°C) ±(% of Output+Offset)	Voltage	≤0.05%+30mV
	Current	≤0.2%+120mA
	Power	1%+30W
Read Back Accuracy ⁴ (within 12 months, 25°C ±5°C) ±(% of Output+Offset)	Voltage	≤0.05%+30mV
	Current	≤0.2%+120mA
	Power	1%+30W
Ripple (20Hz -20MHz)	Voltage	≤80mVp-p
	Current	≤0.05%+60mA _{rms}
Setup Temperature Coefficient (% of Output/°C+Offset)	Voltage	≤0.01%+30mV
	Current	≤0.02%+120mA
Read Back Temperature Coefficient (% of Output/°C+Offset)	Voltage	≤0.01%+30mV
	Current	≤0.02%+120mA
Rise time(no load) ⁵	Voltage	≤10ms
Rise time(full load) ⁵	Voltage	≤20ms
Fall time(no load) ⁵	Voltage	≤30ms
Fall time(full load) ⁵	Voltage	≤20ms
Current seamless switching ⁶	-90% ~ 90%	≤10ms
	90% ~ -90%	≤10ms
Transient Response Time	Voltage	≤3ms
AC Input ⁷	Voltage	220V±10%
	Frequency	47Hz ~ 63Hz
Setup stability-30min (% of Output +Offset)	Voltage	≤0.05%+30mV
	Current	≤0.1%+120mA
Setup stability-8h (% of Output +Offset)	Voltage	≤0.05%+30mV
	Current	≤0.1%+120mA
Readback stability-30min (% of Output +Offset)	Voltage	≤0.05%+30mV
	Current	≤0.1%+120mA
Readback stability-8h (% of Output +Offset)	Voltage	≤0.05%+30mV
	Current	≤0.1%+120mA
Efficiency	80%	

Parameter		IT6512C Version: V1.4
Remote Sense Compensation Voltage		3V
Command Response Time		20mS
Power Factor		0.99
Maximum input current ⁸		12A
Maximum input apparent power		2300VA
Storage temperature		-10°C ~ 70°C
Protective function		Source OVP, OCP, OPP and Load OCP, OPP, OTP, Vsense reversed
standard Interface		USB/RS232/CAN/GPIB/LAN
Isolation (output to ground)		500V
Series Number		≤2
Parallel Number		≤8
Parallel Number of Power Dissipater		1/2/3
Working temperature		0 ~ 40°C
Dimension (mm)		483mmW×105.4mmH×640.8mmD
Weight(net)		17Kg

5.1.2 IT6522C

Parameter		IT6522C Version: V1.4
Output Rating (0 °C-40 °C)	Output Voltage	0 ~ 80V
	Output Current	0 ~ 120A
	Internal Sink Current ¹	0 ~ 50A
	External Sink Current ¹	0 ~ 120A
	Output Power	0 ~ 3000W
	Internal Sink Power ¹	0 ~ 150W
	External Sink Power ¹	0 ~ 9000W
Output Resistance	Range	0 ~ 2.133Ω
	Accuracy ²	0.25% + 30mΩ*A
	Resolution	0.1mΩ
Line regulation ±(% of Output+Offset)	Voltage	≤0.01%+10mV

Parameter		IT6522C Version: V1.4
	Current	$\leq 0.01\% + 60\text{mA}$
Load regulation \pm (% of Output+Offset)	Voltage	$\leq 0.01\% + 30\text{mV}$
	Current	$\leq 0.05\% + 120\text{mA}$
Setup Resolution	Voltage	10mV
	Current	10mA
	Power	0.1W
Read Back Resolution	Voltage	10mV
	Current	10mA
	Power	0.1W
Setup Accuracy ³ (within 12 months, 25°C ±5°C) \pm (% of Output+Offset)	Voltage	$\leq 0.05\% + 30\text{mV}$
	Current	$\leq 0.2\% + 120\text{mA}$
	Power	1%+30W
Read Back Accuracy ⁴ (within 12 months, 25°C ±5°C) \pm (% of Output+Offset)	Voltage	$\leq 0.05\% + 30\text{mV}$
	Current	$\leq 0.2\% + 120\text{mA}$
	Power	1%+30W
Ripple (20Hz -20MHz)	Voltage	$\leq 80\text{mVp-p}$
	Current	$\leq 0.05\% + 60\text{mA}_{\text{rms}}$
Setup Temperature Coefficient (% of Output/°C+Offset)	Voltage	$\leq 0.01\% + 30\text{mV}$
	Current	$\leq 0.02\% + 120\text{mA}$
Read Back Temperature Coefficient (% of Output/°C+Offset)	Voltage	$\leq 0.01\% + 30\text{mV}$
	Current	$\leq 0.02\% + 120\text{mA}$
Rise time(no load) ⁵	Voltage	$\leq 10\text{ms}$
Rise time(full load) ⁵	Voltage	$\leq 20\text{ms}$
Fall time(no load) ⁵	Voltage	$\leq 30\text{ms}$
Fall time(full load) ⁵	Voltage	$\leq 10\text{ms}$
Current seamless switching ⁶	-90% ~ 90%	$\leq 10\text{ms}$
	90% ~ -90%	$\leq 10\text{ms}$
Transient Response Time	Voltage	$\leq 3\text{ms}$
AC Input ⁷	Voltage	220V±10%
	Frequency	47Hz ~ 63Hz
Setup stability-30min (% of Output +Offset)	Voltage	$\leq 0.05\% + 30\text{mV}$
	Current	$\leq 0.1\% + 120\text{mA}$
Setup stability-8h	Voltage	$\leq 0.05\% + 30\text{mV}$

Parameter		IT6522C Version: V1.4
(%of Output +Offset)	Current	$\leq 0.1\% + 120\text{mA}$
Readback stability-30min (%of Output +Offset)	Voltage	$\leq 0.05\% + 30\text{mV}$
	Current	$\leq 0.1\% + 120\text{mA}$
Readback stability-8h (%of Output +Offset)	Voltage	$\leq 0.05\% + 30\text{mV}$
	Current	$\leq 0.1\% + 120\text{mA}$
Efficiency	80%	
Remote Sense Compensation Voltage	3V	
Command Response Time	20mS	
Power Factor	0.99	
Maximum input current ⁸	19A	
Maximum input apparent power	3800VA	
Storage temperature	$-10^{\circ}\text{C} \sim 70^{\circ}\text{C}$	
Protective function	Source OVP, OCP, OPP and Load OCP, OPP, OTP, Vsense reversed protect	
standard Interface	USB/RS232/CAN/GPIB/LAN	
Isolation (output to ground)	500V	
Series Number	≤ 2	
Parallel Number	≤ 8	
Parallel Number of Power Dissipater	1/2/3	
Working temperature	$0 \sim 40^{\circ}\text{C}$	
Dimension (mm)	483mmW×105.4mmH×640.8mmD	
Weight(net)	17Kg	

5.1.3 IT6532C

Parameter		IT6532C Version: V1.4
Output Rating (0 °C-40 °C)	Output Voltage	0 ~ 80V
	Output Current	0 ~ 240A
	Internal Sink Current ¹	0 ~ 100A

Parameter		IT6532C Version: V1.4
	External Sink Current ¹	0 ~ 240A
	Output Power	0 ~ 6KW
	Internal Sink Power ¹	0 ~ 300W
	External Sink Power ¹	0 ~ 18KW
Output Resistance	Range	0 ~ 1.067Ω
	Accuracy ²	0.25%+30mΩ*A
	Resolution	0.1mΩ
Line regulation ±(% of Output+Offset)	Voltage	≤0.01%+10mV
	Current	≤0.01%+120mA
Load regulation ±(% of Output+Offset)	Voltage	≤0.01%+30mV
	Current	≤0.05%+240mA
Setup Resolution	Voltage	10mV
	Current	100mA
	Power	0.1W
Read Back Resolution	Voltage	10mV
	Current	100mA
	Power	0.1W
Setup Accuracy ³ (within 12 months, 25°C ±5°C) ±(% of Output+Offset)	Voltage	≤0.05%+30mV
	Current	≤0.2%+240mA
	Power	1%+60W
Read Back Accuracy ⁴ (within 12 months, 25°C ±5°C) ±(% of Output+Offset)	Voltage	≤0.05%+30mV
	Current	≤0.2%+240mA
	Power	1%+60W
Ripple (20Hz -20MHz)	Voltage	≤80mVp-p
	Current	≤0.05%+120mArms
Setup Temperature Coefficient (% of Output/°C+Offset)	Voltage	≤0.01%+30mV
	Current	≤0.02%+240mA
Read Back Temperature Coefficient (% of Output/°C+Offset)	Voltage	≤0.01%+30mV
	Current	≤0.02%+240mA
Rise time(no load) ⁵	Voltage	≤10ms
Rise time(full load) ⁵	Voltage	≤20ms

Parameter		IT6532C Version: V1.4
Fall time(no load) ⁵	Voltage	≤30ms
Fall time(full load) ⁵	Voltage	≤10ms
Current seamless switching ⁶	-90% ~ 90%	≤20ms
	90% ~ -90%	≤20ms
Transient Response Time	Voltage	≤3ms
AC Input ⁷	Voltage	220V±10%
	Frequency	47Hz ~ 63Hz
Setup stability-30min (%of Output +Offset)	Voltage	≤0.05%+30mV
	Current	≤0.1%+240mA
Setup stability-8h (%of Output +Offset)	Voltage	≤0.05%+30mV
	Current	≤0.1%+240mA
Readback stability-30min (%of Output +Offset)	Voltage	≤0.05%+30mV
	Current	≤0.1%+240mA
Readback stability-8h (%of Output +Offset)	Voltage	≤0.05%+30mV
	Current	≤0.1%+240mA
Efficiency	80%	
Remote Sense Compensation Voltage	3V	
Command Response Time	20mS	
Power Factor	0.99	
Maximum input current ⁸	38A	
Maximum input apparent power	7600VA	
Storage temperature	-10°C ~ 70°C	
Protective function	Source OVP, OCP, OPP and Load OCP, OPP, OTP, Vsense reversed	
standard Interface	USB/RS232/CAN/GPIB/LAN	
Isolation (output to ground)	500V	
Series Number	≤2	
Parallel Number	≤8	
Parallel Number of Power Dissipater	2/4/6	
Working temperature	0 ~ 40°C	

Parameter		IT6532C Version: V1.4
Dimension (mm)	483mmW×194mmH×640.8mmD	
Weight(net)	35Kg	

5.1.4 IT6542C

Parameter		IT6542C Version: V1.4
Output Rating (0 °C-40 °C)	Output Voltage	0 ~ 80V
	Output Current	0 ~ 360A
	Internal Sink Current ¹	0 ~ 150A
	External Sink Current ¹	0 ~ 360A
	Output Power	0 ~ 9KW
	Internal Sink Power ¹	0 ~ 450W
	External Sink Power ¹	0 ~ 27KW
Output Resistance	Range	0 ~ 0.711Ω
	Accuracy ²	0.25%+30mΩ*A
	Resolution	0.1mΩ
Line regulation ±(% of Output+Offset)	Voltage	≤0.01%+10mV
	Current	≤0.01%+180mA
Load regulation ±(% of Output+Offset)	Voltage	≤0.01%+30mV
	Current	≤0.05%+360mA
Setup Resolution	Voltage	10mV
	Current	100mA
	Power	0.1W
Read Back Resolution	Voltage	10mV
	Current	100mA
	Power	0.1W
Setup Accuracy ³ (within 12 months, 25°C ±5°C) ±(% of Output+Offset)	Voltage	≤0.05%+30mV
	Current	≤0.2%+360mA
	Power	1%+90W
Read Back Accuracy ⁴	Voltage	≤0.05%+30mV

Parameter		IT6542C Version: V1.4
(within 12 months, 25°C ±5°C) ±(% of Output+Offset)	Current	≤0.2%+360mA
	Power	1%+90W
Ripple (20Hz -20MHz)	Voltage	≤80mVp-p
	Current	≤0.05%+180mArms
Setup Temperature Coefficient (% of Output/°C+Offset)	Voltage	≤0.01%+30mV
	Current	≤0.02%+360mA
Read Back Temperature Coefficient (% of Output/°C+Offset)	Voltage	≤0.01%+30mV
	Current	≤0.02%+360mA
Rise time(no load) ⁵	Voltage	≤10ms
Rise time(full load) ⁵	Voltage	≤20ms
Fall time(no load) ⁵	Voltage	≤30ms
Fall time(full load) ⁵	Voltage	≤10ms
Current seamless switching ⁶	-90% ~ 90%	≤30ms
	90% ~ -90%	≤30ms
Transient Response Time	Voltage	≤3ms
AC Input ⁷	Voltage	220Vac±10%
	Frequency	47Hz ~ 63Hz
Setup stability-30min (% of Output +Offset)	Voltage	≤0.05%+30mV
	Current	≤0.1%+360mA
Setup stability-8h (% of Output +Offset)	Voltage	≤0.05%+30mV
	Current	≤0.1%+360mA
Readback stability-30min (% of Output +Offset)	Voltage	≤0.05%+30mV
	Current	≤0.1%+360mA
Readback stability-8h (% of Output +Offset)	Voltage	≤0.05%+30mV
	Current	≤0.1%+360mA
Efficiency	80%	
Remote Sense Compensation Voltage	3V	
Command Response Time	20mS	
Power Factor	0.99	
Maximum input current ⁸	19A	
Maximum input apparent power	11400VA	

Parameter	IT6542C Version: V1.4
Storage temperature	-10°C ~ 70°C
Protective function	Source OVP, OCP, OPP and Load OCP, OPP, OTP, Vsense reversed
standard Interface	USB/RS232/CAN/GPIB/LAN
Isolation (output to ground)	500V
Series Number	≤2
Parallel Number	≤8
Parallel Number of Power Dissipater	3/6/9
Working temperature	0 ~ 40°C
Dimension (mm)	483mmW×283.2mmH×640.8mmD
Weight(net)	53Kg

5.1.5 IT6552C

Parameter	IT6552C Version: V1.4	
Output Rating(0 °C-40 °C)	Output Voltage	0 ~ 80V
	Output Current	0 ~ 480A
	Internal Sink Current ¹	0 ~ 200A
	External Sink Current ¹	0 ~ 480A
	Output Power	0 ~ 12KW
	Internal Sink Power ¹	0 ~ 600W
	External Sink Power ¹	0 ~ 36KW
Output Resistance	Range	0 ~ 0.133Ω
	Accuracy ²	0.25%+30mΩ*A
	Resolution	0.1mΩ
Line regulation ±(% of Output+Offset)	Voltage	≤0.01%+10mV
	Current	≤0.01%+240mA
Load regulation ±(% of Output+Offset)	Voltage	≤0.01%+30mV
	Current	≤0.05%+480mA

Parameter		IT6552C Version: V1.4
Setup Resolution	Voltage	10mV
	Current	100mA
	Power	0.1W
Read Back Resolution	Voltage	10mV
	Current	100mA
	Power	0.1W
Setup Accuracy ³ (within 12 months, 25°C ±5°C) ±(% of Output+Offset)	Voltage	≤0.05%+30mV
	Current	≤0.2%+480mA
	Power	1%+120W
Read Back Accuracy ⁴ (within 12 months, 25°C ±5°C) ±(% of Output+Offset)	Voltage	≤0.05%+30mV
	Current	≤0.2%+480mA
	Power	1%+120W
Ripple (20Hz -20MHz)	Voltage	≤80mVp-p
	Current	≤0.05%+240mArms
Setup Temperature Coefficient (% of Output/°C+Offset)	Voltage	≤0.01%+30mV
	Current	≤0.02%+480mA
Read Back Temperature Coefficient (% of Output/°C+Offset)	Voltage	≤0.01%+30mV
	Current	≤0.02%+480mA
Rise time(no load) ⁵	Voltage	≤10ms
Rise time(full load) ⁵	Voltage	≤20ms
Fall time(no load) ⁵	Voltage	≤30ms
Fall time(full load) ⁵	Voltage	≤10ms
Current seamless switching ⁶	-90% ~ 90%	≤40ms
	90% ~ -90%	≤40ms
Transient Response Time	Voltage	≤3ms
AC Input ⁷	Voltage	380Vac±10%(Three-phase five wire)
	Frequency	47Hz ~ 63Hz
Setup stability-30min (% of Output +Offset)	Voltage	≤0.05%+30mV
	Current	≤0.1%+480mA
Setup stability-8h (% of Output +Offset)	Voltage	≤0.05%+30mV
	Current	≤0.1%+480mA
Readback stability-30min (% of Output +Offset)	Voltage	≤0.05%+30mV

Parameter		IT6552C Version: V1.4
	Current	$\leq 0.1\% + 480\text{mA}$
Readback stability-8h (%of Output +Offset)	Voltage	$\leq 0.05\% + 30\text{mV}$
	Current	$\leq 0.1\% + 480\text{mA}$
Efficiency		80%
Remote Sense Compensation Voltage		3V
Command Response Time		20mS
Power Factor		0.99
Maximum input current ⁸		38A
Maximum input apparent power		15200VA
Storage temperature		-10°C ~ 70°C
Protective function		Source OVP, OCP, OPP and Load OCP, OPP, OTP, Vsense reversed
standard Interface		USB/RS232/CAN/GPIB/LAN
Isolation (output to ground)		500V
Series Number		≤ 2
Parallel Number		≤ 8
Parallel Number of Power Dissipater		4/8/12
Working temperature		0 ~ 40°C
Dimension (mm)		554mmW×902mmH×807.5mmD(ITECH 15UCabinet)
Weight(net)		119KG

5.1.6 IT6562C

Parameter		IT6562C Version: V1.4
Output Rating (0 °C-40 °C)	Output Voltage	0 ~ 80V
	Output Current	0 ~ 600A
	Internal Sink Current ¹	0 ~ 250A
	External Sink Current ¹	0 ~ 600A
	Output Power	0 ~ 15KW

Parameter		IT6562C Version: V1.4
	Internal Sink Power ¹	0 ~ 750W
	External Sink Power ¹	0 ~ 45KW
Output Resistance	Range	0 ~ 0.107Ω
	Accuracy ²	0.25%+30mΩ*A
	Resolution	0.1mΩ
Line regulation ±(%of Output+Offset)	Voltage	≤0.01%+10mV
	Current	≤0.01%+300mA
Load regulation ±(%of Output+Offset)	Voltage	≤0.01%+30mV
	Current	≤0.05%+600mA
Setup Resolution	Voltage	10mV
	Current	100mA
	Power	0.1W
Read Back Resolution	Voltage	10mV
	Current	100mA
	Power	0.1W
Setup Accuracy ³ (within 12 months, 25°C ±5°C) ±(%of Output+Offset)	Voltage	≤0.05%+30mV
	Current	≤0.2%+600mA
	Power	1%+150W
Read Back Accuracy ⁴ (within 12 months, 25°C ±5°C) ±(%of Output+Offset)	Voltage	≤0.05%+30mV
	Current	≤0.2%+600mA
	Power	1%+150W
Ripple (20Hz -20MHz)	Voltage	≤80mVp-p
	Current	≤0.05%+300mArms
Setup Temperature Coefficient (%of Output/°C+Offset)	Voltage	≤0.01%+30mV
	Current	≤0.02%+600mA
Read Back Temperature Coefficient (%of Output/°C+Offset)	Voltage	≤0.01%+30mV
	Current	≤0.02%+600mA
Rise time(no load) ⁵	Voltage	≤10ms
Rise time(full load) ⁵	Voltage	≤20ms
Fall time(no load) ⁵	Voltage	≤30ms
Fall time(full load) ⁵	Voltage	≤10ms

Parameter		IT6562C Version: V1.4
Current seamless switching ⁶	-90% ~ 90%	≤50ms
	90% ~ -90%	≤50ms
Transient Response Time	Voltage	≤3ms
AC Input ⁷	Voltage	380Vac±10%(Three-phase five wire)
	Frequency	47Hz ~ 63Hz
Setup stability-30min (%of Output +Offset)	Voltage	≤0.05%+30mV
	Current	≤0.1%+600mA
Setup stability-8h (%of Output +Offset)	Voltage	≤0.05%+30mV
	Current	≤0.1%+600mA
Readback stability-30min (%of Output +Offset)	Voltage	≤0.05%+30mV
	Current	≤0.1%+600mA
Readback stability-8h (%of Output +Offset)	Voltage	≤0.05%+30mV
	Current	≤0.1%+600mA
Efficiency	80%	
Remote Sense Compensation Voltage	3V	
Command Response Time	20mS	
Power Factor	0.99	
Maximum input current ⁸	38A	
Maximum input apparent power	19000VA	
Storage temperature	-10°C ~ 70°C	
Protective function	Source OVP, OCP, OPP and Load OCP, OPP, OTP, Vsense reversed	
standard Interface	USB/RS232/CAN/GPIB/LAN	
Isolation (output to ground)	500V	
Series Number	≤2	
Parallel Number	≤8	
Parallel Number of Power Dissipater	5/10/15	
Working temperature	0 ~ 40°C	
Dimension (mm)	554mmW×902mmH×807.5mmD (ITECH 15UCabinet)	
Weight(net)	137Kg	

5.1.7 IT6572C

Parameter		IT6572C Version: V1.4
Output Rating (0 °C-40 °C)	Output Voltage	0 ~ 80V
	Output Current	0 ~ 840A
	Internal Sink Current ¹	0 ~ 350A
	External Sink Current ¹	0 ~ 840A
	Output Power	0 ~ 21KW
	Internal Sink Power ¹	0 ~ 1050W
	External Sink Power ¹	0 ~ 63KW
Output Resistance	Range	0 ~ 0.076Ω
	Accuracy ²	0.25%+30mΩ*A
	Resolution	0.1mΩ
Line regulation ±(% of Output+Offset)	Voltage	≤0.01%+10mV
	Current	≤0.01%+420mA
Load regulation ±(% of Output+Offset)	Voltage	≤0.01%+30mV
	Current	≤0.05%+840mA
Setup Resolution	Voltage	10mV
	Current	100mA
	Power	0.1W
Read Back Resolution	Voltage	10mV
	Current	100mA
	Power	0.1W
Setup Accuracy ³ (within 12 months, 25°C ±5°C) ±(% of Output+Offset)	Voltage	≤0.05%+30mV
	Current	≤0.2%+840mA
	Power	1%+210W
Read Back Accuracy ⁴ (within 12 months, 25°C ±5°C) ±(% of Output+Offset)	Voltage	≤0.05%+30mV
	Current	≤0.2%+840mA
	Power	1%+210W
Ripple (20Hz -20MHz)	Voltage	≤80mVp-p
	Current	≤0.05%+420mArms
Setup Temperature Coefficient	Voltage	≤0.01%+30mV

Parameter		IT6572C Version: V1.4
(%of Output/°C+Offset)	Current	$\leq 0.02\% + 840\text{mA}$
Read Back Temperature Coefficient (%of Output/°C+Offset)	Voltage	$\leq 0.01\% + 30\text{mV}$
	Current	$\leq 0.02\% + 840\text{mA}$
Rise time(no load) ⁵	Voltage	$\leq 10\text{ms}$
Rise time(full load) ⁵	Voltage	$\leq 20\text{ms}$
Fall time(no load) ⁵	Voltage	$\leq 30\text{ms}$
Fall time(full load) ⁵	Voltage	$\leq 10\text{ms}$
Current seamless switching ⁶	-90% ~ 90%	$\leq 70\text{ms}$
	90% ~ -90%	$\leq 70\text{ms}$
Transient Response Time	Voltage	$\leq 3\text{ms}$
AC Input ⁷	Voltage	380Vac $\pm 10\%$ (Three-phase five wire)
	Frequency	47Hz ~ 63Hz
Setup stability-30min (%of Output +Offset)	Voltage	$\leq 0.05\% + 30\text{mV}$
	Current	$\leq 0.1\% + 840\text{mA}$
Setup stability-8h (%of Output +Offset)	Voltage	$\leq 0.05\% + 30\text{mV}$
	Current	$\leq 0.1\% + 840\text{mA}$
Readback stability-30min (%of Output +Offset)	Voltage	$\leq 0.05\% + 30\text{mV}$
	Current	$\leq 0.1\% + 840\text{mA}$
Readback stability-8h (%of Output +Offset)	Voltage	$\leq 0.05\% + 30\text{mV}$
	Current	$\leq 0.1\% + 840\text{mA}$
Efficiency	80%	
Remote Sense Compensation Voltage	3V	
Command Response Time	20mS	
Power Factor	0.99	
Maximum input current ⁸	57A	
Maximum input apparent power	26600VA	
Storage temperature	$-10^{\circ}\text{C} \sim 70^{\circ}\text{C}$	
Protective function	Source OVP, OCP, OPP and Load OCP, OPP, OTP, Vsense reversed	
standard Interface	USB/RS232/CAN/GPIB/LAN	
Isolation (output to ground)	500V	

Parameter		IT6572C Version: V1.4
Series Number		≤2
Parallel Number		≤8
Parallel Number of Power Dissipater		7/14/21
Working temperature		0 ~ 40°C
Dimension (mm)	550mmW×1289.3mmH×834.8mmD (ITECH 24UCabinet)	
Weight(net)	230Kg	

5.1.8 IT6582C

Parameter		IT6582C Version: V1.4
Output Rating (0 °C-40 °C)	Output Voltage	0 ~ 80V
	Output Current	0 ~ 960A
	Internal Sink Current ¹	0 ~ 400A
	External Sink Current ¹	0 ~ 960A
	Output Power	0 ~ 24KW
	Internal Sink Power ¹	0 ~ 1200W
	External Sink Power ¹	0 ~ 72KW
Output Resistance	Range	0 ~ 0.067Ω
	Accuracy ²	0.25%+30mΩ*A
	Resolution	0.1mΩ
Line regulation	Voltage	≤0.01%+10mV
±(%of Output+Offset)	Current	≤0.01%+480mA
Load regulation	Voltage	≤0.01%+30mV
±(%of Output+Offset)	Current	≤0.05%+960mA
Setup Resolution	Voltage	10mV
	Current	100mA
	Power	0.1W
Read Back Resolution	Voltage	10mV
	Current	100mA

Parameter		IT6582C Version: V1.4
	Power	0.1W
Setup Accuracy ³ (within 12 months, 25°C ±5°C) ±(% of Output+Offset)	Voltage	≤0.05%+30mV
	Current	≤0.2%+960mA
	Power	1%+240W
Read Back Accuracy ⁴ (within 12 months, 25°C ±5°C) ±(% of Output+Offset)	Voltage	≤0.05%+30mV
	Current	≤0.2%+960mA
	Power	1%+240W
Ripple (20Hz -20MHz)	Voltage	≤80mVp-p
	Current	≤0.05%+480mArms
Setup Temperature Coefficient (% of Output/°C+Offset)	Voltage	≤0.01%+30mV
	Current	≤0.02%+960mA
Read Back Temperature Coefficient (% of Output/°C+Offset)	Voltage	≤0.01%+30mV
	Current	≤0.02%+960mA
Rise time(no load) ⁵	Voltage	≤10ms
Rise time(full load) ⁵	Voltage	≤20ms
Fall time(no load) ⁵	Voltage	≤30ms
Fall time(full load) ⁵	Voltage	≤10ms
Current seamless switching ⁶	-90% ~ 90%	≤80ms
	90% ~ -90%	≤80ms
Transient Response Time	Voltage	≤3ms
AC Input ⁷	Voltage	380Vac±10%(Three-phase five wire)
	Frequency	47Hz ~ 63Hz
Setup stability-30min (% of Output +Offset)	Voltage	≤0.05%+30mV
	Current	≤0.1%+960mA
Setup stability-8h (% of Output +Offset)	Voltage	≤0.05%+30mV
	Current	≤0.1%+960mA
Readback stability-30min (% of Output +Offset)	Voltage	≤0.05%+30mV
	Current	≤0.1%+960mA
Readback stability-8h (% of Output +Offset)	Voltage	≤0.05%+30mV
	Current	≤0.1%+960mA
Efficiency		80%
Remote Sense Compensation Voltage		3V

Parameter		IT6582C Version: V1.4
Command Response Time		20mS
Power Factor		0.99
Maximum input current ⁸		57A
Maximum input apparent power		30400VA
Storage temperature		-10°C ~ 70°C
Protective function		Source OVP, OCP, OPP and Load OCP, OPP, OTP, Vsense reversed
standard Interface		USB/RS232/CAN/GPIB/LAN
Isolation (output to ground)		500V
Series Number		≤2
Parallel Number		≤8
Parallel Number of Power Dissipater		8/16/24
Working temperature		0 ~ 40°C
Dimension (mm)		550mmW×1289.3mmH×834.8mmD
Weight(net)		248Kg

5.1.9 IT6592C

Parameter		IT6592C Version: V1.4
Output Rating (0 °C-40 °C)	Output Voltage	0 ~ 80V
	Output Current	0 ~ 1200A
	Internal Sink Current ¹	0 ~ 500A
	External Sink Current ¹	0 ~ 1200A
	Output Power	0 ~ 30KW
	Internal Sink Power ¹	0 ~ 1500W
	External Sink Power ¹	0 ~ 90KW
Output Resistance	Range	0 ~ 0.053Ω
	Accuracy ²	0.25%+30mΩ*A
	Resolution	0.1mΩ
Line regulation ±(% of Output+Offset)	Voltage	≤0.01%+10mV
	Current	≤0.01%+600mA
Load regulation	Voltage	≤0.01%+30mV

Parameter		IT6592C Version: V1.4
±(% of Output+Offset)	Current	≤0.05%+1200mA
Setup Resolution	Voltage	10mV
	Current	100mA
	Power	0.1W
Read Back Resolution	Voltage	10mV
	Current	100mA
	Power	0.1W
Setup Accuracy ³ (within 12 months, 25°C ±5°C) ±(% of Output+Offset)	Voltage	≤0.05%+30mV
	Current	≤0.2%+1200mA
	Power	1%+300W
Read Back Accuracy ⁴ (within 12 months, 25°C ±5°C) ±(% of Output+Offset)	Voltage	≤0.05%+30mV
	Current	≤0.2%+1200mA
	Power	1%+300W
Ripple (20Hz -20MHz)	Voltage	≤80mVp-p
	Current	≤0.05%+600mArms
Setup Temperature Coefficient (% of Output/°C+Offset)	Voltage	≤0.01%+30mV
	Current	≤0.02%+1200mA
Read Back Temperature Coefficient (% of Output/°C+Offset)	Voltage	≤0.01%+30mV
	Current	≤0.02%+1200mA
Rise time(no load) ⁵	Voltage	≤10ms
Rise time(full load) ⁵	Voltage	≤20ms
Fall time(no load) ⁵	Voltage	≤30ms
Fall time(full load) ⁵	Voltage	≤10ms
Current seamless switching ⁶	-90% ~ 90%	≤100ms
	90% ~ -90%	≤100ms
Transient Response Time	Voltage	≤3ms
AC Input ⁷	Voltage	380Vac±10%(Three-phase five wire)
	Frequency	47Hz ~ 63Hz
Setup stability-30min (% of Output +Offset)	Voltage	≤0.05%+30mV
	Current	≤0.1%+1200mA
Setup stability-8h (% of Output +Offset)	Voltage	≤0.05%+30mV
	Current	≤0.1%+1200mA

Parameter		IT6592C Version: V1.4
Readback stability-30min (%of Output +Offset)	Voltage	$\leq 0.05\% + 30\text{mV}$
	Current	$\leq 0.1\% + 1200\text{mA}$
Readback stability-8h (%of Output +Offset)	Voltage	$\leq 0.05\% + 30\text{mV}$
	Current	$\leq 0.1\% + 1200\text{mA}$
Efficiency	80%	
Remote Sense Compensation Voltage	3V	
Command Response Time	20mS	
Power Factor	0.99	
Maximum input current ⁸	76A	
Maximum input apparent power	38000VA	
Storage temperature	$-10^{\circ}\text{C} \sim 70^{\circ}\text{C}$	
Protective function	Source OVP, OCP, OPP and Load OCP, OPP, OTP, Vsense reversed	
standard Interface	USB/RS232/CAN/GPIB/LAN	
Isolation (output to ground)	500V	
Series Number	≤ 2	
Parallel Number	≤ 8	
Parallel Number of Power Dissipater	10/20/30	
Working temperature	$0 \sim 40^{\circ}\text{C}$	
Dimension (mm)	550mmW×1289.3mmH×834.8mmD	
Weight(net)	284Kg	

5.1.10 IT6513C

Parameter		IT6513C Version: V1.4
Output Rating (0 °C-40 °C)	Output Voltage	0 ~ 200V
	Output Current	0 ~ 60A
	Internal Sink Current ¹	0 ~ 25A
	External Sink Current ¹	0 ~ 60A
	Output Power	0 ~ 1800W

Parameter		IT6513C Version: V1.4
	Internal Sink Power ¹	0 ~ 150W
	External Sink Power ¹	0 ~ 5400W
Output Resistance	Range	0 ~ 22.222Ω
	Accuracy ²	0.25%+100mΩ
	Resolution	1mΩ
Line regulation ±(% of Output+Offset)	Voltage	≤0.01%+20mV
	Current	≤0.01%+30mA
Load regulation ±(% of Output+Offset)	Voltage	≤0.01%+50mV
	Current	≤0.05%+60mA
Setup Resolution	Voltage	10mV
	Current	10mA
	Power	0.1W
Read Back Resolution	Voltage	10mV
	Current	10mA
	Power	0.1W
Setup Accuracy (within 12 months, 25°C ±5°C) ±(% of Output+Offset)	Voltage	≤0.05%+100mV
	Current	≤0.2%+60mA
	Power	≤1%+30W
Read Back Accuracy (within 12 months, 25°C ±5°C) ±(% of Output+Offset)	Voltage	≤0.05%+100mV
	Current	≤0.2%+60mA
	Power	≤1%+30W
Ripple (20Hz -20MHz)	Voltage	≤200mVp-p
	Current	≤50mArms
Setup Temperature Coefficient (% of Output/°C+Offset)	Voltage	≤0.05 %+100mV
	Current	≤0.2%+60mA
Read Back Temperature Coefficient (% of Output/°C+Offset)	Voltage	≤0.05%+100mV
	Current	≤0.2%+60mA
Rise time(no load) ⁵	Voltage	≤15ms
Rise time(full load) ⁵	Voltage	≤30ms
Fall time(no load) ⁵	Voltage	≤50ms
Fall time(full load) ⁵	Voltage	≤30ms
Current seamless switching ⁶	-90% ~ 90%	≤10ms
	90% ~ -90%	≤10ms

Parameter		IT6513C Version: V1.4
Transient Response Time	Voltage	≤2ms
AC Input ⁷	Voltage	220V±10%
	Frequency	47Hz ~ 63Hz
Setup stability-30min (%of Output +Offset)	Voltage	≤0.05%+100mV
	Current	≤0.2%+60mA
Setup stability-8h (%of Output +Offset)	Voltage	≤0.05%+100mV
	Current	≤0.2%+60mA
Readback stability-30min (%of Output +Offset)	Voltage	≤0.05%+100mV
	Current	≤0.2%+60mA
Readback stability-8h (%of Output +Offset)	Voltage	≤0.05%+100mV
	Current	≤0.2%+60mA
Efficiency	89%(30V/60A) ~ 90.5%(200V/9A)	
Remote Sense Compensation Voltage	2V	
Command Response Time	20mS	
Power Factor	0.99	
Maximum input current ⁸	10A	
Maximum input apparent power	2100VA	
Storage temperature	-10°C ~ 70°C	
Protective function	Source OVP, OCP, OPP and Load OCP, OPP, OTP, Vsense reversed	
standard Interface	USB/RS232/CAN/GPIB/LAN	
Isolation (output to ground)	500V	
Series Number	≤2	
Parallel Number	≤8	
Parallel Number of Power Dissipater	1/2/3	
Working temperature	0 ~ 40°C	
Dimension (mm)	483mmW×105.4mmH×640.8mmD	
Weight(net)	17Kg	

5.1.11 IT6523C

Parameter		IT6523C Version: V1.4
Output Rating (0 °C-40 °C)	Output Voltage	0 ~ 200V
	Output Current	0 ~ 60A
	Internal Sink Current ¹	0 ~ 25A
	External Sink Current ¹	0 ~ 60A
	Output Power	0 ~ 3000W
	Internal Sink Power ¹	0 ~ 150W
	External Sink Power ¹	0 ~ 9KW
Output Resistance	Range	0 ~ 13Ω
	Accuracy ²	0.25%+100mΩ
	Resolution	1mΩ
Line regulation ±(% of Output+Offset)	Voltage	≤0.01%+20mV
	Current	≤0.01%+30mA
Load regulation ±(% of Output+Offset)	Voltage	≤0.01%+50mV
	Current	≤0.05%+60mA
Setup Resolution	Voltage	10mV
	Current	10mA
	Power	0.1W
Read Back Resolution	Voltage	10mV
	Current	10mA
	Power	0.1W
Setup Accuracy (within 12 months, 25°C ±5°C) ±(% of Output+Offset)	Voltage	≤0.05%+100mV
	Current	≤0.2%+60mA
	Power	≤1%+30W
Read Back Accuracy (within 12 months, 25°C ±5°C) ±(% of Output+Offset)	Voltage	≤0.05%+100mV
	Current	≤0.2%+60mA
	Power	≤1%+30W
Ripple (20Hz -20MHz)	Voltage	≤200mVp-p
	Current	≤50mArms
Setup Temperature Coefficient (% of Output/°C+Offset)	Voltage	≤0.05 %+100mV
	Current	≤0.2%+60mA
Read Back Temperature Coefficient (% of Output/°C+Offset)	Voltage	≤0.05%+100mV
	Current	≤0.2%+60mA

Parameter		IT6523C Version: V1.4
Rise time(no load) ⁵	Voltage	≤15ms
Rise time(full load) ⁵	Voltage	≤30ms
Fall time(no load) ⁵	Voltage	≤50ms
Fall time(full load) ⁵	Voltage	≤15ms
Current seamless switching ⁶	-90% ~ 90%	≤10ms
	90% ~ -90%	≤10ms
Transient Response Time	Voltage	≤2ms
AC Input ⁷	Voltage	220V±10%
	Frequency	47Hz ~ 63Hz
Setup stability-30min (%of Output +Offset)	Voltage	≤0.05%+100mV
	Current	≤0.2%+60mA
Setup stability-8h (%of Output +Offset)	Voltage	≤0.05%+100mV
	Current	≤0.2%+60mA
Readback stability-30min (%of Output +Offset)	Voltage	≤0.05%+100mV
	Current	≤0.2%+60mA
Readback stability-8h (%of Output +Offset)	Voltage	≤0.05%+100mV
	Current	≤0.2%+60mA
Efficiency	89%(50V/60A) ~ 90.5%(200V/15A)	
Remote Sense Compensation Voltage	2V	
Command Response Time	20mS	
Power Factor	0.99	
Maximum input current ⁸	19A	
Maximum input apparent power	3800VA	
Storage temperature	-10°C ~ 70°C	
Protective function	Source OVP, OCP, OPP and Load OCP, OPP, OTP, Vsense reversed	
standard Interface	USB/RS232/CAN/GPIB/LAN	
Isolation (output to ground)	500V	
Series Number	≤2	
Parallel Number	≤8	
Parallel Number of Power Dissipater	1/2/3	

Parameter		IT6523C Version: V1.4
Working temperature	0 ~ 40°C	
Dimension (mm)	483mmW×105.4mmH×640.8mmD	
Weight(net)	17Kg	

5.1.12 IT6533C

Parameter		IT6533C Version: V1.4
Output Rating (0 °C-40 °C)	Output Voltage	0 ~ 200V
	Output Current	0 ~ 120A
	Internal Sink Current ¹	0 ~ 50A
	External Sink Current ¹	0 ~ 120A
	Output Power	0 ~ 6KW
	Internal Sink Power ¹	0 ~ 300W
	External Sink Power ¹	0 ~ 18KW
Output Resistance	Range	0 ~ 6.666Ω
	Accuracy ²	0.25%+100mΩ
	Resolution	1mΩ
Line regulation ±(% of Output+Offset)	Voltage	≤0.01%+20mV
	Current	≤0.01%+60mA
Load regulation ±(% of Output+Offset)	Voltage	≤0.01%+50mV
	Current	≤0.05%+120mA
Setup Resolution	Voltage	10mV
	Current	10mA
	Power	0.1W
Read Back Resolution	Voltage	10mV
	Current	10mA
	Power	0.1W
Setup Accuracy (within 12 months, 25°C ±5°C) ±(% of Output+Offset)	Voltage	≤0.05%+100mV
	Current	≤0.2%+120mA
	Power	≤1%+60W
Read Back Accuracy	Voltage	≤0.05%+100mV

Parameter		IT6533C Version: V1.4
(within 12 months, 25°C ±5°C) ±(% of Output+Offset)	Current	≤0.2%+120mA
	Power	≤1%+60W
Ripple (20Hz -20MHz)	Voltage	≤200mVp-p
	Current	≤100mArms
Setup Temperature Coefficient (% of Output/°C+Offset)	Voltage	≤0.05 %+100mV
	Current	≤0.2%+120mA
Read Back Temperature Coefficient (% of Output/°C+Offset)	Voltage	≤0.05%+100mV
	Current	≤0.2%+120mA
Rise time(no load) ⁵	Voltage	≤15ms
Rise time(full load) ⁵	Voltage	≤30ms
Fall time(no load) ⁵	Voltage	≤50ms
Fall time(full load) ⁵	Voltage	≤15ms
Current seamless switching ⁶	-90% ~ 90%	≤20ms
	90% ~ -90%	≤20ms
Transient Response Time	Voltage	≤2ms
AC Input ⁷	Voltage	220V±10%
	Frequency	47Hz ~ 63Hz
Setup stability-30min (% of Output +Offset)	Voltage	≤0.05%+100mV
	Current	≤0.2%+120mA
Setup stability-8h (% of Output +Offset)	Voltage	≤0.05%+100mV
	Current	≤0.2%+120mA
Readback stability-30min (% of Output +Offset)	Voltage	≤0.05%+100mV
	Current	≤0.2%+120mA
Readback stability-8h (% of Output +Offset)	Voltage	≤0.05%+100mV
	Current	≤0.2%+120mA
Efficiency	89%(50V/120A) ~ 90.5%(200V/30A)	
Remote Sense Compensation Voltage	2V	
Command Response Time	20mS	
Power Factor	0.99	
Maximum input current ⁸	38A	
Maximum input apparent power	7600VA	

Parameter	IT6533C Version: V1.4
Storage temperature	-10°C ~ 70°C
Protective function	Source OVP, OCP, OPP and Load OCP, OPP, OTP, Vsense reversed
standard Interface	USB/RS232/CAN/GPIB/LAN
Isolation (output to ground)	500V
Series Number	≤2
Parallel Number	≤8
Parallel Number of Power Dissipater	2/4/6
Working temperature	0 ~ 40°C
Dimension (mm)	483mmW×194mmH×640.8mmD
Weight(net)	35Kg

5.1.13 IT6543C

Parameter	IT6543C Version: V1.4	
Output Rating (0 °C-40 °C)	Output Voltage	0 ~ 200V
	Output Current	0 ~ 180A
	Internal Sink Current ¹	0 ~ 75A
	External Sink Current ¹	0 ~ 180A
	Output Power	0 ~ 9KW
	Internal Sink Power ¹	0 ~ 450W
	External Sink Power ¹	0 ~ 27KW
Output Resistance	Range	0 ~ 4.444Ω
	Accuracy ²	0.25%+100mΩ
	Resolution	1mΩ
Line regulation ±(% of Output+Offset)	Voltage	≤0.01%+20mV
	Current	≤0.01%+90mA
Load regulation ±(% of Output+Offset)	Voltage	≤0.01%+50mV
	Current	≤0.05%+180mA
Setup Resolution	Voltage	10mV

Parameter		IT6543C Version: V1.4
	Current	10mA
	Power	0.1W
Read Back Resolution	Voltage	10mV
	Current	10mA
	Power	0.1W
Setup Accuracy (within 12 months, 25°C ±5°C) ±(%of Output+Offset)	Voltage	≤0.05%+100mV
	Current	≤0.2%+180mA
	Power	≤1%+90W
Read Back Accuracy (within 12 months, 25°C ±5°C) ±(%of Output+Offset)	Voltage	≤0.05%+100mV
	Current	≤0.2%+180mA
	Power	≤1%+90W
Ripple (20Hz -20MHz)	Voltage	≤200mVp-p
	Current	≤150mA _{rms}
Setup Temperature Coefficient (%of Output/°C+Offset)	Voltage	≤0.05 %+100mV
	Current	≤0.2%+180mA
Read Back Temperature Coefficient (%of Output/°C+Offset)	Voltage	≤0.05%+100mV
	Current	≤0.2%+180mA
Rise time(no load) ⁵	Voltage	≤15ms
Rise time(full load) ⁵	Voltage	≤30ms
Fall time(no load) ⁵	Voltage	≤50ms
Fall time(full load) ⁵	Voltage	≤15ms
Current seamless switching ⁶	-90% ~ 90%	≤30ms
	90% ~ -90%	≤30ms
Transient Response Time	Voltage	≤2ms
AC Input ⁷	Voltage	220V±10%
	Frequency	47Hz ~ 63Hz
Setup stability-30min (%of Output +Offset)	Voltage	≤0.05%+100mV
	Current	≤0.2%+180mA
Setup stability-8h (%of Output +Offset)	Voltage	≤0.05%+100mV
	Current	≤0.2%+180mA
Readback stability-30min (%of Output +Offset)	Voltage	≤0.05%+100mV
	Current	≤0.2%+180mA
Readback stability-8h	Voltage	≤0.05%+100mV

Parameter		IT6543C Version: V1.4
(%of Output +Offset)	Current	$\leq 0.2\% + 180\text{mA}$
Efficiency		89%(50V/180A) ~ 90.5%(200V/45A)
Remote Sense Compensation Voltage		2V
Command Response Time		20mS
Power Factor		0.99
Maximum input current ⁸		19A
Maximum input apparent power		11400VA
Storage temperature		-10°C ~ 70°C
Protective function		Source OVP, OCP, OPP and Load OCP, OPP, OTP, Vsense reversed
standard Interface		USB/RS232/CAN/GPIB/LAN
Isolation (output to ground)		500V
Series Number		≤ 2
Parallel Number		≤ 8
Parallel Number of Power Dissipater		3/6/9
Working temperature		0 ~ 40°C
Dimension (mm)		483mmW×283.2mmH×640.8mmD
Weight(net)		53Kg

5.1.14 IT6553C

Parameter		IT6553C Version: V1.4
Output Rating (0 °C-40 °C)	Output Voltage	0 ~ 200V
	Output Current	0 ~ 240A
	Internal Sink Current ¹	0 ~ 100A
	External Sink Current ¹	0 ~ 240A
	Output Power	0 ~ 12KW
	Internal Sink Power ¹	0 ~ 600W
	External Sink Power ¹	0 ~ 36KW

Parameter		IT6553C Version: V1.4
Output Resistance	Range	0 ~ 3.333Ω
	Accuracy ²	0.25%+100mΩ
	Resolution	1mΩ
Line regulation ±(% of Output+Offset)	Voltage	≤0.01%+20mV
	Current	≤0.01%+120mA
Load regulation ±(% of Output+Offset)	Voltage	≤0.01%+50mV
	Current	≤0.05%+240mA
Setup Resolution	Voltage	10mV
	Current	100mA
	Power	0.1W
Read Back Resolution	Voltage	10mV
	Current	100mA
	Power	0.1W
Setup Accuracy (within 12 months, 25°C ±5°C) ±(% of Output+Offset)	Voltage	≤0.05%+100mV
	Current	≤0.2%+240mA
	Power	≤1%+120W
Read Back Accuracy (within 12 months, 25°C ±5°C) ±(% of Output+Offset)	Voltage	≤0.05%+100mV
	Current	≤0.2%+240mA
	Power	≤1%+120W
Ripple (20Hz -20MHz)	Voltage	≤200mVp-p
	Current	≤200mArms
Setup Temperature Coefficient (% of Output/°C+Offset)	Voltage	≤0.05 %+100mV
	Current	≤0.2%+240mA
Read Back Temperature Coefficient (% of Output/°C+Offset)	Voltage	≤0.05%+100mV
	Current	≤0.2%+240mA
Rise time(no load) ⁵	Voltage	≤15ms
Rise time(full load) ⁵	Voltage	≤30ms
Fall time(no load) ⁵	Voltage	≤50ms
Fall time(full load) ⁵	Voltage	≤15ms
Current seamless switching ⁶	-90% ~ 90%	≤40ms
	90% ~ -90%	≤40ms
Transient Response Time	Voltage	≤2ms
AC Input ⁷	Voltage	380Vac±10%(Three-phase five wire)

Parameter		IT6553C Version: V1.4
	Frequency	47Hz ~ 63Hz
Setup stability-30min (%of Output +Offset)	Voltage	$\leq 0.05\% + 100\text{mV}$
	Current	$\leq 0.2\% + 240\text{mA}$
Setup stability-8h (%of Output +Offset)	Voltage	$\leq 0.05\% + 100\text{mV}$
	Current	$\leq 0.2\% + 240\text{mA}$
Readback stability-30min (%of Output +Offset)	Voltage	$\leq 0.05\% + 100\text{mV}$
	Current	$\leq 0.2\% + 240\text{mA}$
Readback stability-8h (%of Output +Offset)	Voltage	$\leq 0.05\% + 100\text{mV}$
	Current	$\leq 0.2\% + 240\text{mA}$
Efficiency	89%(50V/240A) ~ 90.5%(200V/60A)	
Remote Sense Compensation Voltage	2V	
Command Response Time	20mS	
Power Factor	0.99	
Maximum input current ⁸	38A	
Maximum input apparent power	15200VA	
Storage temperature	-10°C ~ 70°C	
Protective function	Source OVP, OCP, OPP and Load OCP, OPP, OTP, Vsense reversed	
standard Interface	USB/RS232/CAN/GPIB/LAN	
Isolation (output to ground)	500V	
Series Number	≤ 2	
Parallel Number	≤ 8	
Parallel Number of Power Dissipater	4/8/12	
Working temperature	0 ~ 40°C	
Dimension (mm)	554mmW×902mmH×807.5mmD (ITECH 15UCabinet)	
Weight(net)	119Kg	

5.1.15 IT6563C

Parameter		IT6563C Version: V1.4
Output Rating (0 °C-40 °C)	Output Voltage	0 ~ 200V

Parameter		IT6563C Version: V1.4
	Output Current	0 ~ 300A
	Internal Sink Current ¹	0 ~ 125A
	External Sink Current ¹	0 ~ 300A
	Output Power	0 ~ 15KW
	Internal Sink Power ¹	0 ~ 750W
	External Sink Power ¹	0 ~ 45KW
Output Resistance	Range	0 ~ 2.666Ω
	Accuracy ²	0.25%+100mΩ
	Resolution	1mΩ
Line regulation ±(% of Output+Offset)	Voltage	≤0.01%+20mV
	Current	≤0.01%+150mA
Load regulation ±(% of Output+Offset)	Voltage	≤0.01%+50mV
	Current	≤0.05%+300mA
Setup Resolution	Voltage	10mV
	Current	100mA
	Power	0.1W
Read Back Resolution	Voltage	10mV
	Current	100mA
	Power	0.1W
Setup Accuracy (within 12 months, 25°C ±5°C) ±(% of Output+Offset)	Voltage	≤0.05%+100mV
	Current	≤0.2%+300mA
	Power	≤1%+150W
Read Back Accuracy (within 12 months, 25°C ±5°C) ±(% of Output+Offset)	Voltage	≤0.05%+100mV
	Current	≤0.2%+300mA
	Power	≤1%+150W
Ripple (20Hz -20MHz)	Voltage	≤200mVp-p
	Current	≤250mArms
Setup Temperature Coefficient (% of Output/°C+Offset)	Voltage	≤0.05 %+100mV
	Current	≤0.2%+300mA
Read Back Temperature Coefficient (% of Output/°C+Offset)	Voltage	≤0.05%+100mV
	Current	≤0.2%+300mA

Parameter		IT6563C Version: V1.4
Rise time(no load) ⁵	Voltage	≤15ms
Rise time(full load) ⁵	Voltage	≤30ms
Fall time(no load) ⁵	Voltage	≤50ms
Fall time(full load) ⁵	Voltage	≤15ms
Current seamless switching ⁶	-90% ~ 90%	≤50ms
	90% ~ -90%	≤50ms
Transient Response Time	Voltage	≤2ms
AC Input ⁷	Voltage	380Vac±10%(Three-phase five wire)
	Frequency	47Hz ~ 63Hz
Setup stability-30min (%of Output +Offset)	Voltage	≤0.05%+100mV
	Current	≤0.2%+300mA
Setup stability-8h (%of Output +Offset)	Voltage	≤0.05%+100mV
	Current	≤0.2%+300mA
Readback stability-30min (%of Output +Offset)	Voltage	≤0.05%+100mV
	Current	≤0.2%+300mA
Readback stability-8h (%of Output +Offset)	Voltage	≤0.05%+100mV
	Current	≤0.2%+300mA
Efficiency	89%(50V/300A) ~ 90.5%(200V/75A)	
Remote Sense Compensation Voltage	2V	
Command Response Time	20mS	
Power Factor	0.99	
Maximum input current ⁸	38A	
Maximum input apparent power	19000VA	
Storage temperature	-10°C ~ 70°C	
Protective function	Source OVP, OCP, OPP and Load OCP, OPP, OTP, Vsense reversed	
standard Interface	USB/RS232/CAN/GPIB/LAN	
Isolation (output to ground)	500V	
Series Number	≤2	
Parallel Number	≤8	
Parallel Number of Power Dissipater	5/10/15	

Parameter		IT6563C Version: V1.4
Working temperature	0 ~ 40°C	
Dimension (mm)	554mmW×902mmH×807.5mmD (ITECH 15UCabinet)	
Weight(net)	137Kg	

5.1.16 IT6573C

Parameter		IT6573C Version: V1.4
Output Rating (0 °C-40 °C)	Output Voltage	0 ~ 200V
	Output Current	0 ~ 420A
	Internal Sink Current ¹	0 ~ 175A
	External Sink Current ¹	0 ~ 420A
	Output Power	0 ~ 21KW
	Internal Sink Power ¹	0 ~ 1050W
	External Sink Power ¹	0 ~ 63KW
Output Resistance	Range	0 ~ 1.904Ω
	Accuracy ²	0.25%+100mΩ
	Resolution	1mΩ
Line regulation ±(%of Output+Offset)	Voltage	≤0.01%+20mV
	Current	≤0.01%+210mA
Load regulation ±(%of Output+Offset)	Voltage	≤0.01%+50mV
	Current	≤0.05%+420mA
Setup Resolution	Voltage	10mV
	Current	100mA
	Power	0.1W
Read Back Resolution	Voltage	10mV
	Current	100mA
	Power	0.1W
Setup Accuracy (within 12 months, 25°C ±5°C) ±(%of Output+Offset)	Voltage	≤0.05%+100mV
	Current	≤0.2%+420mA
	Power	≤1%+210W
Read Back Accuracy	Voltage	≤0.05%+100mV

Parameter		IT6573C Version: V1.4
(within 12 months, 25°C ±5°C) ±(% of Output+Offset)	Current	≤0.2%+420mA
	Power	≤1%+210W
Ripple (20Hz -20MHz)	Voltage	≤200mVp-p
	Current	≤350mArms
Setup Temperature Coefficient (% of Output/°C+Offset)	Voltage	≤0.05 %+100mV
	Current	≤0.2%+420mA
Read Back Temperature Coefficient (% of Output/°C+Offset)	Voltage	≤0.05%+100mV
	Current	≤0.2%+420mA
Rise time(no load) ⁵	Voltage	≤15ms
Rise time(full load) ⁵	Voltage	≤30ms
Fall time(no load) ⁵	Voltage	≤50ms
Fall time(full load) ⁵	Voltage	≤15ms
Current seamless switching ⁶	-90% ~ 90%	≤70ms
	90% ~ -90%	≤70ms
Transient Response Time	Voltage	≤2ms
AC Input ⁷	Voltage	380V±10%(Three-phase five wire)
	Frequency	47Hz ~ 63Hz
Setup stability-30min (% of Output +Offset)	Voltage	≤0.05%+100mV
	Current	≤0.2%+420mA
Setup stability-8h (% of Output +Offset)	Voltage	≤0.05%+100mV
	Current	≤0.2%+420mA
Readback stability-30min (% of Output +Offset)	Voltage	≤0.05%+100mV
	Current	≤0.2%+420mA
Readback stability-8h (% of Output +Offset)	Voltage	≤0.05%+100mV
	Current	≤0.2%+420mA
Efficiency	89%(50V/420A) ~ 90.5%(200V/105A)	
Remote Sense Compensation Voltage	2V	
Command Response Time	20mS	
Power Factor	0.99	
Maximum input current ⁸	57A	

Parameter		IT6573C Version: V1.4
Maximum input apparent power		26600VA
Storage temperature		-10°C ~ 70°C
Protective function		Source OVP, OCP, OPP and Load OCP, OPP, OTP, Vsense reversed
standard Interface		USB/RS232/CAN/GPIB/LAN
Isolation (output to ground)		500V
Series Number		≤2
Parallel Number		≤8
Parallel Number of Power Dissipater		7/14/21
Working temperature		0 ~ 40°C
Dimension (mm)		550mmW×1289.3mmH×834.8mmD(ITECH 24UCabinet)
Weight(net)		230Kg

5.1.17 IT6583C

Parameter		IT6583C Version: V1.4
Output Rating (0 °C-40 °C)	Output Voltage	0 ~ 200V
	Output Current	0 ~ 480A
	Internal Sink Current ¹	0 ~ 200A
	External Sink Current ¹	0 ~ 480A
	Output Power	0 ~ 24KW
	Internal Sink Power ¹	0 ~ 1200W
	External Sink Power ¹	0 ~ 72KW
Output Resistance	Range	0 ~ 1.666Ω
	Accuracy ²	0.25%+100mΩ
	Resolution	1mΩ
Line regulation ±(%of Output+Offset)	Voltage	≤0.01%+20mV
	Current	≤0.01%+240mA
Load regulation ±(%of Output+Offset)	Voltage	≤0.01%+50mV
	Current	≤0.05%+480mA
Setup Resolution	Voltage	10mV

Parameter		IT6583C Version: V1.4
	Current	100mA
	Power	0.1W
Read Back Resolution	Voltage	10mV
	Current	100mA
	Power	0.1W
	Voltage	$\leq 0.05\% + 100\text{mV}$
Setup Accuracy (within 12 months, 25°C ±5°C) ±(% of Output+Offset)	Current	$\leq 0.2\% + 480\text{mA}$
	Power	$\leq 1\% + 240\text{W}$
	Voltage	$\leq 0.05\% + 100\text{mV}$
Read Back Accuracy (within 12 months, 25°C ±5°C) ±(% of Output+Offset)	Current	$\leq 0.2\% + 480\text{mA}$
	Power	$\leq 1\% + 240\text{W}$
	Voltage	$\leq 0.05\% + 100\text{mV}$
Ripple (20Hz -20MHz)	Voltage	$\leq 200\text{mVp-p}$
	Current	$\leq 400\text{mA}_{\text{rms}}$
Setup Temperature Coefficient (% of Output/°C+Offset)	Voltage	$\leq 0.05\% + 100\text{mV}$
	Current	$\leq 0.2\% + 480\text{mA}$
Read Back Temperature Coefficient (% of Output/°C+Offset)	Voltage	$\leq 0.05\% + 100\text{mV}$
	Current	$\leq 0.2\% + 480\text{mA}$
Rise time(no load) ⁵	Voltage	$\leq 15\text{ms}$
Rise time(full load) ⁵	Voltage	$\leq 30\text{ms}$
Fall time(no load) ⁵	Voltage	$\leq 50\text{ms}$
Fall time(full load) ⁵	Voltage	$\leq 15\text{ms}$
Current seamless switching ⁶	-90% ~ 90%	$\leq 80\text{ms}$
	90% ~ -90%	$\leq 80\text{ms}$
Transient Response Time	Voltage	$\leq 2\text{ms}$
AC Input ⁷	Voltage	380V±10%(Three-phase five wire)
	Frequency	47Hz ~ 63Hz
Setup stability-30min (% of Output +Offset)	Voltage	$\leq 0.05\% + 100\text{mV}$
	Current	$\leq 0.2\% + 480\text{mA}$
Setup stability-8h (% of Output +Offset)	Voltage	$\leq 0.05\% + 100\text{mV}$
	Current	$\leq 0.2\% + 480\text{mA}$
Readback stability-30min (% of Output +Offset)	Voltage	$\leq 0.05\% + 100\text{mV}$
	Current	$\leq 0.2\% + 480\text{mA}$
Readback stability-8h	Voltage	$\leq 0.05\% + 100\text{mV}$

Parameter		IT6583C Version: V1.4
(%of Output +Offset)	Current	≤0.2%+480mA
Efficiency	89%(50V/480A) ~ 90.5%(200V/120A)	
Remote Sense Compensation Voltage	2V	
Command Response Time	20mS	
Power Factor	0.99	
Maximum input current ⁸	57A	
Maximum input apparent power	30400VA	
Storage temperature	-10°C ~ 70°C	
Protective function	Source OVP, OCP, OPP and Load OCP, OPP, OTP,Vsense reversed	
standard Interface	USB/RS232/CAN/GPIB/LAN	
Isolation (output to ground)	500V	
Series Number	≤2	
Parallel Number	≤8	
Parallel Number of Power Dissipater	8/16/24	
Working temperature	0 ~ 40°C	
Dimension (mm)	550mmW×1289.3mmH×834.8mmD	
Weight(net)	248Kg	

5.1.18 IT6593C

Parameter		IT6593C Version: V1.4
Output Rating (0 °C-40 °C)	Output Voltage	0 ~ 200V
	Output Current	0 ~ 600A
	Internal Sink Current ¹	0 ~ 250A
	External Sink Current ¹	0 ~ 600A
	Output Power	0 ~ 30KW
	Internal Sink Power ¹	0 ~ 1500W
	External Sink Power ¹	0 ~ 90KW

Parameter		IT6593C Version: V1.4
Output Resistance	Range	0 ~ 1.333Ω
	Accuracy ²	0.25%+100mΩ
	Resolution	1mΩ
Line regulation ±(% of Output+Offset)	Voltage	≤0.01%+20mV
	Current	≤0.01%+300mA
Load regulation ±(% of Output+Offset)	Voltage	≤0.01%+50mV
	Current	≤0.05%+600mA
Setup Resolution	Voltage	10mV
	Current	100mA
	Power	0.1W
Read Back Resolution	Voltage	10mV
	Current	100mA
	Power	0.1W
Setup Accuracy (within 12 months, 25°C±5°C) ±(% of Output+Offset)	Voltage	≤0.05%+100mV
	Current	≤0.2%+600mA
	Power	≤1%+300W
Read Back Accuracy (within 12 months, 25°C±5°C) ±(% of Output+Offset)	Voltage	≤0.05%+100mV
	Current	≤0.2%+600mA
	Power	≤1%+300W
Ripple (20Hz -20MHz)	Voltage	≤200mVp-p
	Current	≤500mArms
Setup Temperature Coefficient (% of Output/°C+Offset)	Voltage	≤0.05 %+100mV
	Current	≤0.2%+600mA
Read Back Temperature Coefficient (% of Output/°C+Offset)	Voltage	≤0.05%+100mV
	Current	≤0.2%+600mA
Rise time(no load) ⁵	Voltage	≤15ms
Rise time(full load) ⁵	Voltage	≤30ms
Fall time(no load) ⁵	Voltage	≤50ms
Fall time(full load) ⁵	Voltage	≤15ms
Current seamless switching ⁶	-90% ~ 90%	≤100ms
	90% ~ -90%	≤100ms
Transient Response Time	Voltage	≤2ms

Parameter		IT6593C Version: V1.4
AC Input ⁷	Voltage	380V±10%(Three-phase five wire)
	Frequency	47Hz ~ 63Hz
Setup stability-30min (%of Output +Offset)	Voltage	≤0.05%+100mV
	Current	≤0.2%+600mA
Setup stability-8h (%of Output +Offset)	Voltage	≤0.05%+100mV
	Current	≤0.2%+600mA
Readback stability-30min (%of Output +Offset)	Voltage	≤0.05%+100mV
	Current	≤0.2%+600mA
Readback stability-8h (%of Output +Offset)	Voltage	≤0.05%+100mV
	Current	≤0.2%+600mA
Efficiency	89%(50V/600A) ~ 90.5%(200V/150A)	
Remote Sense Compensation Voltage	2V	
Command Response Time	20mS	
Power Factor	0.99	
Maximum input current ⁸	76A	
Maximum input apparent power	38000VA	
Storage temperature	-10°C ~ 70°C	
Protective function	Source OVP, OCP, OPP and Load OCP, OPP, OTP, Vsense reversed	
standard Interface	USB/RS232/CAN/GPIB/LAN	
Isolation (output to ground)	500V	
Series Number	≤2	
Parallel Number	≤8	
Parallel Number of Power Dissipater	10/20/30	
Working temperature	0 ~ 40°C	
Dimension (mm)	550mmW×1289.3mmH×834.8mmD	
Weight(net)	284Kg	

5.1.19 IT6514C

Parameter		IT6514C Version: V1.4
Output Rating (0 °C-40 °C)	Output Voltage	0 ~ 360V
	Output Current	0 ~ 30A
	Internal Sink Current1	0 ~ 12.5A
	External Sink Current1	0 ~ 30A
	Output Power	0 ~ 1800W
	Internal Sink Power1	0 ~ 150W
	External Sink Power1	0 ~ 5.4KW
Output Resistance	Range	0 ~ 72Ω
	Accuracy2	0.25%+135mΩ*A
	Resolution	1mΩ
Line regulation ±(% of Output+Offset)	Voltage	≤0.01%+40mV
	Current	≤0.01%+15mA
Load regulation ±(% of Output+Offset)	Voltage	≤0.01%+135mV
	Current	≤0.05%+30mA
Setup Resolution	Voltage	10mV
	Current	10mA
	Power	0.1W
Read Back Resolution	Voltage	10mV
	Current	10mA
	Power	0.1W
Setup Accuracy ³ (within 12 months, 25°C±5°C) ±(% of Output+Offset)	Voltage	≤0.05%+135mV
	Current	≤0.2%+30mA
	Power	1%+30W
Read Back Accuracy ⁴ (within 12 months, 25°C±5°C) ±(% of Output+Offset)	Voltage	≤0.05%+135mV
	Current	≤0.2%+30mA
	Power	1%+30W
Ripple (20Hz -20MHz)	Voltage	≤360mVp-p
	Current	≤0.05%+30mArms
Setup Temperature Coefficient	Voltage	≤0.01%+135mV

Parameter		IT6514C Version: V1.4
(% of Output/°C+Offset)	Current	$\leq 0.02\% + 30\text{mA}$
Read Back Temperature Coefficient (% of Output/°C+Offset)	Voltage	$\leq 0.01\% + 135\text{mV}$
	Current	$\leq 0.02\% + 30\text{mA}$
Rise time(no load) ⁵	Voltage	$\leq 50\text{ms}$
Rise time(full load) ⁵	Voltage	$\leq 80\text{ms}$
Fall time(no load) ⁵	Voltage	$\leq 250\text{ms}$
Fall time(full load) ⁵	Voltage	$\leq 110\text{ms}$
Current seamless switching ⁶	-90% ~ 90%	$\leq 50\text{ms}$
	90% ~ -90%	$\leq 50\text{ms}$
Transient Response Time	Voltage	$\leq 3\text{ms}$
AC Input ⁷	Voltage	$220\text{V} \pm 10\%$
	Frequency	47Hz ~ 63Hz
Setup stability-30min (% of Output +Offset)	Voltage	$\leq 0.05\% + 135\text{mV}$
	Current	$\leq 0.1\% + 30\text{mA}$
Setup stability-8h (% of Output +Offset)	Voltage	$\leq 0.05\% + 135\text{mV}$
	Current	$\leq 0.1\% + 30\text{mA}$
Readback stability-30min (% of Output +Offset)	Voltage	$\leq 0.05\% + 135\text{mV}$
	Current	$\leq 0.1\% + 30\text{mA}$
Readback stability-8h (% of Output +Offset)	Voltage	$\leq 0.05\% + 135\text{mV}$
	Current	$\leq 0.1\% + 30\text{mA}$
Efficiency	80%	
Remote Sense Compensation Voltage	3V	
Command Response Time	20mS	
Power Factor	0.99	
Maximum input current ⁸	12A	
Maximum input apparent power	2300VA	
Storage temperature	$-10^{\circ}\text{C} \sim 70^{\circ}\text{C}$	
Protective function	Source OVP, OCP, OPP and Load OCP, OPP, OTP, Vsense reversed	
standard Interface	USB/RS232/CAN/GPIB/LAN	

Parameter		IT6514C Version: V1.4
Isolation (output to ground)		500V
Parallel Number		≤8
Parallel Number of Power Dissipater		1/2/3
Working temperature		0 ~ 40°C
Dimension (mm)		483mmW×105.4mmH×640.8mmD
Weight(net)		17Kg

5.1.20 IT6524C

Parameter		IT6524C Version: V1.4
Output Rating (0 °C-40 °C)	Output Voltage	0 ~ 360V
	Output Current	0 ~ 30A
	Internal Sink Current ¹	0 ~ 12.5A
	External Sink Current ¹	0 ~ 30A
	Output Power	0 ~ 3000W
	Internal Sink Power ¹	0 ~ 150W
	External Sink Power ¹	0 ~ 9KW
Output Resistance	Range	0 ~ 43.2Ω
	Accuracy ²	0.25%+135mΩ*A
	Resolution	1mΩ
Line regulation ±(% of Output+Offset)	Voltage	≤0.01%+40mV
	Current	≤0.01%+15mA
Load regulation ±(% of Output+Offset)	Voltage	≤0.01%+135mV
	Current	≤0.05%+30mA
Setup Resolution	Voltage	10mV
	Current	10mA
	Power	0.1W
Read Back Resolution	Voltage	10mV
	Current	10mA
	Power	0.1W
Setup Accuracy ³	Voltage	≤0.05%+135mV

Parameter		IT6524C Version: V1.4
(within 12 months, 25°C±5°C) ±(% of Output+Offset)	Current	≤0.2%+30mA
	Power	1%+30W
Read Back Accuracy ⁴ (within 12 months, 25°C±5°C) ±(% of Output+Offset)	Voltage	≤0.05%+135mV
	Current	≤0.2%+30mA
	Power	1%+30W
Ripple (20Hz -20MHz)	Voltage	≤360mVp-p
	Current	≤0.05%+30mArms
Setup Temperature Coefficient (% of Output/°C+Offset)	Voltage	≤0.01%+135mV
	Current	≤0.02%+30mA
Read Back Temperature Coefficient (% of Output/°C+Offset)	Voltage	≤0.01%+135mV
	Current	≤0.02%+30mA
Rise time(no load) ⁵	Voltage	≤50ms
Rise time(full load) ⁵	Voltage	≤80ms
Fall time(no load) ⁵	Voltage	≤250ms
Fall time(full load) ⁵	Voltage	≤55ms
Current seamless switching ⁶	-90% ~ 90%	≤50ms
	90% ~ -90%	≤50ms
Transient Response Time	Voltage	≤3ms
AC Input ⁷	Voltage	220V±10%
	Frequency	47Hz ~ 63Hz
Setup stability-30min (% of Output +Offset)	Voltage	≤0.05%+135mV
	Current	≤0.1%+30mA
Setup stability-8h (% of Output +Offset)	Voltage	≤0.05%+135mV
	Current	≤0.1%+30mA
Readback stability- 30min (% of Output +Offset)	Voltage	≤0.05%+135mV
	Current	≤0.1%+30mA
Readback stability-8h (% of Output +Offset)	Voltage	≤0.05%+135mV
	Current	≤0.1%+30mA
Efficiency	80%	
Remote Sense Compensation Voltage	3V	

Parameter		IT6524C Version: V1.4
Command Response Time		20mS
Power Factor		0.99
Maximum input current ⁸		19A
Maximum input apparent power		3800VA
Storage temperature		-10°C ~ 70°C
Protective function		Source OVP, OCP, OPP and Load OCP, OPP, OTP, Vsense reversed
standard Interface		USB/RS232/CAN/GPIB/LAN
Isolation (output to ground)		500V
Parallel Number		≤8
Parallel Number of Power Dissipater		1/2/3
Working temperature		0 ~ 40°C
Dimension (mm)		483mmW×105.4mmH×640.8mmD
Weight(net)		17Kg

5.1.21 IT6534C

Parameter		IT6534C Version: V1.4
Output Rating (0 °C-40 °C)	Output Voltage	0 ~ 360V
	Output Current	0 ~ 60A
	Internal Sink Current ¹	0 ~ 25A
	External Sink Current ¹	0 ~ 60A
	Output Power	0 ~ 6KW
	Internal Sink Power ¹	0 ~ 300W
	External Sink Power ¹	0 ~ 18KW
Output Resistance	Range	0 ~ 21.6Ω
	Accuracy ²	0.25%+135mΩ*A
	Resolution	1mΩ

Parameter		IT6534C Version: V1.4
Line regulation ±(% of Output+Offset)	Voltage	≤0.01%+40mV
	Current	≤0.01%+30mA
Load regulation ±(% of Output+Offset)	Voltage	≤0.01%+135mV
	Current	≤0.05%+60mA
Setup Resolution	Voltage	10mV
	Current	10mA
	Power	0.1W
Read Back Resolution	Voltage	10mV
	Current	10mA
	Power	0.1W
Setup Accuracy ³ (within 12 months, 25°C±5°C) ±(% of Output+Offset)	Voltage	≤0.05%+135mV
	Current	≤0.2%+60mA
	Power	1%+60W
Read Back Accuracy ⁴ (within 12 months, 25°C±5°C) ±(% of Output+Offset)	Voltage	≤0.05%+135mV
	Current	≤0.2%+60mA
	Power	1%+60W
Ripple (20Hz -20MHz)	Voltage	≤360mVp-p
	Current	≤0.05%+60mArms
Setup Temperature Coefficient (% of Output/°C+Offset)	Voltage	≤0.01%+135mV
	Current	≤0.02%+60mA
Read Back Temperature Coefficient (% of Output/°C+Offset)	Voltage	≤0.01%+135mV
	Current	≤0.02%+60mA
Rise time(no load) ⁵	Voltage	≤50ms
Rise time(full load) ⁵	Voltage	≤80ms
Fall time(no load) ⁵	Voltage	≤250ms
Fall time(full load) ⁵	Voltage	≤55ms
Current seamless switching ⁶	-90% ~ 90%	≤100ms
	90% ~ -90%	≤100ms
Transient Response Time	Voltage	≤3ms
AC Input ⁷	Voltage	220V±10%
	Frequency	47Hz ~ 63Hz
Setup stability-30min (% of Output +Offset)	Voltage	≤0.05%+135mV

Parameter		IT6534C Version: V1.4
	Current	$\leq 0.1\% + 60\text{mA}$
Setup stability-8h (%of Output +Offset)	Voltage	$\leq 0.05\% + 135\text{mV}$
	Current	$\leq 0.1\% + 60\text{mA}$
Readback stability-30min (%of Output +Offset)	Voltage	$\leq 0.05\% + 135\text{mV}$
	Current	$\leq 0.1\% + 60\text{mA}$
Readback stability-8h (%of Output +Offset)	Voltage	$\leq 0.05\% + 135\text{mV}$
	Current	$\leq 0.1\% + 60\text{mA}$
Efficiency	80%	
Remote Sense Compensation Voltage	3V	
Command Response Time	20mS	
Power Factor	0.99	
Maximum input current ⁸	38A	
Maximum input apparent power	7600VA	
Storage temperature	$-10^{\circ}\text{C} \sim 70^{\circ}\text{C}$	
Protective function	Source OVP, OCP, OPP and Load OCP, OPP, OTP, Vsense reversed	
standard Interface	USB/RS232/CAN/GPIB/LAN	
Isolation (output to ground)	500V	
Parallel Number	≤ 8	
Parallel Number of Power Dissipater	2/4/6	
Working temperature	$0 \sim 40^{\circ}\text{C}$	
Dimension (mm)	483mmW×194mmH×640.8mmD	
Weight(net)	35Kg	

5.1.22 IT6544C

Parameter		IT6544C Version: V1.4
Output Rating (0 °C-40 °C)	Output Voltage	0 ~ 360V
	Output Current	0 ~ 90A

Parameter		IT6544C Version: V1.4
	Internal Sink Current ¹	0 ~ 37.5A
	External Sink Current ¹	0 ~ 90A
	Output Power	0 ~ 9KW
	Internal Sink Power ¹	0 ~ 450W
	External Sink Power ¹	0 ~ 27KW
Output Resistance	Range	0 ~ 14.4Ω
	Accuracy ²	0.25%+135mΩ*A
	Resolution	1mΩ
Line regulation ±(% of Output+Offset)	Voltage	≤0.01%+40mV
	Current	≤0.01%+45mA
Load regulation ±(% of Output+Offset)	Voltage	≤0.01%+135mV
	Current	≤0.05%+90mA
Setup Resolution	Voltage	10mV
	Current	10mA
	Power	0.1W
Read Back Resolution	Voltage	10mV
	Current	10mA
	Power	0.1W
Setup Accuracy ³ (within 12 months, 25°C ±5°C) ±(% of Output+Offset)	Voltage	≤0.05%+135mV
	Current	≤0.2%+90mA
	Power	1%+90W
Read Back Accuracy ⁴ (within 12 months, 25°C ±5°C) ±(% of Output+Offset)	Voltage	≤0.05%+135mV
	Current	≤0.2%+90mA
	Power	1%+90W
Ripple (20Hz -20MHz)	Voltage	≤360mVp-p
	Current	≤0.05%+90mArms
Setup Temperature Coefficient (% of Output/°C+Offset)	Voltage	≤0.01%+135mV
	Current	≤0.02%+90mA
Read Back Temperature Coefficient (% of Output/°C+Offset)	Voltage	≤0.01%+135mV
	Current	≤0.02%+90mA
Rise time(no load) ⁵	Voltage	≤50ms

Parameter		IT6544C Version: V1.4
Rise time(full load) ⁵	Voltage	≤80ms
Fall time(no load) ⁵	Voltage	≤250ms
Fall time(full load) ⁵	Voltage	≤55ms
Current seamless switching ⁶	-90% ~ 90%	≤150ms
	90% ~ -90%	≤150ms
Transient Response Time	Voltage	≤3ms
AC Input ⁷	Voltage	220V±10%
	Frequency	47Hz ~ 63Hz
Setup stability-30min (%of Output +Offset)	Voltage	≤0.05%+135mV
	Current	≤0.1%+90mA
Setup stability-8h (%of Output +Offset)	Voltage	≤0.05%+135mV
	Current	≤0.1%+90mA
Readback stability-30min (%of Output +Offset)	Voltage	≤0.05%+135mV
	Current	≤0.1%+90mA
Readback stability-8h (%of Output +Offset)	Voltage	≤0.05%+135mV
	Current	≤0.1%+90mA
Efficiency	80%	
Remote Sense Compensation Voltage	3V	
Command Response Time	20mS	
Power Factor	0.99	
Maximum input current ⁸	19A	
Maximum input apparent power	11400VA	
Storage temperature	-10°C ~ 70°C	
Protective function	Source OVP, OCP, OPP and Load OCP, OPP, OTP, Vsense reversed	
standard Interface	USB/RS232/CAN/GPIB/LAN	
Isolation (output to ground)	500V	
Parallel Number	≤8	
Parallel Number of Power Dissipater	3/6/9	

Parameter	IT6544C Version: V1.4
Working temperature	0 ~ 40°C
Dimension (mm)	483mmW×283.2mmH×640.8mmD
Weight(net)	53Kg

5.1.23 IT6554C

Parameter	IT6554C Version: V1.4	
Output Rating (0 °C-40 °C)	Output Voltage	0 ~ 360V
	Output Current	0 ~ 120A
	Internal Sink Current ¹	0 ~ 50A
	External Sink Current ¹	0 ~ 120A
	Output Power	0 ~ 12KW
	Internal Sink Power ¹	0 ~ 600W
	External Sink Power ¹	0 ~ 36KW
Output Resistance	Range	0 ~ 10.8Ω
	Accuracy ²	0.25%+135mΩ*A
	Resolution	1mΩ
Line regulation ±(% of Output+Offset)	Voltage	≤0.01%+40mV
	Current	≤0.01%+60mA
Load regulation ±(% of Output+Offset)	Voltage	≤0.01%+135mV
	Current	≤0.05%+120mA
Setup Resolution	Voltage	10mV
	Current	10mA
	Power	0.1W
Read Back Resolution	Voltage	10mV
	Current	10mA
	Power	0.1W
Setup Accuracy ³ (within 12 months, 25°C ±5°C) ±(% of Output+Offset)	Voltage	≤0.05%+135mV
	Current	≤0.2%+120mA
	Power	1%+120W
Read Back Accuracy ⁴ (within 12 months, 25°C ±5°C)	Voltage	≤0.05%+135mV
	Current	≤0.2%+120mA

Parameter		IT6554C Version: V1.4
±(% of Output+Offset)	Power	1%+120W
Ripple (20Hz -20MHz)	Voltage	≤360mVp-p
	Current	≤0.05%+120mArms
Setup Temperature Coefficient (% of Output/°C+Offset)	Voltage	≤0.01%+135mV
	Current	≤0.02%+120mA
Read Back Temperature Coefficient (% of Output/°C+Offset)	Voltage	≤0.01%+135mV
	Current	≤0.02%+120mA
Rise time(no load) ⁵	Voltage	≤50ms
Rise time(full load) ⁵	Voltage	≤80ms
Fall time(no load) ⁵	Voltage	≤250ms
Fall time(full load) ⁵	Voltage	≤55ms
Current seamless switching ⁶	-90% ~ 90%	≤200ms
	90% ~ -90%	≤200ms
Transient Response Time	Voltage	≤3ms
AC Input ⁷	Voltage	380Vac±10%(Three-phase five wire)
	Frequency	47Hz ~ 63Hz
Setup stability-30min (% of Output +Offset)	Voltage	≤0.05%+135mV
	Current	≤0.1%+120mA
Setup stability-8h (% of Output +Offset)	Voltage	≤0.05%+135mV
	Current	≤0.1%+120mA
Readback stability-30min (% of Output +Offset)	Voltage	≤0.05%+135mV
	Current	≤0.1%+120mA
Readback stability-8h (% of Output +Offset)	Voltage	≤0.05%+135mV
	Current	≤0.1%+120mA
Efficiency	80%	
Remote Sense Compensation Voltage	3V	
Command Response Time	20mS	
Power Factor	0.99	
Maximum input current ⁸	38A	
Maximum input apparent power	15200VA	

Parameter	IT6554C Version: V1.4
Storage temperature	-10°C ~ 70°C
Protective function	Source OVP, OCP, OPP and Load OCP, OPP, OTP, Vsense reversed
standard Interface	USB/RS232/CAN/GPIB/LAN
Isolation (output to ground)	500V
Parallel Number	≤8
Parallel Number of Power Dissipater	4/8/12
Working temperature	0 ~ 40°C
Dimension (mm)	554mmW×902mmH×807.5mmD (ITECH 15UCabinet)
Weight(net)	119Kg

5.1.24 IT6564C

Parameter	IT6564C Version: V1.4	
Output Rating (0 °C-40 °C)	Output Voltage	0 ~ 360V
	Output Current	0 ~ 150A
	Internal Sink Current ¹	0 ~ 62.5A
	External Sink Current ¹	0 ~ 150A
	Output Power	0 ~ 15KW
	Internal Sink Power ¹	0 ~ 750W
	External Sink Power ¹	0 ~ 45KW
Output Resistance	Range	0 ~ 8.64Ω
	Accuracy ²	0.25%+135mΩ*A
	Resolution	1mΩ
Line regulation ±(% of Output+Offset)	Voltage	≤0.01%+40mV
	Current	≤0.01%+75mA
Load regulation ±(% of Output+Offset)	Voltage	≤0.01%+135mV
	Current	≤0.05%+150mA
Setup Resolution	Voltage	10mV

Parameter		IT6564C Version: V1.4
	Current	10mA
	Power	0.1W
Read Back Resolution	Voltage	10mV
	Current	10mA
	Power	0.1W
Setup Accuracy ³ (within 12 months, 25°C ±5°C) ±(% of Output+Offset)	Voltage	≤0.05%+135mV
	Current	≤0.2%+150mA
	Power	1%+150W
Read Back Accuracy ⁴ (within 12 months, 25°C ±5°C) ±(% of Output+Offset)	Voltage	≤0.05%+135mV
	Current	≤0.2%+150mA
	Power	1%+150W
Ripple (20Hz -20MHz)	Voltage	≤360mVp-p
	Current	≤0.05%+150mArms
Setup Temperature Coefficient (% of Output/°C+Offset)	Voltage	≤0.01%+135mV
	Current	≤0.02%+150mA
Read Back Temperature Coefficient (% of Output/°C+Offset)	Voltage	≤0.01%+135mV
	Current	≤0.02%+150mA
Rise time(no load) ⁵	Voltage	≤50ms
Rise time(full load) ⁵	Voltage	≤80ms
Fall time(no load) ⁵	Voltage	≤250ms
Fall time(full load) ⁵	Voltage	≤55ms
Current seamless switching ⁶	-90% ~ 90%	≤250ms
	90% ~ -90%	≤250ms
Transient Response Time	Voltage	≤3ms
AC Input ⁷	Voltage	380Vac±10%(Three-phase five wire)
	Frequency	47Hz ~ 63Hz
Setup stability-30min (% of Output +Offset)	Voltage	≤0.05%+135mV
	Current	≤0.1%+150mA
Setup stability-8h (% of Output +Offset)	Voltage	≤0.05%+135mV
	Current	≤0.1%+150mA
Readback stability-30min (% of Output +Offset)	Voltage	≤0.05%+135mV
	Current	≤0.1%+150mA
Readback stability-8h	Voltage	≤0.05%+135mV

Parameter		IT6564C Version: V1.4
(%of Output +Offset)	Current	$\leq 0.1\% + 150\text{mA}$
Efficiency		80%
Remote Sense Compensation Voltage		3V
Command Response Time		20mS
Power Factor		0.99
Maximum input current ⁸		38A
Maximum input apparent power		19000VA
Storage temperature		-10°C ~ 70°C
Protective function		Source OVP, OCP, OPP and Load OCP, OPP, OTP, Vsense reversed
standard Interface		USB/RS232/CAN/GPIB/LAN
Isolation (output to ground)		500V
Parallel Number		≤ 8
Parallel Number of Power Dissipater		5/10/15
Working temperature		0 ~ 40°C
Dimension (mm)		554mmW×902mmH×807.5mmD (ITECH 15UCabinet)
Weight(net)		137Kg

5.1.25 IT6574C

Parameter		IT6574C Version: V1.4
Output Rating (0 °C-40 °C)	Output Voltage	0 ~ 360V
	Output Current	0 ~ 210A
	Internal Sink Current ¹	0 ~ 87.5A
	External Sink Current ¹	0 ~ 210A
	Output Power	0 ~ 21KW
	Internal Sink Power ¹	0 ~ 1050W
	External Sink Power ¹	0 ~ 63KW

Parameter		IT6574C Version: V1.4
Output Resistance	Range	0 ~ 6.171Ω
	Accuracy ²	0.25%+135mΩ*A
	Resolution	1mΩ
Line regulation ±(% of Output+Offset)	Voltage	≤0.01%+40mV
	Current	≤0.01%+105mA
Load regulation ±(% of Output+Offset)	Voltage	≤0.01%+135mV
	Current	≤0.05%+210mA
Setup Resolution	Voltage	10mV
	Current	100mA
	Power	0.1W
Read Back Resolution	Voltage	10mV
	Current	100mA
	Power	0.1W
Setup Accuracy ³ (within 12 months, 25°C±5°C) ±(% of Output+Offset)	Voltage	≤0.05%+135mV
	Current	≤0.2%+210mA
	Power	1%+210W
Read Back Accuracy ⁴ (within 12 months, 25°C±5°C) ±(% of Output+Offset)	Voltage	≤0.05%+135mV
	Current	≤0.2%+210mA
	Power	1%+210W
Ripple (20Hz -20MHz)	Voltage	≤360mVp-p
	Current	≤0.05%+210mArms
Setup Temperature Coefficient (% of Output/°C+Offset)	Voltage	≤0.01%+135mV
	Current	≤0.02%+210mA
Read Back Temperature Coefficient (% of Output/°C+Offset)	Voltage	≤0.01%+135mV
	Current	≤0.02%+210mA
Rise time(no load) ⁵	Voltage	≤50ms
Rise time(full load) ⁵	Voltage	≤80ms
Fall time(no load) ⁵	Voltage	≤250ms
Fall time(full load) ⁵	Voltage	≤55ms
Current seamless switching ⁶	-90% ~ 90%	≤350ms
	90% ~ -90%	≤350ms
Transient Response Time	Voltage	≤3ms

Parameter		IT6574C Version: V1.4
AC Input ⁷	Voltage	380V±10%(Three-phase five wire)
	Frequency	47Hz ~ 63Hz
Setup stability-30min (%of Output +Offset)	Voltage	≤0.05%+135mV
	Current	≤0.1%+210mA
Setup stability-8h (%of Output +Offset)	Voltage	≤0.05%+135mV
	Current	≤0.1%+210mA
Readback stability-30min (%of Output +Offset)	Voltage	≤0.05%+135mV
	Current	≤0.1%+210mA
Readback stability-8h (%of Output +Offset)	Voltage	≤0.05%+135mV
	Current	≤0.1%+210mA
Efficiency		80%
Remote Sense Compensation Voltage		3V
Command Response Time		20mS
Power Factor		0.99
Maximum input current ⁸		57A
Maximum input apparent power		26600VA
Storage temperature		-10°C ~ 70°C
Protective function		Source OVP, OCP, OPP and Load OCP, OPP, OTP, Vsense reversed
standard Interface		USB/RS232/CAN/GPIB/LAN
Isolation (output to ground)		500V
Parallel Number		≤8
Parallel Number of Power Dissipater		7/14/21
Working temperature		0 ~ 40°C
Dimension (mm)		550mmW×1289.3mmH×834.8mmD(ITECH 24UCabinet)
Weight(net)		230Kg

5.1.26 IT6584C

Parameter		IT6584C Version: V1.4
Output Rating (0 °C-40 °C)	Output Voltage	0 ~ 360V
	Output Current	0 ~ 240A
	Internal Sink Current ¹	0 ~ 100A
	External Sink Current ¹	0 ~ 240A
	Output Power	0 ~ 24KW
	Internal Sink Power ¹	0 ~ 1200W
	External Sink Power ¹	0 ~ 72KW
Output Resistance	Range	0 ~ 5.4Ω
	Accuracy ²	0.25%+135mΩ*A
	Resolution	1mΩ
Line regulation ±(% of Output+Offset)	Voltage	≤0.01%+40mV
	Current	≤0.01%+120mA
Load regulation ±(% of Output+Offset)	Voltage	≤0.01%+135mV
	Current	≤0.05%+240mA
Setup Resolution	Voltage	10mV
	Current	100mA
	Power	0.1W
Read Back Resolution	Voltage	10mV
	Current	100mA
	Power	0.1W
Setup Accuracy ³ (within 12 months, 25°C±5°C) ±(% of Output+Offset)	Voltage	≤0.05%+135mV
	Current	≤0.2%+240mA
	Power	1%+240W
Read Back Accuracy ⁴ (within 12 months, 25°C±5°C) ±(% of Output+Offset)	Voltage	≤0.05%+135mV
	Current	≤0.2%+240mA
	Power	1%+240W
Ripple (20Hz -20MHz)	Voltage	≤360mVp-p
	Current	≤0.05%+240mArms
Setup Temperature Coefficient (% of Output/°C+Offset)	Voltage	≤0.01%+135mV
	Current	≤0.02%+240mA

Parameter		IT6584C Version: V1.4
Read Back Temperature Coefficient (% of Output/°C+Offset)	Voltage	$\leq 0.01\% + 135\text{mV}$
	Current	$\leq 0.02\% + 240\text{mA}$
Rise time(no load) ⁵	Voltage	$\leq 50\text{ms}$
Rise time(full load) ⁵	Voltage	$\leq 80\text{ms}$
Fall time(no load) ⁵	Voltage	$\leq 250\text{ms}$
Fall time(full load) ⁵	Voltage	$\leq 55\text{ms}$
Current seamless switching ⁶	-90% ~ 90%	$\leq 400\text{ms}$
	90% ~ -90%	$\leq 400\text{ms}$
Transient Response Time	Voltage	$\leq 3\text{ms}$
AC Input ⁷	Voltage	$380\text{V} \pm 10\%$ (Three-phase five wire)
	Frequency	47Hz ~ 63Hz
Setup stability-30min (% of Output +Offset)	Voltage	$\leq 0.05\% + 135\text{mV}$
	Current	$\leq 0.1\% + 240\text{mA}$
Setup stability-8h (% of Output +Offset)	Voltage	$\leq 0.05\% + 135\text{mV}$
	Current	$\leq 0.1\% + 240\text{mA}$
Readback stability-30min (% of Output +Offset)	Voltage	$\leq 0.05\% + 135\text{mV}$
	Current	$\leq 0.1\% + 240\text{mA}$
Readback stability-8h (% of Output +Offset)	Voltage	$\leq 0.05\% + 135\text{mV}$
	Current	$\leq 0.1\% + 240\text{mA}$
Efficiency	80%	
Remote Sense Compensation Voltage	3V	
Command Response Time	20mS	
Power Factor	0.99	
Maximum input current ⁸	57A	
Maximum input apparent power	30400VA	
Storage temperature	$-10^{\circ}\text{C} \sim 70^{\circ}\text{C}$	
Protective function	Source OVP, OCP, OPP and Load OCP, OPP, OTP, Vsense reversed	
standard Interface	USB/RS232/CAN/GPIB/LAN	
Isolation (output to ground)	500V	

Parameter	IT6584C Version: V1.4
Parallel Number	≤8
Parallel Number of Power Dissipater	8/16/24
Working temperature	0 ~ 40°C
Dimension (mm)	550mmW×1289.3mmH×834.8mmD
Weight(net)	248Kg

5.1.27 IT6594C

Parameter	IT6594C Version: V1.4	
Output Rating (0 °C-40 °C)	Output Voltage	0 ~ 360V
	Output Current	0 ~ 300A
	Internal Sink Current ¹	0 ~ 125A
	External Sink Current ¹	0 ~ 300A
	Output Power	0 ~ 30KW
	Internal Sink Power ¹	0 ~ 1500W
	External Sink Power ¹	0 ~ 90KW
Output Resistance	Range	0 ~ 4.32Ω
	Accuracy ²	0.25%+135mΩ*A
	Resolution	1mΩ
Line regulation ±(% of Output+Offset)	Voltage	≤0.01%+40mV
	Current	≤0.01%+150mA
Load regulation ±(% of Output+Offset)	Voltage	≤0.01%+135mV
	Current	≤0.05%+300mA
Setup Resolution	Voltage	10mV
	Current	100mA
	Power	0.1W
Read Back Resolution	Voltage	10mV
	Current	100mA
	Power	0.1W
Setup Accuracy ³	Voltage	≤0.05%+135mV

Parameter		IT6594C Version: V1.4
(within 12 months, 25°C ±5°C) ±(%of Output+Offset)	Current	≤0.2%+300mA
	Power	1%+300W
Read Back Accuracy ⁴ (within 12 months, 25°C ±5°C) ±(%of Output+Offset)	Voltage	≤0.05%+135mV
	Current	≤0.2%+300mA
	Power	1%+300W
Ripple (20Hz -20MHz)	Voltage	≤360mVp-p
	Current	≤0.05%+300mArms
Setup Temperature Coefficient (%of Output/°C+Offset)	Voltage	≤0.01%+135mV
	Current	≤0.02%+300mA
Read Back Temperature Coefficient (%of Output/°C+Offset)	Voltage	≤0.01%+135mV
	Current	≤0.02%+300mA
Rise time(no load) ⁵	Voltage	≤50ms
Rise time(full load) ⁵	Voltage	≤80ms
Fall time(no load) ⁵	Voltage	≤250ms
Fall time(full load) ⁵	Voltage	≤55ms
Current seamless switching ⁶	-90% ~ 90%	≤500ms
	90% ~ -90%	≤500ms
Transient Response Time	Voltage	≤3ms
AC Input ⁷	Voltage	380V±10%(Three-phase five wire)
	Frequency	47Hz ~ 63Hz
Setup stability-30min (%of Output +Offset)	Voltage	≤0.05%+135mV
	Current	≤0.1%+300mA
Setup stability-8h (%of Output +Offset)	Voltage	≤0.05%+135mV
	Current	≤0.1%+300mA
Readback stability-30min (%of Output +Offset)	Voltage	≤0.05%+135mV
	Current	≤0.1%+300mA
Readback stability-8h (%of Output +Offset)	Voltage	≤0.05%+135mV
	Current	≤0.1%+300mA
Efficiency	80%	
Remote Sense Compensation Voltage	3V	
Command Response Time	20mS	

Parameter		IT6594C Version: V1.4
Power Factor		0.99
Maximum input current ⁸		76A
Maximum input apparent power		38000VA
Storage temperature		-10°C ~ 70°C
Protective function		Source OVP, OCP, OPP and Load OCP, OPP, OTP, Vsense reversed
standard Interface		USB/RS232/CAN/GPIB/LAN
Isolation (output to ground)		500V
Parallel Number		≤8
Parallel Number of Power Dissipater		10/20/30
Working temperature		0 ~ 40°C
Dimension (mm)		550mmW×1289.3mmH×834.8mmD
Weight(net)		284Kg

5.1.28 IT6515C

Parameter		IT6515C Version: V1.4
Output Rating (0 °C-40 °C)	Output Voltage	0 ~ 500V
	Output Current	0 ~ 20A
	Internal Sink Current ¹	0 ~ 8A
	External Sink Current ¹	0 ~ 20A
	Output Power	0 ~ 1800W
	Internal Sink Power ¹	0 ~ 150W
	External Sink Power ¹	0 ~ 5400W
Output Resistance	Range	0 ~ 138.88Ω
	Accuracy ²	0.25%+200mΩ
	Resolution	10mΩ
Line regulation ±(% of Output+Offset)	Voltage	≤0.01%+50mV
	Current	≤0.01%+10mA

Parameter		IT6515C Version: V1.4
Load regulation \pm (% of Output+Offset)	Voltage	$\leq 0.01\% + 100\text{mV}$
	Current	$\leq 0.05\% + 20\text{mA}$
Setup Resolution	Voltage	100mV
	Current	10mA
	Power	0.1W
Read Back Resolution	Voltage	100mV
	Current	10mA
	Power	0.1W
Setup Accuracy (within 12 months, 25°C \pm 5°C) \pm (% of Output+Offset)	Voltage	$\leq 0.05\% + 200\text{mV}$
	Current	$\leq 0.2\% + 20\text{mA}$
	Power	$\leq 1\% + 30\text{W}$
Read Back Accuracy (within 12 months, 25°C \pm 5°C) \pm (% of Output+Offset)	Voltage	$\leq 0.05\% + 200\text{mV}$
	Current	$\leq 0.2\% + 20\text{mA}$
	Power	$\leq 1\% + 30\text{W}$
Ripple (20Hz -20MHz)	Voltage	$\leq 500\text{mVp-p}$
	Current	$\leq 40\text{mA}_{\text{rms}}$
Setup Temperature Coefficient (% of Output/°C+Offset)	Voltage	$\leq 0.03\% + 100\text{mV}$
	Current	$\leq 0.1\% + 30\text{mA}$
Read Back Temperature Coefficient (% of Output/°C+Offset)	Voltage	$\leq 0.03\% + 100\text{mV}$
	Current	$\leq 0.1\% + 30\text{mA}$
Rise time(no load) ⁵	Voltage	$\leq 40\text{ms}$
Rise time(full load) ⁵	Voltage	$\leq 70\text{ms}$
Fall time(no load) ⁵	Voltage	$\leq 100\text{ms}$
Fall time(full load) ⁵	Voltage	$\leq 50\text{ms}$
Current seamless switching ⁶	-90% ~ 90%	$\leq 20\text{ms}$
	90% ~ -90%	$\leq 20\text{ms}$
Transient Response Time	Voltage	$\leq 2\text{ms}$
AC Input ⁷	Voltage	220V \pm 10%
	Frequency	47Hz ~ 63Hz
Setup stability-30min (% of Output +Offset)	Voltage	$\leq 0.03\% + 100\text{mV}$
	Current	$\leq 0.1\% + 30\text{mA}$
Setup stability-8h (% of Output +Offset)	Voltage	$\leq 0.03\% + 100\text{mV}$

Parameter		IT6515C Version: V1.4
	Current	$\leq 0.1\% + 30\text{mA}$
Readback stability-30min (%of Output +Offset)	Voltage	$\leq 0.03\% + 100\text{mV}$
	Current	$\leq 0.1\% + 30\text{mA}$
Readback stability-8h (%of Output +Offset)	Voltage	$\leq 0.03\% + 100\text{mV}$
	Current	$\leq 0.1\% + 30\text{mA}$
Efficiency	90%(150V/20A) ~ 93%(500V/6A)	
Remote Sense Compensation Voltage	5V	
Command Response Time	20mS	
Power Factor	0.99	
Ma Maximum input current ⁸	10A	
Maximum input apparent power	2100VA	
Storage temperature	$-10^{\circ}\text{C} \sim 70^{\circ}\text{C}$	
Protective function	Source OVP, OCP, OPP and Load OCP, OPP, OTP, Vsense reversed	
standard Interface	USB/RS232/CAN/GPIB/LAN	
Isolation (output to ground)	500V	
Parallel Number	≤ 8	
Parallel Number of Power Dissipater	1/2/3	
Working temperature	$0 \sim 40^{\circ}\text{C}$	
Dimension (mm)	483mmW×105.4mmH×640.8mmD	
Weight(net)	17Kg	

5.1.29 IT6525C

Parameter		IT6525C Version: V1.4
Output Rating (0 °C-40 °C)	Output Voltage	0 ~ 500V
	Output Current	0 ~ 20A
	Internal Sink Current ¹	0 ~ 8A

Parameter		IT6525C Version: V1.4
	External Sink Current ¹	0 ~ 20A
	Output Power	0 ~ 3000W
	Internal Sink Power ¹	0 ~ 150W
	External Sink Power ¹	0 ~ 9KW
Output Resistance	Range	0 ~ 83.33Ω
	Accuracy ²	0.25%+200mΩ
	Resolution	10mΩ
Line regulation ±(% of Output+Offset)	Voltage	≤0.01%+50mV
	Current	≤0.01%+10mA
Load regulation ±(% of Output+Offset)	Voltage	≤0.01%+100mV
	Current	≤0.05%+20mA
Setup Resolution	Voltage	100mV
	Current	10mA
	Power	0.1W
Read Back Resolution	Voltage	100mV
	Current	10mA
	Power	0.1W
Setup Accuracy (within 12 months, 25°C±5°C) ±(% of Output+Offset)	Voltage	≤0.05%+200mV
	Current	≤0.2%+20mA
	Power	≤1%+30W
Read Back Accuracy (within 12 months, 25°C±5°C) ±(% of Output+Offset)	Voltage	≤0.05%+200mV
	Current	≤0.2%+20mA
	Power	≤1%+30W
Ripple (20Hz -20MHz)	Voltage	≤500mVp-p
	Current	≤40mArms
Setup Temperature Coefficient (% of Output/°C+Offset)	Voltage	≤0.03 %+100mV
	Current	≤0.1%+30mA
Read Back Temperature Coefficient (% of Output/°C+Offset)	Voltage	≤0.03%+100mV
	Current	≤0.1%+30mA
Rise time(no load) ⁵	Voltage	≤40ms
Rise time(full load) ⁵	Voltage	≤70ms

Parameter		IT6525C Version: V1.4
Fall time(no load) ⁵	Voltage	≤100ms
Fall time(full load) ⁵	Voltage	≤25ms
Current seamless switching ⁶	-90% ~ 90%	≤20ms
	90% ~ -90%	≤20ms
Transient Response Time	Voltage	≤2ms
AC Input ⁷	Voltage	220V±10%
	Frequency	47Hz ~ 63Hz
Setup stability-30min (%of Output +Offset)	Voltage	≤0.03%+100mV
	Current	≤0.1%+30mA
Setup stability-8h (%of Output +Offset)	Voltage	≤0.03%+100mV
	Current	≤0.1%+30mA
Readback stability-30min (%of Output +Offset)	Voltage	≤0.03%+100mV
	Current	≤0.1%+30mA
Readback stability-8h (%of Output +Offset)	Voltage	≤0.03%+100mV
	Current	≤0.1%+30mA
Efficiency	90%(150V/20A) ~ 93%(500V/6A)	
Remote Sense Compensation Voltage	5V	
Command Response Time	20mS	
Power Factor	0.99	
Maximum input current ⁸	19A	
Maximum input apparent power	3800VA	
Storage temperature	-10°C ~ 70°C	
Protective function	Source OVP, OCP, OPP and Load OCP, OPP, OTP, Vsense reversed	
standard Interface	USB/RS232/CAN/GPIB/LAN	
Isolation (output to ground)	500V	
Parallel Number	≤8	
Parallel Number of Power Dissipater	1/2/3	
Working temperature	0 ~ 40°C	

Parameter		IT6525C Version: V1.4
Dimension (mm)	483mmW×105.4mmH×640.8mmD	
Weight(net)	17Kg	

5.1.30 IT6535C

Parameter		IT6535C Version: V1.4
Output Rating (0 °C-40 °C)	Output Voltage	0 ~ 500V
	Output Current	0 ~ 40A
	Internal Sink Current ¹	0 ~ 16A
	External Sink Current ¹	0 ~ 40A
	Output Power	0 ~ 6KW
	Internal Sink Power ¹	0 ~ 300W
	External Sink Power ¹	0 ~ 18KW
Output Resistance	Range	0 ~ 41.66Ω
	Accuracy ²	0.25%+200mΩ
	Resolution	10mΩ
Line regulation ±(%of Output+Offset)	Voltage	≤0.01%+50mV
	Current	≤0.01%+20mA
Load regulation ±(%of Output+Offset)	Voltage	≤0.01%+100mV
	Current	≤0.05%+40mA
Setup Resolution	Voltage	100mV
	Current	10mA
	Power	0.1W
Read Back Resolution	Voltage	100mV
	Current	10mA
	Power	0.1W
Setup Accuracy (within 12 months, 25°C ±5°C) ±(%of Output+Offset)	Voltage	≤0.05%+200mV
	Current	≤0.2%+40mA
	Power	≤1%+60W
Read Back Accuracy (within 12 months, 25°C ±5°C) ±(%of Output+Offset)	Voltage	≤0.05%+200mV
	Current	≤0.2%+40mA
	Power	≤1%+60W

Parameter		IT6535C Version: V1.4
Ripple (20Hz -20MHz)	Voltage	≤500mVp-p
	Current	≤80mArms
Setup Temperature Coefficient (%of Output/°C+Offset)	Voltage	≤0.03 %+100mV
	Current	≤0.1%+60mA
Read Back Temperature Coefficient (%of Output/°C+Offset)	Voltage	≤0.03%+100mV
	Current	≤0.1%+60mA
Rise time(no load) ⁵	Voltage	≤40ms
Rise time(full load) ⁵	Voltage	≤70ms
Fall time(no load) ⁵	Voltage	≤100ms
Fall time(full load) ⁵	Voltage	≤25ms
Current seamless switching ⁶	-90% ~ 90%	≤40ms
	90% ~ -90%	≤40ms
Transient Response Time	Voltage	≤2ms
AC Input ⁷	Voltage	220V±10%
	Frequency	47Hz ~ 63Hz
Setup stability-30min (%of Output +Offset)	Voltage	≤0.03%+100mV
	Current	≤0.1%+60mA
Setup stability-8h (%of Output +Offset)	Voltage	≤0.03%+100mV
	Current	≤0.1%+60mA
Readback stability-30min (%of Output +Offset)	Voltage	≤0.03%+100mV
	Current	≤0.1%+60mA
Readback stability-8h (%of Output +Offset)	Voltage	≤0.03%+100mV
	Current	≤0.1%+60mA
Efficiency	90%(150V/40A) ~ 93%(500V/12A)	
Remote Sense Compensation Voltage	5V	
Command Response Time	20mS	
Power Factor	0.99	
Maximum input current ⁸	38A	
Maximum input apparent power	7600VA	
Storage temperature	-10°C ~ 70°C	
Protective function	Source OVP, OCP, OPP and Load OCP, OPP, OTP, Vsense reversed	

Parameter	IT6535C Version: V1.4
standard Interface	USB/RS232/CAN/GPIB/LAN
Isolation (output to ground)	500V
Parallel Number	≤8
Parallel Number of Power Dissipater	2/4/6
Working temperature	0 ~ 40°C
Dimension (mm)	483mmW×194mmH×640.8mmD
Weight(net)	35Kg

5.1.31 IT6545C

Parameter	IT6545C Version: V1.4	
Output Rating (0 °C-40 °C)	Output Voltage	0 ~ 500V
	Output Current	0 ~ 60A
	Internal Sink Current ¹	0 ~ 24A
	External Sink Current ¹	0 ~ 60A
	Output Power	0 ~ 9KW
	Internal Sink Power ¹	0 ~ 450W
	External Sink Power ¹	0 ~ 27KW
Output Resistance	Range	0 ~ 27.77Ω
	Accuracy ²	0.25%+200mΩ
	Resolution	10mΩ
Line regulation ±(% of Output+Offset)	Voltage	≤0.01%+50mV
	Current	≤0.01%+30mA
Load regulation ±(% of Output+Offset)	Voltage	≤0.01%+100mV
	Current	≤0.05%+60mA
Setup Resolution	Voltage	100mV
	Current	10mA
	Power	0.1W
Read Back Resolution	Voltage	100mV
	Current	10mA
	Power	0.1W
Setup Accuracy	Voltage	≤0.05%+200mV

Parameter		IT6545C Version: V1.4
(within 12 months, 25°C ±5°C) ±(% of Output+Offset)	Current	≤0.2%+60mA
	Power	≤1%+90W
Read Back Accuracy (within 12 months, 25°C ±5°C) ±(% of Output+Offset)	Voltage	≤0.05%+200mV
	Current	≤0.2%+60mA
	Power	≤1%+90W
Ripple (20Hz -20MHz)	Voltage	≤500mVp-p
	Current	≤120mArms
Setup Temperature Coefficient (% of Output/°C+Offset)	Voltage	≤0.03 %+100mV
	Current	≤0.1%+90mA
Read Back Temperature Coefficient (% of Output/°C+Offset)	Voltage	≤0.03%+100mV
	Current	≤0.1%+90mA
Rise time(no load) ⁵	Voltage	≤40ms
Rise time(full load) ⁵	Voltage	≤70ms
Fall time(no load) ⁵	Voltage	≤100ms
Fall time(full load) ⁵	Voltage	≤25ms
Current seamless switching ⁶	-90% ~ 90%	≤60ms
	90% ~ -90%	≤60ms
Transient Response Time	Voltage	≤2ms
AC Input ⁷	Voltage	220V±10%
	Frequency	47Hz ~ 63Hz
Setup stability-30min (% of Output +Offset)	Voltage	≤0.03%+100mV
	Current	≤0.1%+90mA
Setup stability-8h (% of Output +Offset)	Voltage	≤0.03%+100mV
	Current	≤0.1%+90mA
Readback stability-30min (% of Output +Offset)	Voltage	≤0.03%+100mV
	Current	≤0.1%+90mA
Readback stability-8h (% of Output +Offset)	Voltage	≤0.03%+100mV
	Current	≤0.1%+90mA
Efficiency	90%(150V/60A) ~ 93%(500V/18A)	
Remote Sense Compensation Voltage	5V	
Command Response Time	20mS	

Parameter		IT6545C Version: V1.4
Power Factor		0.99
Maximum input current ⁸		19A
Maximum input apparent power		11400VA
Storage temperature		-10°C ~ 70°C
Protective function		Source OVP, OCP, OPP and Load OCP, OPP, OTP, Vsense reversed
standard Interface		USB/RS232/CAN/GPIB/LAN
Isolation (output to ground)		500V
Parallel Number		≤8
Parallel Number of Power Dissipater		3/6/9
Working temperature		0 ~ 40°C
Dimension (mm)		483mmW×283.2mmH×640.8mmD
Weight(net)		53Kg

5.1.32 IT6555C

Parameter		IT6555C Version: V1.4
Output Rating (0 °C-40 °C)	Output Voltage	0 ~ 500V
	Output Current	0 ~ 80A
	Internal Sink Current ¹	0 ~ 32A
	External Sink Current ¹	0 ~ 80A
	Output Power	0 ~ 12KW
	Internal Sink Power ¹	0 ~ 600W
	External Sink Power ¹	0 ~ 36KW
Output Resistance	Range	0 ~ 20.83Ω
	Accuracy ²	0.25%+200mΩ
	Resolution	10mΩ
Line regulation ±(% of Output+Offset)	Voltage	≤0.01%+50mV
	Current	≤0.01%+40mA
Load regulation ±(% of Output+Offset)	Voltage	≤0.01%+100mV

Parameter		IT6555C Version: V1.4
	Current	$\leq 0.05\% + 80\text{mA}$
Setup Resolution	Voltage	100mV
	Current	10mA
	Power	0.1W
Read Back Resolution	Voltage	100mV
	Current	10mA
	Power	0.1W
Setup Accuracy (within 12 months, 25°C ±5°C) ±(% of Output+Offset)	Voltage	$\leq 0.05\% + 200\text{mV}$
	Current	$\leq 0.2\% + 80\text{mA}$
	Power	$\leq 1\% + 120\text{W}$
Read Back Accuracy (within 12 months, 25°C ±5°C) ±(% of Output+Offset)	Voltage	$\leq 0.05\% + 200\text{mV}$
	Current	$\leq 0.2\% + 80\text{mA}$
	Power	$\leq 1\% + 120\text{W}$
Ripple (20Hz -20MHz)	Voltage	$\leq 500\text{mVp-p}$
	Current	$\leq 160\text{mA}_{\text{rms}}$
Setup Temperature Coefficient (% of Output/°C+Offset)	Voltage	$\leq 0.03\% + 100\text{mV}$
	Current	$\leq 0.1\% + 120\text{mA}$
Read Back Temperature Coefficient (% of Output/°C+Offset)	Voltage	$\leq 0.03\% + 100\text{mV}$
	Current	$\leq 0.1\% + 120\text{mA}$
Rise time(no load) ⁵	Voltage	$\leq 40\text{ms}$
Rise time(full load) ⁵	Voltage	$\leq 70\text{ms}$
Fall time(no load) ⁵	Voltage	$\leq 100\text{ms}$
Fall time(full load) ⁵	Voltage	$\leq 25\text{ms}$
Current seamless switching ⁶	-90% ~ 90%	$\leq 80\text{ms}$
	90% ~ -90%	$\leq 80\text{ms}$
Transient Response Time	Voltage	$\leq 2\text{ms}$
AC Input ⁷	Voltage	380Vac±10%(Three-phase five wire)
	Frequency	47Hz ~ 63Hz
Setup stability-30min (% of Output +Offset)	Voltage	$\leq 0.03\% + 100\text{mV}$
	Current	$\leq 0.1\% + 120\text{mA}$
Setup stability-8h (% of Output +Offset)	Voltage	$\leq 0.03\% + 100\text{mV}$
	Current	$\leq 0.1\% + 120\text{mA}$
Readback stability-30min	Voltage	$\leq 0.03\% + 100\text{mV}$

Parameter		IT6555C Version: V1.4
(%of Output +Offset)	Current	$\leq 0.1\% + 120\text{mA}$
Readback stability-8h (%of Output +Offset)	Voltage	$\leq 0.03\% + 100\text{mV}$
	Current	$\leq 0.1\% + 120\text{mA}$
Efficiency	90%(150V/80A) ~ 93%(500V/24A)	
Remote Sense Compensation Voltage	5V	
Command Response Time	20mS	
Power Factor	0.99	
Maximum input current ⁸	38A	
Maximum input apparent power	15200VA	
Storage temperature	-10°C ~ 70°C	
Protective function	Source OVP, OCP, OPP and Load OCP, OPP, OTP, Vsense reversed	
standard Interface	USB/RS232/CAN/GPIB/LAN	
Isolation (output to ground)	500V	
Parallel Number	≤ 8	
Parallel Number of Power Dissipater	4/8/12	
Working temperature	0 ~ 40°C	
Dimension (mm)	554mmW×902mmH×807.5mmD (ITECH 15UCabinet)	
Weight(net)	119Kg	

5.1.33 IT6565C

Parameter		IT6565C Version: V1.4
Output Rating (0 °C-40 °C)	Output Voltage	0 ~ 500V
	Output Current	0 ~ 100A
	Internal Sink Current ¹	0 ~ 40A
	External Sink Current ¹	0 ~ 100A
	Output Power	0 ~ 15KW
	Internal Sink Power ¹	0 ~ 750W

Parameter		IT6565C Version: V1.4
	External Sink Power ¹	0 ~ 45KW
Output Resistance	Range	0 ~ 16.667Ω
	Accuracy ²	0.25%+200mΩ
	Resolution	10mΩ
Line regulation ±(% of Output+Offset)	Voltage	≤0.01%+50mV
	Current	≤0.01%+50mA
Load regulation ±(% of Output+Offset)	Voltage	≤0.01%+100mV
	Current	≤0.05%+100mA
Setup Resolution	Voltage	100mV
	Current	10mA
	Power	0.1W
Read Back Resolution	Voltage	100mV
	Current	10mA
	Power	0.1W
Setup Accuracy (within 12 months, 25°C ±5°C) ±(% of Output+Offset)	Voltage	≤0.05%+200mV
	Current	≤0.2%+100mA
	Power	≤1%+150W
Read Back Accuracy (within 12 months, 25°C ±5°C) ±(% of Output+Offset)	Voltage	≤0.03%+200mV
	Current	≤0.2%+100mA
	Power	≤1%+150W
Ripple (20Hz -20MHz)	Voltage	≤500mVp-p
	Current	≤200mA _{rms}
Setup Temperature Coefficient (% of Output/°C+Offset)	Voltage	≤0.03 %+100mV
	Current	≤0.1%+150mA
Read Back Temperature Coefficient (% of Output/°C+Offset)	Voltage	≤0.03%+100mV
	Current	≤0.1%+150mA
Rise time(no load) ⁵	Voltage	≤40ms
Rise time(full load) ⁵	Voltage	≤70ms
Fall time(no load) ⁵	Voltage	≤100ms
Fall time(full load) ⁵	Voltage	≤25ms
Current seamless switching ⁶	-90% ~ 90%	≤100ms
	90% ~ -90%	≤100ms

Parameter		IT6565C Version: V1.4
Transient Response Time	Voltage	≤2ms
AC Input ⁷	Voltage	380Vac±10%(Three-phase five wire)
	Frequency	47Hz ~ 63Hz
Setup stability-30min (%of Output +Offset)	Voltage	≤0.03%+100mV
	Current	≤0.1%+150mA
Setup stability-8h (%of Output +Offset)	Voltage	≤0.03%+100mV
	Current	≤0.1%+150mA
Readback stability-30min (%of Output +Offset)	Voltage	≤0.03%+100mV
	Current	≤0.1%+150mA
Readback stability-8h (%of Output +Offset)	Voltage	≤0.03%+100mV
	Current	≤0.1%+150mA
Efficiency	90%(150V/20A) ~ 93%(500V/6A)	
Remote Sense Compensation Voltage	5V	
Command Response Time	20mS	
Power Factor	0.99	
Maximum input current ⁸	38A	
Maximum input apparent power	19000VA	
Storage temperature	-10°C ~ 70°C	
Protective function	Source OVP, OCP, OPP and Load OCP, OPP, OTP,Vsense reversed	
standard Interface	USB/RS232/CAN/GPIB/LAN	
Isolation (output to ground)	500V	
Parallel Number	≤8	
Parallel Number of Power Dissipater	5/10/15	
Working temperature	0 ~ 40°C	
Dimension (mm)	554mmW×902mmH×807.5mmD (ITECH 15UCabinet)	
Weight(net)	137Kg	

5.1.34 IT6575C

Parameter		IT6575C Version: V1.4
Output Rating (0 °C-40 °C)	Output Voltage	0 ~ 500V
	Output Current	0 ~ 140A
	Internal Sink Current ¹	0 ~ 56A
	External Sink Current ¹	0 ~ 140A
	Output Power	0 ~ 21KW
	Internal Sink Power ¹	0 ~ 1050W
	External Sink Power ¹	0 ~ 63KW
Output Resistance	Range	0 ~ 11.90Ω
	Accuracy ²	0.25%+200mΩ
	Resolution	10mΩ
Line regulation ±(% of Output+Offset)	Voltage	≤0.01%+50mV
	Current	≤0.01%+70mA
Load regulation ±(% of Output+Offset)	Voltage	≤0.01%+100mV
	Current	≤0.05%+140mA
Setup Resolution	Voltage	100mV
	Current	10mA
	Power	0.1W
Read Back Resolution	Voltage	100mV
	Current	10mA
	Power	0.1W
Setup Accuracy (within 12 months, 25°C±5°C) ±(% of Output+Offset)	Voltage	≤0.05%+200mV
	Current	≤0.2%+140mA
	Power	≤1%+210W
Read Back Accuracy (within 12 months, 25°C±5°C) ±(% of Output+Offset)	Voltage	≤0.05%+200mV
	Current	≤0.2%+140mA
	Power	≤1%+210W
Ripple (20Hz -20MHz)	Voltage	≤500mVp-p
	Current	≤280mA _{rms}
Setup Temperature Coefficient	Voltage	≤0.03 %+100mV

Parameter		IT6575C Version: V1.4
(%of Output/°C+Offset)	Current	$\leq 0.1\% + 210\text{mA}$
Read Back Temperature Coefficient (%of Output/°C+Offset)	Voltage	$\leq 0.03\% + 100\text{mV}$
	Current	$\leq 0.1\% + 210\text{mA}$
Rise time(no load) ⁵	Voltage	$\leq 40\text{ms}$
Rise time(full load) ⁵	Voltage	$\leq 70\text{ms}$
Fall time(no load) ⁵	Voltage	$\leq 100\text{ms}$
Fall time(full load) ⁵	Voltage	$\leq 25\text{ms}$
Current seamless switching ⁶	-90% ~ 90%	$\leq 140\text{ms}$
	90% ~ -90%	$\leq 140\text{ms}$
Transient Response Time	Voltage	$\leq 2\text{ms}$
AC Input ⁷	Voltage	380V \pm 10%(Three-phase five wire)
	Frequency	47Hz ~ 63Hz
Setup stability-30min (%of Output +Offset)	Voltage	$\leq 0.03\% + 100\text{mV}$
	Current	$\leq 0.1\% + 210\text{mA}$
Setup stability-8h (%of Output +Offset)	Voltage	$\leq 0.03\% + 100\text{mV}$
	Current	$\leq 0.1\% + 210\text{mA}$
Readback stability-30min (%of Output +Offset)	Voltage	$\leq 0.03\% + 100\text{mV}$
	Current	$\leq 0.1\% + 210\text{mA}$
Readback stability-8h (%of Output +Offset)	Voltage	$\leq 0.03\% + 100\text{mV}$
	Current	$\leq 0.1\% + 210\text{mA}$
Efficiency	90%(150V/140A) ~ 93%(500V/42A)	
Remote Sense Compensation Voltage	5V	
Command Response Time	20mS	
Power Factor	0.99	
Maximum input current ⁸	57A	
Maximum input apparent power	26600VA	
Storage temperature	-10°C ~ 70°C	
Protective function	Source OVP, OCP, OPP and Load OCP, OPP, OTP, Vsense reversed	
standard Interface	USB/RS232/CAN/GPIB/LAN	

Parameter	IT6575C Version: V1.4
Isolation (output to ground)	500V
Parallel Number	≤8
Parallel Number of Power Dissipater	7/14/21
Working temperature	0 ~ 40°C
Dimension (mm)	550mmW×1289.3mmH×834.8mmD(ITECH 24UCabinet)
Weight(net)	230Kg

5.1.35 IT6585C

Parameter	IT6585C Version: V1.4	
Output Rating (0 °C-40 °C)	Output Voltage	0 ~ 500V
	Output Current	0 ~ 160A
	Internal Sink Current ¹	0 ~ 64A
	External Sink Current ¹	0 ~ 160A
	Output Power	0 ~ 24KW
	Internal Sink Power ¹	0 ~ 1200W
	External Sink Power ¹	0 ~ 72KW
Output Resistance	Range	0 ~ 10.417Ω
	Accuracy ²	0.25%+200mΩ
	Resolution	10mΩ
Line regulation ±(% of Output+Offset)	Voltage	≤0.01%+50mV
	Current	≤0.01%+80mA
Load regulation ±(% of Output+Offset)	Voltage	≤0.01%+100mV
	Current	≤0.05%+160mA
Setup Resolution	Voltage	100mV
	Current	10mA
	Power	0.1W
Read Back Resolution	Voltage	100mV
	Current	10mA

Parameter		IT6585C Version: V1.4
	Power	0.1W
Setup Accuracy (within 12 months, 25°C ±5°C) ±(%of Output+Offset)	Voltage	≤0.05%+200mV
	Current	≤0.2%+160mA
	Power	≤1%+240W
Read Back Accuracy (within 12 months, 25°C ±5°C) ±(%of Output+Offset)	Voltage	≤0.05%+200mV
	Current	≤0.2%+160mA
	Power	≤1%+240W
Ripple (20Hz -20MHz)	Voltage	≤500mVp-p
	Current	≤320mArms
Setup Temperature Coefficient (%of Output/°C+Offset)	Voltage	≤0.03 %+100mV
	Current	≤0.1%+240mA
Read Back Temperature Coefficient (%of Output/°C+Offset)	Voltage	≤0.03%+100mV
	Current	≤0.1%+240mA
Rise time(no load) ⁵	Voltage	≤40ms
Rise time(full load) ⁵	Voltage	≤70ms
Fall time(no load) ⁵	Voltage	≤100ms
Fall time(full load) ⁵	Voltage	≤25ms
Current seamless switching ⁶	-90% ~ 90%	≤160ms
	90% ~ -90%	≤160ms
Transient Response Time	Voltage	≤2ms
AC Input ⁷	Voltage	380V±10%(Three-phase five wire)
	Frequency	47Hz ~ 63Hz
Setup stability-30min (%of Output +Offset)	Voltage	≤0.03%+100mV
	Current	≤0.1%+240mA
Setup stability-8h (%of Output +Offset)	Voltage	≤0.03%+100mV
	Current	≤0.1%+240mA
Readback stability-30min (%of Output +Offset)	Voltage	≤0.03%+100mV
	Current	≤0.1%+240mA
Readback stability-8h (%of Output +Offset)	Voltage	≤0.03%+100mV
	Current	≤0.1%+240mA
Efficiency	90%(150V/160A) ~ 93%(500V/48A)	

Parameter		IT6585C Version: V1.4
Remote Sense Compensation Voltage		5V
Command Response Time		20mS
Power Factor		0.99
Maximum input current ⁸		57A
Maximum input apparent power		30400VA
Storage temperature		-10°C ~ 70°C
Protective function		Source OVP, OCP, OPP and Load OCP, OPP, OTP, Vsense reversed
standard Interface		USB/RS232/CAN/GPIB/LAN
Isolation (output to ground)		500V
Parallel Number		≤8
Parallel Number of Power Dissipater		8/16/24
Working temperature		0 ~ 40°C
Dimension (mm)		550mmW×1289.3mmH×834.8mmD
Weight(net)		248Kg

5.1.36 IT6595C

Parameter		IT6595C Version: V1.4
Output Rating (0 °C-40 °C)	Output Voltage	0 ~ 500V
	Output Current	0 ~ 200A
	Internal Sink Current ¹	0 ~ 80A
	External Sink Current ¹	0 ~ 200A
	Output Power	0 ~ 30KW
	Internal Sink Power ¹	0 ~ 1500W
	External Sink Power ¹	0 ~ 90KW
Output Resistance	Range	0 ~ 8.33Ω
	Accuracy ²	0.25%+200mΩ

Parameter		IT6595C Version: V1.4
	Resolution	10mΩ
Line regulation ±(% of Output+Offset)	Voltage	≤0.01%+50mV
	Current	≤0.01%+100mA
Load regulation ±(% of Output+Offset)	Voltage	≤0.01%+100mV
	Current	≤0.05%+200mA
Setup Resolution	Voltage	100mV
	Current	10mA
	Power	0.1W
Read Back Resolution	Voltage	100mV
	Current	10mA
	Power	0.1W
Setup Accuracy (within 12 months, 25°C ±5°C) ±(% of Output+Offset)	Voltage	≤0.05%+200mV
	Current	≤0.2%+200mA
	Power	≤1%+300W
Read Back Accuracy (within 12 months, 25°C ±5°C) ±(% of Output+Offset)	Voltage	≤0.05%+200mV
	Current	≤0.2%+200mA
	Power	≤1%+300W
Ripple (20Hz -20MHz)	Voltage	≤500mVp-p
	Current	≤400mArms
Setup Temperature Coefficient (% of Output/°C+Offset)	Voltage	≤0.03 %+100mV
	Current	≤0.1%+300mA
Read Back Temperature Coefficient (% of Output/°C+Offset)	Voltage	≤0.03%+100mV
	Current	≤0.1%+300mA
Rise time(no load) ⁵	Voltage	≤40ms
Rise time(full load) ⁵	Voltage	≤70ms
Fall time(no load) ⁵	Voltage	≤100ms
Fall time(full load) ⁵	Voltage	≤25ms
Current seamless switching ⁶	-90% ~ 90%	≤200ms
	90% ~ -90%	≤200ms
Transient Response Time	Voltage	≤2ms
AC Input ⁷	Voltage	380V±10%(Three-phase five wire)
	Frequency	47Hz ~ 63Hz
Setup stability-30min	Voltage	≤0.03%+100mV

Parameter		IT6595C Version: V1.4
(%of Output +Offset)	Current	$\leq 0.1\% + 300\text{mA}$
Setup stability-8h (%of Output +Offset)	Voltage	$\leq 0.03\% + 100\text{mV}$
	Current	$\leq 0.1\% + 300\text{mA}$
Readback stability-30min (%of Output +Offset)	Voltage	$\leq 0.03\% + 100\text{mV}$
	Current	$\leq 0.1\% + 300\text{mA}$
Readback stability-8h (%of Output +Offset)	Voltage	$\leq 0.03\% + 100\text{mV}$
	Current	$\leq 0.1\% + 300\text{mA}$
Efficiency	90%(150V/200A) ~ 93%(500V/60A)	
Remote Sense Compensation Voltage	5V	
Command Response Time	20mS	
Power Factor	0.99	
Maximum input current ⁸	76A	
Maximum input apparent power	38000VA	
Storage temperature	-10°C ~ 70°C	
Protective function	Source OVP, OCP, OPP and Load OCP, OPP, OTP, Vsense reversed	
standard Interface	USB/RS232/CAN/GPIB/LAN	
Isolation (output to ground)	500V	
Parallel Number	≤ 8	
Parallel Number of Power Dissipater	10/20/30	
Working temperature	0 ~ 40°C	
Dimension (mm)	550mmW×1289.3mmH×834.8mmD	
Weight(net)	284Kg	

5.1.37 IT6516C

Parameter		IT6516C Version: V1.4
Output Rating (0 °C-40 °C)	Output Voltage	0 ~ 750V
	Output Current	0 ~ 15A

Parameter		IT6516C Version: V1.4
	Internal Sink Current ¹	0 ~ 5A
	External Sink Current ¹	0 ~ 15A
	Output Power	0 ~ 1800W
	Internal Sink Power ¹	0 ~ 150W
	External Sink Power ¹	0 ~ 5.4KW
Output Resistance	Range	0 ~ 312.5Ω
	Accuracy ²	0.25%+300mΩ
	Resolution	10mΩ
Line regulation ±(% of Output+Offset)	Voltage	≤0.01%+75mV
	Current	≤0.1%+7.5mA
Load regulation ±(% of Output+Offset)	Voltage	≤0.01%+200mV
	Current	≤0.05%+15mA
Setup Resolution	Voltage	100mV
	Current	1mA
	Power	0.1W
Read Back Resolution	Voltage	100mV
	Current	1mA
	Power	0.1W
Setup Accuracy (within 12 months, 25°C ±5°C) ±(% of Output+Offset)	Voltage	≤0.05%+300mV
	Current	≤0.2%+15mA
	Power	≤1%+30W
Read Back Accuracy (within 12 months, 25°C ±5°C) ±(% of Output+Offset)	Voltage	≤0.05%+300mV
	Current	≤0.2%+15mA
	Power	≤1%+30W
Ripple (20Hz -20MHz)	Voltage	≤750mVp-p
	Current	≤30Arms
Setup Temperature Coefficient (% of Output/°C+Offset)	Voltage	≤0.03 %+100mV
	Current	≤0.1%+30mA
Read Back Temperature Coefficient (% of Output/°C+Offset)	Voltage	≤0.03%+100mV
	Current	≤0.1%+30mA
Rise time(no load) ⁵	Voltage	≤50ms

Parameter		IT6516C Version: V1.4
Rise time(full load) ⁵	Voltage	≤80ms
Fall time(no load) ⁵	Voltage	≤250ms
Fall time(full load) ⁵	Voltage	≤40ms
Current seamless switching ⁶	-90% ~ 90%	≤35ms
	90% ~ -90%	≤35ms
Transient Response Time	Voltage	≤3.5ms
AC Input ⁷	Voltage	220V±10%
	Frequency	47Hz ~ 63Hz
Setup stability-30min (%of Output +Offset)	Voltage	≤0.03%+100mV
	Current	≤0.1%+30mA
Setup stability-8h (%of Output +Offset)	Voltage	≤0.03%+100mV
	Current	≤0.1%+30mA
Readback stability-30min (%of Output +Offset)	Voltage	≤0.03%+100mV
	Current	≤0.1%+30mA
Readback stability-8h (%of Output +Offset)	Voltage	≤0.03%+100mV
	Current	≤0.1%+30mA
Efficiency	91.5%(200V/15A) ~ 93.5%(750V/4A)	
Remote Sense Compensation Voltage	5V	
Command Response Time	20mS	
Power Factor	0.99	
Maximum input current ⁸	10A	
Maximum input apparent power	2000VA	
Storage temperature	-10°C ~ 70°C	
Protective function	Source OVP, OCP, OPP and Load OCP, OPP, OTP, Vsense reversed	
standard Interface	USB/RS232/CAN/GPIB/LAN	
Isolation (output to ground)	750V	
Parallel Number	≤8	
Parallel Number of Power Dissipater	1/2/3	
Working temperature	0 ~ 40°C	

Parameter		IT6516C Version: V1.4
Dimension (mm)	483mmW×105.4mmH×640.8mmD	
Weight(net)	17Kg	

5.1.38 IT6526C

Parameter		IT6526C Version: V1.4
Output Rating (0 °C-40 °C)	Output Voltage	0 ~ 750V
	Output Current	0 ~ 15A
	Internal Sink Current ¹	0 ~ 5A
	External Sink Current ¹	0 ~ 15A
	Output Power	0 ~ 3000W
	Internal Sink Power ¹	0 ~ 150W
	External Sink Power ¹	0 ~ 9KW
Output Resistance	Range	0 ~ 188Ω
	Accuracy ²	0.25%+300mΩ
	Resolution	10mΩ
Line regulation ±(% of Output+Offset)	Voltage	≤0.01%+75mV
	Current	≤0.1%+7.5mA
Load regulation ±(% of Output+Offset)	Voltage	≤0.01%+200mV
	Current	≤0.05%+15mA
Setup Resolution	Voltage	100mV
	Current	1mA
	Power	0.1W
Read Back Resolution	Voltage	100mV
	Current	1mA
	Power	0.1W
Setup Accuracy (within 12 months, 25°C ±5°C) ±(% of Output+Offset)	Voltage	≤0.05%+300mV
	Current	≤0.2%+15mA
	Power	≤1%+30W
Read Back Accuracy (within 12 months, 25°C ±5°C)	Voltage	≤0.05%+300mV
	Current	≤0.2%+15mA

Parameter		IT6526C Version: V1.4
±(% of Output+Offset)	Power	≤1%+30W
Ripple (20Hz -20MHz)	Voltage	≤750mVp-p
	Current	≤30mArms
Setup Temperature Coefficient (% of Output/°C+Offset)	Voltage	≤0.03 %+100mV
	Current	≤0.1%+30mA
Read Back Temperature Coefficient (% of Output/°C+Offset)	Voltage	≤0.03%+100mV
	Current	≤0.1%+30mA
Rise time(no load) ⁵	Voltage	≤50ms
Rise time(full load) ⁵	Voltage	≤80ms
Fall time(no load) ⁵	Voltage	≤250ms
Fall time(full load) ⁵	Voltage	≤20ms
Current seamless switching ⁶	-90% ~ 90%	≤35ms
	90% ~ -90%	≤35ms
Transient Response Time	Voltage	≤3.5ms
AC Input ⁷	Voltage	220V±10%
	Frequency	47Hz ~ 63Hz
Setup stability-30min (%of Output +Offset)	Voltage	≤0.03%+100mV
	Current	≤0.1%+30mA
Setup stability-8h (%of Output +Offset)	Voltage	≤0.03%+100mV
	Current	≤0.1%+30mA
Readback stability- 30min (%of Output +Offset)	Voltage	≤0.03%+100mV
	Current	≤0.1%+30mA
Readback stability-8h (%of Output +Offset)	Voltage	≤0.03%+100mV
	Current	≤0.1%+30mA
Efficiency	91.5%(200V/15A) ~ 93.5%(750V/4A)	
Remote Sense Compensation Voltage	5V	
Command Response Time	20mS	
Power Factor	0.99	
Maximum input current ⁸	19A	
Maximum input apparent power	3800VA	

Parameter	IT6526C Version: V1.4
Storage temperature	-10°C ~ 70°C
Protective function	Source OVP, OCP, OPP and Load OCP, OPP, OTP, Vsense reversed
standard Interface	USB/RS232/CAN/GPIB/LAN
Isolation (output to ground)	750V
Parallel Number	≤8
Parallel Number of Power Dissipater	1/2/3
Working temperature	0 ~ 40°C
Dimension (mm)	483mmW×105.4mmH×640.8mmD
Weight(net)	17Kg

5.1.39 IT6536C

Parameter	IT6536C Version: V1.4	
Output Rating (0 °C-40 °C)	Output Voltage	0 ~ 750V
	Output Current	0 ~ 30A
	Internal Sink Current ¹	0 ~ 10A
	External Sink Current ¹	0 ~ 30A
	Output Power	0 ~ 6KW
	Internal Sink Power ¹	0 ~ 300W
	External Sink Power ¹	0 ~ 18KW
Output Resistance	Range	0 ~ 93.75Ω
	Accuracy ²	0.25%+300mΩ
	Resolution	10mΩ
Line regulation ±(% of Output+Offset)	Voltage	≤0.01%+75mV
	Current	≤0.1%+15mA
Load regulation ±(% of Output+Offset)	Voltage	≤0.01%+200mV
	Current	≤0.05%+30mA
Setup Resolution	Voltage	100mV

Parameter		IT6536C Version: V1.4
	Current	10mA
	Power	0.1W
Read Back Resolution	Voltage	100mV
	Current	10mA
	Power	0.1W
Setup Accuracy (within 12 months, 25°C±5°C) ±(% of Output+Offset)	Voltage	≤0.05%+300mV
	Current	≤0.2%+30mA
	Power	≤1%+60W
Read Back Accuracy (within 12 months, 25°C±5°C) ±(% of Output+Offset)	Voltage	≤0.05%+300mV
	Current	≤0.2%+30mA
	Power	≤1%+60W
Ripple (20Hz -20MHz)	Voltage	≤750mVp-p
	Current	≤60mA _{rms}
Setup Temperature Coefficient (% of Output/°C+Offset)	Voltage	≤0.03 %+100mV
	Current	≤0.1%+60mA
Read Back Temperature Coefficient (% of Output/°C+Offset)	Voltage	≤0.03%+100mV
	Current	≤0.1%+60mA
Rise time(no load) ⁵	Voltage	≤50ms
Rise time(full load) ⁵	Voltage	≤80ms
Fall time(no load) ⁵	Voltage	≤250ms
Fall time(full load) ⁵	Voltage	≤20ms
Current seamless switching ⁶	-90% ~ 90%	≤70ms
	90% ~ -90%	≤70ms
Transient Response Time	Voltage	≤3.5ms
AC Input ⁷	Voltage	220V±10%
	Frequency	47Hz ~ 63Hz
Setup stability-30min (% of Output +Offset)	Voltage	≤0.03%+100mV
	Current	≤0.1%+60mA
Setup stability-8h (% of Output +Offset)	Voltage	≤0.03%+100mV
	Current	≤0.1%+60mA
Readback stability- 30min (% of Output +Offset)	Voltage	≤0.03%+100mV
	Current	≤0.1%+60mA

Parameter		IT6536C Version: V1.4
Readback stability-8h (%of Output +Offset)	Voltage	$\leq 0.03\% + 100\text{mV}$
	Current	$\leq 0.1\% + 60\text{mA}$
Efficiency	91.5%(200V/30A) ~ 93.5%(750V/8A)	
Remote Sense Compensation Voltage	5V	
Command Response Time	20mS	
Power Factor	0.99	
Maximum input current ⁸	38A	
Maximum input apparent power	7600VA	
Storage temperature	-10°C ~ 70°C	
Protective function	Source OVP, OCP, OPP and Load OCP, OPP, OTP, Vsense reversed	
standard Interface	USB/RS232/CAN/GPIB/LAN	
Isolation (output to ground)	750V	
Parallel Number	≤ 8	
Parallel Number of Power Dissipater	2/4/6	
Working temperature	0 ~ 40°C	
Dimension (mm)	483mmW×194mmH×640.8mmD	
Weight(net)	35Kg	

5.1.40 IT6546C

Parameter		IT6546C Version: V1.4
Output Rating (0 °C-40 °C)	Output Voltage	0 ~ 750V
	Output Current	0 ~ 45A
	Internal Sink Current ¹	0 ~ 15A
	External Sink Current ¹	0 ~ 45A
	Output Power	0 ~ 9KW
	Internal Sink Power ¹	0 ~ 450W

Parameter		IT6546C Version: V1.4
	External Sink Power ¹	0 ~ 27KW
Output Resistance	Range	0 ~ 62.5Ω
	Accuracy ²	0.25%+300mΩ
	Resolution	10mΩ
Line regulation ±(% of Output+Offset)	Voltage	≤0.01%+75mV
	Current	≤0.1%+22.5mA
Load regulation ±(% of Output+Offset)	Voltage	≤0.01%+200mV
	Current	≤0.05%+45mA
Setup Resolution	Voltage	100mV
	Current	10mA
	Power	0.1W
Read Back Resolution	Voltage	100mV
	Current	10mA
	Power	0.1W
Setup Accuracy (within 12 months, 25°C ±5°C) ±(% of Output+Offset)	Voltage	≤0.05%+300mV
	Current	≤0.2%+45mA
	Power	≤1%+90W
Read Back Accuracy (within 12 months, 25°C ±5°C) ±(% of Output+Offset)	Voltage	≤0.05%+300mV
	Current	≤0.2%+45mA
	Power	≤1%+90W
Ripple (20Hz -20MHz)	Voltage	≤750mVp-p
	Current	≤90mA _{rms}
Setup Temperature Coefficient (% of Output/°C+Offset)	Voltage	≤0.03 %+100mV
	Current	≤0.1%+90mA
Read Back Temperature Coefficient (% of Output/°C+Offset)	Voltage	≤0.03%+100mV
	Current	≤0.1%+90mA
Rise time(no load) ⁵	Voltage	≤50ms
Rise time(full load) ⁵	Voltage	≤80ms
Fall time(no load) ⁵	Voltage	≤250ms
Fall time(full load) ⁵	Voltage	≤20ms
Current seamless switching ⁶	-90% ~ 90%	≤105ms
	90% ~ -90%	≤105ms

Parameter		IT6546C Version: V1.4
Transient Response Time	Voltage	≤3.5ms
AC Input ⁷	Voltage	220V±10%
	Frequency	47Hz ~ 63Hz
Setup stability-30min (%of Output +Offset)	Voltage	≤0.03%+100mV
	Current	≤0.1%+90mA
Setup stability-8h (%of Output +Offset)	Voltage	≤0.03%+100mV
	Current	≤0.1%+90mA
Readback stability-30min (%of Output +Offset)	Voltage	≤0.03%+100mV
	Current	≤0.1%+90mA
Readback stability-8h (%of Output +Offset)	Voltage	≤0.03%+100mV
	Current	≤0.1%+90mA
Efficiency	91.5%(200V/45A) ~ 93.5%(750V/12A)	
Remote Sense Compensation Voltage	5V	
Command Response Time	20mS	
Power Factor	0.99	
Maximum input current ⁸	19A	
Maximum input apparent power	11400VA	
Storage temperature	-10°C ~ 70°C	
Protective function	Source OVP, OCP, OPP and Load OCP, OPP, OTP, Vsense reversed	
standard Interface	USB/RS232/CAN/GPIB/LAN	
Isolation (output to ground)	750V	
Parallel Number	≤8	
Parallel Number of Power Dissipater	3/6/9	
Working temperature	0 ~ 40°C	
Dimension (mm)	483mmW×283.2mmH×640.8mmD	
Weight(net)	53Kg	

5.1.41 IT6556C

Parameter		IT6556C Version: V1.4
Output Rating (0 °C-40 °C)	Output Voltage	0 ~ 750V
	Output Current	0 ~ 60A
	Internal Sink Current ¹	0 ~ 20A
	External Sink Current ¹	0 ~ 60A
	Output Power	0 ~ 12KW
	Internal Sink Power ¹	0 ~ 600W
	External Sink Power ¹	0 ~ 36KW
Output Resistance	Range	0 ~ 46.87Ω
	Accuracy ²	0.25%+300mΩ
	Resolution	10mΩ
Line regulation ±(% of Output+Offset)	Voltage	≤0.01%+75mV
	Current	≤0.1%+30mA
Load regulation ±(% of Output+Offset)	Voltage	≤0.01%+200mV
	Current	≤0.05%+60mA
Setup Resolution	Voltage	100mV
	Current	10mA
	Power	0.1W
Read Back Resolution	Voltage	100mV
	Current	10mA
	Power	0.1W
Setup Accuracy (within 12 months, 25°C±5°C) ±(% of Output+Offset)	Voltage	≤0.05%+300mV
	Current	≤0.2%+60mA
	Power	≤1%+120W
Read Back Accuracy (within 12 months, 25°C±5°C) ±(% of Output+Offset)	Voltage	≤0.05%+300mV
	Current	≤0.2%+60mA
	Power	≤1%+120W
Ripple (20Hz -20MHz)	Voltage	≤750mVp-p
	Current	≤120mArms
Setup Temperature Coefficient	Voltage	≤0.03 %+100mV

Parameter		IT6556C Version: V1.4
(% of Output/°C+Offset)	Current	≤0.1%+120mA
Read Back Temperature Coefficient (% of Output/°C+Offset)	Voltage	≤0.03%+100mV
	Current	≤0.1%+120mA
Rise time(no load) ⁵	Voltage	≤50ms
Rise time(full load) ⁵	Voltage	≤80ms
Fall time(no load) ⁵	Voltage	≤250ms
Fall time(full load) ⁵	Voltage	≤20ms
Current seamless switching ⁶	-90% ~ 90%	≤140ms
	90% ~ -90%	≤140ms
Transient Response Time	Voltage	≤3.5ms
AC Input ⁷	Voltage	380Vac±10%(Three-phase five wire)
	Frequency	47Hz ~ 63Hz
Setup stability-30min (% of Output +Offset)	Voltage	≤0.03%+100mV
	Current	≤0.1%+120mA
Setup stability-8h (% of Output +Offset)	Voltage	≤0.03%+100mV
	Current	≤0.1%+120mA
Readback stability-30min (% of Output +Offset)	Voltage	≤0.03%+100mV
	Current	≤0.1%+120mA
Readback stability-8h (% of Output +Offset)	Voltage	≤0.03%+100mV
	Current	≤0.1%+120mA
Efficiency	91.5%(200V/60A) ~ 93.5%(750V/16A)	
Remote Sense Compensation Voltage	5V	
Command Response Time	20mS	
Power Factor	0.99	
Maximum input current ⁸	38A	
Maximum input apparent power	15200VA	
Storage temperature	-10°C ~ 70°C	
Protective function	Source OVP, OCP, OPP and Load OCP, OPP, OTP, Vsense reversed	
standard Interface	USB/RS232/CAN/GPIB/LAN	

Parameter	IT6556C Version: V1.4
Isolation (output to ground)	750V
Parallel Number	≤8
Parallel Number of Power Dissipater	4/8/12
Working temperature	0 ~ 40°C
Dimension (mm)	554mmW×902mmH×807.5mmD (ITECH 15UCabinet)
Weight(net)	119Kg

5.1.42 IT6566C

Parameter	IT6566C Version: V1.4	
Output Rating (0 °C-40 °C)	Output Voltage	0 ~ 750V
	Output Current	0 ~ 75A
	Internal Sink Current ¹	0 ~ 25A
	External Sink Current ¹	0 ~ 75A
	Output Power	0 ~ 15KW
	Internal Sink Power ¹	0 ~ 750W
	External Sink Power ¹	0 ~ 45KW
Output Resistance	Range	0 ~ 37.5Ω
	Accuracy ²	0.25%+300mΩ
	Resolution	10mΩ
Line regulation ±(% of Output+Offset)	Voltage	≤0.01%+75mV
	Current	≤0.1%+37.5mA
Load regulation ±(% of Output+Offset)	Voltage	≤0.01%+200mV
	Current	≤0.05%+75mA
Setup Resolution	Voltage	100mV
	Current	10mA
	Power	0.1W
Read Back Resolution	Voltage	100mV
	Current	10mA
	Power	0.1W

Parameter		IT6566C Version: V1.4
Setup Accuracy (within 12 months, 25°C ±5°C) ±(% of Output+Offset)	Voltage	≤0.05%+300mV
	Current	≤0.2%+75mA
	Power	≤1%+150W
Read Back Accuracy (within 12 months, 25°C ±5°C) ±(% of Output+Offset)	Voltage	≤0.05%+300mV
	Current	≤0.2%+75mA
	Power	≤1%+150W
Ripple (20Hz -20MHz)	Voltage	≤750mVp-p
	Current	≤150mA _{rms}
Setup Temperature Coefficient (% of Output/°C+Offset)	Voltage	≤0.03 %+100mV
	Current	≤0.1%+150mA
Read Back Temperature Coefficient (% of Output/°C+Offset)	Voltage	≤0.03%+100mV
	Current	≤0.1%+150mA
Rise time(no load) ⁵	Voltage	≤50ms
Rise time(full load) ⁵	Voltage	≤80ms
Fall time(no load) ⁵	Voltage	≤250ms
Fall time(full load) ⁵	Voltage	≤20ms
Current seamless switching ⁶	-90% ~ 90%	≤175ms
	90% ~ -90%	≤175ms
Transient Response Time	Voltage	≤3.5ms
AC Input ⁷	Voltage	380Vac±10%(Three-phase five wire)
	Frequency	47Hz ~ 63Hz
Setup stability-30min (% of Output +Offset)	Voltage	≤0.03%+100mV
	Current	≤0.1%+150mA
Setup stability-8h (% of Output +Offset)	Voltage	≤0.03%+100mV
	Current	≤0.1%+150mA
Readback stability-30min (% of Output +Offset)	Voltage	≤0.03%+100mV
	Current	≤0.1%+150mA
Readback stability-8h (% of Output +Offset)	Voltage	≤0.03%+100mV
	Current	≤0.1%+150mA
Efficiency	91.5%(200V/75A) ~ 93.5%(750V/20A)	
Remote Sense Compensation Voltage	5V	

Parameter		IT6566C Version: V1.4
Command Response Time		20mS
Power Factor		0.99
Maximum input current ⁸		38A
Maximum input apparent power		19000VA
Storage temperature		-10°C ~ 70°C
Protective function		Source OVP, OCP, OPP and Load OCP, OPP, OTP, Vsense reversed
standard Interface		USB/RS232/CAN/GPIB/LAN
Isolation (output to ground)		750V
Parallel Number		≤8
Parallel Number of Power Dissipater		5/10/15
Working temperature		0 ~ 40°C
Dimension (mm)		554mmW×902mmH×807.5mmD (ITECH 15UCabinet)
Weight(net)		137Kg

5.1.43 IT6576C

Parameter		IT6576C Version: V1.4
Output Rating (0 °C-40 °C)	Output Voltage	0 ~ 750V
	Output Current	0 ~ 105A
	Internal Sink Current ¹	0 ~ 35A
	External Sink Current ¹	0 ~ 105A
	Output Power	0 ~ 21KW
	Internal Sink Power ¹	0 ~ 1050W
	External Sink Power ¹	0 ~ 63KW
Output Resistance	Range	0 ~ 26.8Ω
	Accuracy ²	0.25%+300mΩ
	Resolution	10mΩ
Line regulation	Voltage	≤0.01%+75mV

Parameter		IT6576C Version: V1.4
±(% of Output+Offset)	Current	≤0.1%+52.5mA
Load regulation	Voltage	≤0.01%+200mV
±(% of Output+Offset)	Current	≤0.05%+105mA
Setup Resolution	Voltage	100mV
	Current	10mA
	Power	0.1W
Read Back Resolution	Voltage	100mV
	Current	10mA
	Power	0.1W
Setup Accuracy (within 12 months, 25°C ±5°C) ±(% of Output+Offset)	Voltage	≤0.05%+300mV
	Current	≤0.2%+105mA
	Power	≤1%+210W
Read Back Accuracy (within 12 months, 25°C ±5°C) ±(% of Output+Offset)	Voltage	≤0.05%+300mV
	Current	≤0.2%+105mA
	Power	≤1%+210W
Ripple (20Hz -20MHz)	Voltage	≤750mVp-p
	Current	≤210mA _{rms}
Setup Temperature Coefficient (% of Output/°C+Offset)	Voltage	≤0.03 %+100mV
	Current	≤0.1%+210mA
Read Back Temperature Coefficient (% of Output/°C+Offset)	Voltage	≤0.03%+100mV
	Current	≤0.1%+210mA
Rise time(no load) ⁵	Voltage	≤50ms
Rise time(full load) ⁵	Voltage	≤80ms
Fall time(no load) ⁵	Voltage	≤250ms
Fall time(full load) ⁵	Voltage	≤20ms
Current seamless switching ⁶	-90% ~ 90%	≤245ms
	90% ~ -90%	≤245ms
Transient Response Time	Voltage	≤3.5ms
AC Input ⁷	Voltage	380V±10%(Three-phase five wire)
	Frequency	47Hz ~ 63Hz
Setup stability-30min (% of Output +Offset)	Voltage	≤0.03%+100mV
	Current	≤0.1%+210mA

Parameter		IT6576C Version: V1.4
Setup stability-8h (%of Output +Offset)	Voltage	$\leq 0.03\% + 100\text{mV}$
	Current	$\leq 0.1\% + 210\text{mA}$
Readback stability-30min (%of Output +Offset)	Voltage	$\leq 0.03\% + 100\text{mV}$
	Current	$\leq 0.1\% + 210\text{mA}$
Readback stability-8h (%of Output +Offset)	Voltage	$\leq 0.03\% + 100\text{mV}$
	Current	$\leq 0.1\% + 210\text{mA}$
Efficiency	91.5%(200V/105A) ~ 93.5%(750V/28A)	
Remote Sense Compensation Voltage	5V	
Command Response Time	20mS	
Power Factor	0.99	
Maximum input current ⁸	57A	
Maximum input apparent power	26600VA	
Storage temperature	-10°C ~ 70°C	
Protective function	Source OVP, OCP, OPP and Load OCP, OPP, OTP, Vsense reversed	
standard Interface	USB/RS232/CAN/GPIB/LAN	
Isolation (output to ground)	750V	
Parallel Number	≤ 8	
Parallel Number of Power Dissipater	7/14/21	
Working temperature	0 ~ 40°C	
Dimension (mm)	550mmW×1289.3mmH×834.8mmD(ITECH 24UCabinet)	
Weight(net)	230Kg	

5.1.44 IT6586C

Parameter		IT6586C 版本 : V1.3
Output Rating (0 °C-40 °C)	Output Voltage	0 ~ 750V
	Output Current	0 ~ 120A
	Internal Sink Current ¹	0 ~ 40A

Parameter		IT6586C 版本 : V1.3
	External Sink Current ¹	0 ~ 120A
	Output Power	0 ~ 24KW
	Internal Sink Power ¹	0 ~ 1200W
	External Sink Power ¹	0 ~ 72KW
Output Resistance	Range	0 ~ 23.4Ω
	Accuracy ²	0.25%+300mΩ
	Resolution	10mΩ
Line regulation ±(% of Output+Offset)	Voltage	≤0.01%+75mV
	Current	≤0.1%+60mA
Load regulation ±(% of Output+Offset)	Voltage	≤0.01%+200mV
	Current	≤0.05%+120mA
Setup Resolution	Voltage	100mV
	Current	10mA
	Power	0.1W
Read Back Resolution	Voltage	100mV
	Current	10mA
	Power	0.1W
Setup Accuracy (within 12 months, 25°C ±5°C) ±(% of Output+Offset)	Voltage	≤0.05%+300mV
	Current	≤0.2%+120mA
	Power	≤1%+240W
Read Back Accuracy (within 12 months, 25°C ±5°C) ±(% of Output+Offset)	Voltage	≤0.05%+300mV
	Current	≤0.2%+120mA
	Power	≤1%+240W
Ripple (20Hz -20MHz)	Voltage	≤750mVp-p
	Current	≤240mArms
Setup Temperature Coefficient (% of Output/°C+Offset)	Voltage	≤0.03 %+100mV
	Current	≤0.1%+240mA
Read Back Temperature Coefficient (% of Output/°C+Offset)	Voltage	≤0.03%+100mV
	Current	≤0.1%+240mA
Rise time(no load) ⁵	Voltage	≤50ms
Rise time(full load) ⁵	Voltage	≤80ms

Parameter		IT6586C 版本 : V1.3
Fall time(no load) ⁵	Voltage	≤250ms
Fall time(full load) ⁵	Voltage	≤20ms
Current seamless switching ⁶	-90% ~ 90%	≤280ms
	90% ~ -90%	≤280ms
Transient Response Time	Voltage	≤3.5ms
AC Input ⁷	Voltage	380V±10%(Three-phase five wire)
	Frequency	47Hz ~ 63Hz
Setup stability-30min (%of Output +Offset)	Voltage	≤0.03%+100mV
	Current	≤0.1%+240mA
Setup stability-8h (%of Output +Offset)	Voltage	≤0.03%+100mV
	Current	≤0.1%+240mA
Readback stability-30min (%of Output +Offset)	Voltage	≤0.03%+100mV
	Current	≤0.1%+240mA
Readback stability-8h (%of Output +Offset)	Voltage	≤0.03%+100mV
	Current	≤0.1%+240mA
Efficiency	91.5%(200V/120A) ~ 93.5%(750V/32A)	
Remote Sense Compensation Voltage	5V	
Command Response Time	20mS	
Power Factor	0.99	
Maximum input current ⁸	57A	
Maximum input apparent power	30400VA	
Storage temperature	-10°C ~ 70°C	
Protective function	Source OVP, OCP, OPP and Load OCP, OPP, OTP, Vsense reversed	
standard Interface	USB/RS232/CAN/GPIB/LAN	
Isolation (output to ground)	750V	
Parallel Number	≤8	
Parallel Number of Power Dissipater	8/16/24	
Working temperature	0 ~ 40°C	

Parameter		IT6586C 版本 : V1.3
Dimension (mm)	550mmW×1289.3mmH×834.8mmD	
Weight(net)	248Kg	

5.1.45 IT6596C

Parameter		IT6596C Version: V1.4
Output Rating (0 °C-40 °C)	Output Voltage	0 ~ 750V
	Output Current	0 ~ 150A
	Internal Sink Current ¹	0 ~ 50A
	External Sink Current ¹	0 ~ 150A
	Output Power	0 ~ 30KW
	Internal Sink Power ¹	0 ~ 1500W
	External Sink Power ¹	0 ~ 90KW
Output Resistance	Range	0 ~ 18.75Ω
	Accuracy ²	0.25%+300mΩ
	Resolution	10mΩ
Line regulation ±(% of Output+Offset)	Voltage	≤0.01%+75mV
	Current	≤0.1%+75mA
Load regulation ±(% of Output+Offset)	Voltage	≤0.01%+200mV
	Current	≤0.05%+150mA
Setup Resolution	Voltage	100mV
	Current	10mA
	Power	0.1W
Read Back Resolution	Voltage	100mV
	Current	10mA
	Power	0.1W
Setup Accuracy (within 12 months, 25°C ±5°C) ±(% of Output+Offset)	Voltage	≤0.05%+300mV
	Current	≤0.2%+150mA
	Power	≤1%+300W
Read Back Accuracy	Voltage	≤0.05%+300mV

Parameter		IT6596C Version: V1.4
(within 12 months, 25°C ±5°C) ±(% of Output+Offset)	Current	≤0.2%+150mA
	Power	≤1%+300W
Ripple (20Hz -20MHz)	Voltage	≤750mVp-p
	Current	≤300mArms
Setup Temperature Coefficient (% of Output/°C+Offset)	Voltage	≤0.03 %+100mV
	Current	≤0.1%+300mA
Read Back Temperature Coefficient (% of Output/°C+Offset)	Voltage	≤0.03%+100mV
	Current	≤0.1%+300mA
Rise time(no load) ⁵	Voltage	≤50ms
Rise time(full load) ⁵	Voltage	≤80ms
Fall time(no load) ⁵	Voltage	≤250ms
Fall time(full load) ⁵	Voltage	≤20ms
Current seamless switching ⁶	-90% ~ 90%	≤350ms
	90% ~ -90%	≤350ms
Transient Response Time	Voltage	≤3.5ms
AC Input ⁷	Voltage	380V±10%(Three-phase five wire)
	Frequency	47Hz ~ 63Hz
Setup stability-30min (% of Output +Offset)	Voltage	≤0.03%+100mV
	Current	≤0.1%+300mA
Setup stability-8h (% of Output +Offset)	Voltage	≤0.03%+100mV
	Current	≤0.1%+300mA
Readback stability-30min (% of Output +Offset)	Voltage	≤0.03%+100mV
	Current	≤0.1%+300mA
Readback stability-8h (% of Output +Offset)	Voltage	≤0.03%+100mV
	Current	≤0.1%+300mA
Efficiency	91.5%(200V/150A) ~ 93.5%(750V/40A)	
Remote Sense Compensation Voltage	5V	
Command Response Time	20mS	
Power Factor	0.99	
Maximum input current ⁸	76A	

Parameter		IT6596C Version: V1.4
Maximum input apparent power		38000VA
Storage temperature		-10°C ~ 70°C
Protective function		Source OVP, OCP, OPP and Load OCP, OPP, OTP, Vsense reversed
standard Interface		USB/RS232/CAN/GPIB/LAN
Isolation (output to ground)		750V
Parallel Number		≤8
Parallel Number of Power Dissipater		10/20/30
Working temperature		0 ~ 40°C
Dimension (mm)		550mmW×1289.3mmH×834.8mmD
Weight(net)		284Kg

5.1.46 IT6517C

Parameter		IT6517C Version: V1.4
Output Rating (0 °C-40 °C)	Output Voltage	0 ~ 1000V
	Output Current	0 ~ 10A
	Internal Sink Current ¹	0 ~ 4.2A
	External Sink Current ¹	0 ~ 10A
	Output Power	0 ~ 1800W
	Internal Sink Power ¹	0 ~ 150W
	External Sink Power ¹	0 ~ 5.4KW
Output Resistance	Range	0 ~ 555.555Ω
	Accuracy ²	0.25% + 375mΩ*A
	Resolution	10mΩ
Line regulation ±(% of Output+Offset)	Voltage	≤0.01%+100mV
	Current	≤0.01%+5mA
Load regulation ±(% of Output+Offset)	Voltage	≤0.01%+375mV
	Current	≤0.05%+10mA

Parameter		IT6517C Version: V1.4
Setup Resolution	Voltage	100mV
	Current	1mA
	Power	0.1W
Read Back Resolution	Voltage	100mV
	Current	1mA
	Power	0.1W
Setup Accuracy ³ (within 12 months, 25°C ±5°C) ±(% of Output+Offset)	Voltage	≤0.05%+375mV
	Current	≤0.2%+10mA
	Power	1%+30W
Read Back Accuracy ⁴ (within 12 months, 25°C ±5°C) ±(% of Output+Offset)	Voltage	≤0.05%+375mV
	Current	≤0.2%+10mA
	Power	1%+30W
Ripple (20Hz -20MHz)	Voltage	≤1.5Vp-p
	Current	≤0.05%+10mA _{rms}
Setup Temperature Coefficient (% of Output/°C+Offset)	Voltage	≤0.01%+375mV
	Current	≤0.02%+10mA
Read Back Temperature Coefficient (% of Output/°C+Offset)	Voltage	≤0.01%+375mV
	Current	≤0.02%+10mA
Rise time(no load) ⁵	Voltage	≤70ms
Rise time(full load) ⁵	Voltage	≤100ms
Fall time(no load) ⁵	Voltage	≤350ms
Fall time(full load) ⁵	Voltage	≤60ms
Current seamless switching ⁶	-90% ~ 90%	≤25ms
	90% ~ -90%	≤25ms
Transient Response Time	Voltage	≤3ms
AC Input ⁷	Voltage	220V±10%
	Frequency	47Hz ~ 63Hz
Setup stability-30min (% of Output +Offset)	Voltage	≤0.05%+375mV
	Current	≤0.1%+10mA
Setup stability-8h (% of Output +Offset)	Voltage	≤0.05%+375mV
	Current	≤0.1%+10mA
Readback stability-30min (% of Output +Offset)	Voltage	≤0.05%+375mV

Parameter		IT6517C Version: V1.4
	Current	$\leq 0.1\% + 10\text{mA}$
Readback stability-8h (%of Output +Offset)	Voltage	$\leq 0.05\% + 375\text{mV}$
	Current	$\leq 0.1\% + 10\text{mA}$
Efficiency		80%
Remote Sense Compensation Voltage		3V
Command Response Time		20mS
Power Factor		0.99
Maximum input current ⁸		12A
Maximum input apparent power		2300VA
Storage temperature		-10°C ~ 70°C
Protective function		Source OVP, OCP, OPP and Load OCP, OPP, OTP, Vsense reversed
standard Interface		USB/RS232/CAN/GPIB/LAN
Isolation (output to ground)		1000V
Parallel Number		≤ 8
Parallel Number of Power Dissipater		1/2/3
Working temperature		0 ~ 40°C
Dimension (mm)		483mmW×105.4mmH×640.8mmD
Weight(net)		17Kg

5.1.47 IT6527C

Parameter		IT6527C 版本 : V1.3
Output Rating (0 °C-40 °C)	Output Voltage	0 ~ 1000V
	Output Current	0 ~ 10A
	Internal Sink Current ¹	0 ~ 4.2A
	External Sink Current ¹	0 ~ 10A
	Output Power	0 ~ 3000W

	Internal Sink Power ¹	0 ~ 150W
	External Sink Power ¹	0 ~ 9000W
Output Resistance	Range	0 ~ 333.333Ω
	Accuracy ²	0.25%+375mΩ*A
	Resolution	10mΩ
Line regulation ±(%of Output+Offset)	Voltage	≤0.01%+100mV
	Current	≤0.01%+5mA
Load regulation ±(%of Output+Offset)	Voltage	≤0.01%+375mV
	Current	≤0.05%+10mA
Setup Resolution	Voltage	100mV
	Current	1mA
	Power	0.1W
Read Back Resolution	Voltage	100mV
	Current	1mA
	Power	0.1W
Setup Accuracy ³ (within 12 months, 25°C±5°C) ±(%of Output+Offset)	Voltage	≤0.05%+375mV
	Current	≤0.2%+10mA
	Power	1%+30W
Read Back Accuracy ⁴ (within 12 months, 25°C±5°C) ±(%of Output+Offset)	Voltage	≤0.05%+375mV
	Current	≤0.2%+10mA
	Power	1%+30W
Ripple (20Hz -20MHz)	Voltage	≤1.5Vp-p
	Current	≤0.05%+10mArms
Setup Temperature Coefficient (%of Output/°C+Offset)	Voltage	≤0.01%+375mV
	Current	≤0.02%+10mA
Read Back Temperature Coefficient (%of Output/°C+Offset)	Voltage	≤0.01%+375mV
	Current	≤0.02%+10mA
Rise time(no load) ⁵	Voltage	≤70ms
Rise time(full load) ⁵	Voltage	≤100ms
Fall time(no load) ⁵	Voltage	≤350ms
Fall time(full load) ⁵	Voltage	≤30ms
Current seamless switching ⁶	-90% ~ 90%	≤25ms

	90% ~ -90%	≤25ms
Transient Response Time	Voltage	≤3ms
AC Input ⁷	Voltage	220V±10%
	Frequency	47Hz ~ 63Hz
Setup stability-30min (%of Output +Offset)	Voltage	≤0.05%+375mV
	Current	≤0.1%+10mA
Setup stability-8h (%of Output +Offset)	Voltage	≤0.05%+375mV
	Current	≤0.1%+10mA
Readback stability-30min (%of Output +Offset)	Voltage	≤0.05%+375mV
	Current	≤0.1%+10mA
Readback stability-8h (%of Output +Offset)	Voltage	≤0.05%+375mV
	Current	≤0.1%+10mA
Efficiency	80%	
Remote Sense Compensation Voltage	3V	
Command Response Time	20mS	
Power Factor	0.99	
Maximum input current ⁸	19A	
Maximum input apparent power	3800VA	
Storage temperature	-10°C ~ 70°C	
Protective function	Source OVP, OCP, OPP and Load OCP, OPP, OTP, Vsense reversed	
standard Interface	USB/RS232/CAN/GPIB/LAN	
Isolation (output to ground)	1000V	
Parallel Number	≤8	
Parallel Number of Power Dissipater	1/2/3	
Working temperature	0 ~ 40°C	
Dimension (mm)	483mmW×105.4mmH×640.8mmD	
Weight(net)	17Kg	

5.1.48 IT6537C

Parameter		IT6537C Version: V1.4
Output Rating (0 °C-40 °C)	Output Voltage	0 ~ 1000V
	Output Current	0 ~ 20A
	Internal Sink Current ¹	0 ~ 8.4A
	External Sink Current ¹	0 ~ 20A
	Output Power	0 ~ 6KW
	Internal Sink Power ¹	0 ~ 300W
	External Sink Power ¹	0 ~ 18KW
Output Resistance	Range	0 ~ 166.666Ω
	Accuracy ²	0.25%+375mΩ*A
	Resolution	10mΩ
Line regulation	Voltage	≤0.01%+100mV
±(% of Output+Offset)	Current	≤0.01%+10mA
Load regulation	Voltage	≤0.01%+375mV
±(% of Output+Offset)	Current	≤0.05%+20mA
Setup Resolution	Voltage	100mV
	Current	1mA
	Power	0.1W
Read Back Resolution	Voltage	100mV
	Current	1mA
	Power	0.1W
Setup Accuracy ³	Voltage	≤0.05%+375mV
(within 12 months, 25°C ±5°C)	Current	≤0.2%+20mA
±(% of Output+Offset)	Power	1%+60W
Read Back Accuracy ⁴	Voltage	≤0.05%+375mV
(within 12 months, 25°C ±5°C)	Current	≤0.2%+20mA
±(% of Output+Offset)	Power	1%+60W
Ripple	Voltage	≤1.5Vp-p
(20Hz -20MHz)	Current	≤0.05%+20mArms

Parameter		IT6537C Version: V1.4
Setup Temperature Coefficient	Voltage	$\leq 0.01\% + 375\text{mV}$
(% of Output/ $^{\circ}\text{C}$ +Offset)	Current	$\leq 0.02\% + 20\text{mA}$
Read Back Temperature Coefficient	Voltage	$\leq 0.01\% + 375\text{mV}$
(% of Output/ $^{\circ}\text{C}$ +Offset)	Current	$\leq 0.02\% + 20\text{mA}$
Rise time(no load) ⁵	Voltage	$\leq 70\text{ms}$
Rise time(full load) ⁵	Voltage	$\leq 100\text{ms}$
Fall time(no load) ⁵	Voltage	$\leq 350\text{ms}$
Fall time(full load) ⁵	Voltage	$\leq 30\text{ms}$
Current seamless switching ⁶	-90% ~ 90%	$\leq 50\text{ms}$
	90% ~ -90%	$\leq 50\text{ms}$
Transient Response Time	Voltage	$\leq 3\text{ms}$
AC Input ⁷	Voltage	$220\text{V} \pm 10\%$
	Frequency	47Hz ~ 63Hz
Setup stability-30min (% of Output +Offset)	Voltage	$\leq 0.05\% + 375\text{mV}$
	Current	$\leq 0.1\% + 20\text{mA}$
Setup stability-8h (% of Output +Offset)	Voltage	$\leq 0.05\% + 375\text{mV}$
	Current	$\leq 0.1\% + 20\text{mA}$
Readback stability-30min (% of Output +Offset)	Voltage	$\leq 0.05\% + 375\text{mV}$
	Current	$\leq 0.1\% + 20\text{mA}$
Readback stability-8h (% of Output +Offset)	Voltage	$\leq 0.05\% + 375\text{mV}$
	Current	$\leq 0.1\% + 20\text{mA}$
Efficiency	80%	
Remote Sense Compensation Voltage	3V	
Command Response Time	20mS	
Power Factor	0.99	
Maximum input current ⁸	38A	
Maximum input apparent power	7600VA	
Storage temperature	$-10^{\circ}\text{C} \sim 70^{\circ}\text{C}$	
Protective function	Source OVP, OCP, OPP and Load OCP, OPP, OTP, Vsense reversed	

Parameter	IT6537C Version: V1.4
standard Interface	USB/RS232/CAN/GPIB/LAN
Isolation (output to ground)	1000V
Parallel Number	≤8
Parallel Number of Power Dissipater	2/4/6
Working temperature	0 ~ 40°C
Dimension (mm)	483mmW×194mmH×640.8mmD
Weight(net)	35Kg

5.1.49 IT6547C

Parameter	IT6547C Version: V1.4	
Output Rating (0 °C-40 °C)	Output Voltage	0 ~ 1000V
	Output Current	0 ~ 30A
	Internal Sink Current ¹	0 ~ 12.6A
	External Sink Current ¹	0 ~ 30A
	Output Power	0 ~ 9KW
	Internal Sink Power ¹	0 ~ 450W
	External Sink Power ¹	0 ~ 27KW
Output Resistance	Range	0 ~ 111.111Ω
	Accuracy ²	0.25% + 375mΩ*A
	Resolution	10mΩ
Line regulation ±(%of Output+Offset)	Voltage	≤0.01%+100mV
	Current	≤0.01%+15mA
Load regulation ±(%of Output+Offset)	Voltage	≤0.01%+375mV
	Current	≤0.05%+30mA
Setup Resolution	Voltage	100mV
	Current	10mA
	Power	0.1W
Read Back Resolution	Voltage	100mV

Parameter		IT6547C Version: V1.4
	Current	10mA
	Power	0.1W
Setup Accuracy ³ (within 12 months, 25°C ±5°C) ±(%of Output+Offset)	Voltage	≤0.05%+375mV
	Current	≤0.2%+30mA
	Power	1%+90W
Read Back Accuracy ⁴ (within 12 months, 25°C ±5°C) ±(%of Output+Offset)	Voltage	≤0.05%+375mV
	Current	≤0.2%+30mA
	Power	1%+90W
Ripple (20Hz -20MHz)	Voltage	≤1.5Vp-p
	Current	≤0.05%+30mArms
Setup Temperature Coefficient (%of Output/°C+Offset)	Voltage	≤0.01%+375mV
	Current	≤0.02%+30mA
Read Back Temperature Coefficient (%of Output/°C+Offset)	Voltage	≤0.01%+375mV
	Current	≤0.02%+30mA
Rise time(no load) ⁵	Voltage	≤70ms
Rise time(full load) ⁵	Voltage	≤100ms
Fall time(no load) ⁵	Voltage	≤350ms
Fall time(full load) ⁵	Voltage	≤30ms
Current seamless switching ⁶	-90% ~ 90%	≤75ms
	90% ~ -90%	≤75ms
Transient Response Time	Voltage	≤3ms
AC Input ⁷	Voltage	220V±10%
	Frequency	47Hz ~ 63Hz
Setup stability-30min (%of Output +Offset)	Voltage	≤0.05%+375mV
	Current	≤0.1%+30mA
Setup stability-8h (%of Output +Offset)	Voltage	≤0.05%+375mV
	Current	≤0.1%+30mA
Readback stability-30min (%of Output +Offset)	Voltage	≤0.05%+375mV
	Current	≤0.1%+30mA
Readback stability-8h (%of Output +Offset)	Voltage	≤0.05%+375mV
	Current	≤0.1%+30mA
Efficiency	80%	

Parameter	IT6547C Version: V1.4
Remote Sense Compensation Voltage	3V
Command Response Time	20mS
Power Factor	0.99
Maximum input current ⁸	19A
Maximum input apparent power	11400VA
Storage temperature	-10°C ~ 70°C
Protective function	Source OVP, OCP, OPP and Load OCP, OPP, OTP, Vsense reversed
standard Interface	USB/RS232/CAN/GPIB/LAN
Isolation (output to ground)	1000V
Parallel Number	≤8
Parallel Number of Power Dissipater	3/6/9
Working temperature	0 ~ 40°C
Dimension (mm)	483mmW×283.2mmH×640.8mmD
Weight(net)	53Kg

5.1.50 IT6557C

Parameter	IT6557C Version: V1.4	
Output Rating (0 °C-40 °C)	Output Voltage	0 ~ 1000V
	Output Current	0 ~ 40A
	Internal Sink Current ¹	0 ~ 16.8A
	External Sink Current ¹	0 ~ 40A
	Output Power	0 ~ 12KW
	Internal Sink Power ¹	0 ~ 600W
	External Sink Power ¹	0 ~ 36KW
Output Resistance	Range	0 ~ 83.333Ω
	Accuracy ²	0.25%+375mΩ*A

Parameter		IT6557C Version: V1.4
	Resolution	10mΩ
Line regulation ±(% of Output+Offset)	Voltage	≤0.01%+100mV
	Current	≤0.01%+20mA
Load regulation ±(% of Output+Offset)	Voltage	≤0.01%+375mV
	Current	≤0.05%+40mA
Setup Resolution	Voltage	100mV
	Current	10mA
	Power	0.1W
Read Back Resolution	Voltage	100mV
	Current	10mA
	Power	0.1W
Setup Accuracy ³ (within 12 months, 25°C ±5°C) ±(% of Output+Offset)	Voltage	≤0.05%+375mV
	Current	≤0.2%+40mA
	Power	1%+120W
Read Back Accuracy ⁴ (within 12 months, 25°C ±5°C) ±(% of Output+Offset)	Voltage	≤0.05%+375mV
	Current	≤0.2%+40mA
	Power	1%+120W
Ripple (20Hz -20MHz)	Voltage	≤1.5Vp-p
	Current	≤0.05%+40mA _{rms}
Setup Temperature Coefficient (% of Output/°C+Offset)	Voltage	≤0.01%+375mV
	Current	≤0.02%+40mA
Read Back Temperature Coefficient (% of Output/°C+Offset)	Voltage	≤0.01%+375mV
	Current	≤0.02%+40mA
Rise time(no load) ⁵	Voltage	≤70ms
Rise time(full load) ⁵	Voltage	≤100ms
Fall time(no load) ⁵	Voltage	≤350ms
Fall time(full load) ⁵	Voltage	≤30ms
Current seamless switching ⁶	-90% ~ 90%	≤100ms
	90% ~ -90%	≤100ms
Transient Response Time	Voltage	≤3ms
AC Input ⁷	Voltage	380Vac±10%(Three-phase five wire)
	Frequency	47Hz-63Hz
Setup stability-30min	Voltage	≤0.05%+375mV

Parameter		IT6557C Version: V1.4
(%of Output +Offset)	Current	$\leq 0.1\% + 40\text{mA}$
Setup stability-8h (%of Output +Offset)	Voltage	$\leq 0.05\% + 375\text{mV}$
	Current	$\leq 0.1\% + 40\text{mA}$
Readback stability-30min (%of Output +Offset)	Voltage	$\leq 0.05\% + 375\text{mV}$
	Current	$\leq 0.1\% + 40\text{mA}$
Readback stability-8h (%of Output +Offset)	Voltage	$\leq 0.05\% + 375\text{mV}$
	Current	$\leq 0.1\% + 40\text{mA}$
Efficiency	80%	
Remote Sense Compensation Voltage	3V	
Command Response Time	20mS	
Power Factor	0.99	
Maximum input current ⁸	38A	
Maximum input apparent power	15200VA	
Storage temperature	$-10^{\circ}\text{C} \sim 70^{\circ}\text{C}$	
Protective function	Source OVP, OCP, OPP and Load OCP, OPP, OTP, Vsense reversed	
standard Interface	USB/RS232/CAN/GPIB/LAN	
Isolation (output to ground)	1000V	
Parallel Number	≤ 8	
Parallel Number of Power Dissipater	4/8/12	
Working temperature	$0 \sim 40^{\circ}\text{C}$	
Dimension (mm)	554mmW×902mmH×807.5mmD (ITECH 15UCabinet)	
Weight(net)	119Kg	

5.1.51 IT6567C

Parameter		IT6567C Version: V1.4
Output Rating (0 °C-40 °C)	Output Voltage	0 ~ 1000V
	Output Current	0 ~ 50A

Parameter		IT6567C Version: V1.4
	Internal Sink Current ¹	0 ~ 21A
	External Sink Current ¹	0 ~ 50A
	Output Power	0 ~ 15KW
	Internal Sink Power ¹	0 ~ 750W
	External Sink Power ¹	0 ~ 45KW
Output Resistance	Range	0 ~ 66.666Ω
	Accuracy ²	0.25%+375mΩ*A
	Resolution	10mΩ
Line regulation ±(% of Output+Offset)	Voltage	≤0.01%+100mV
	Current	≤0.01%+25mA
Load regulation ±(% of Output+Offset)	Voltage	≤0.01%+375mV
	Current	≤0.05%+50mA
Setup Resolution	Voltage	100mV
	Current	10mA
	Power	0.1W
Read Back Resolution	Voltage	100mV
	Current	10mA
	Power	0.1W
Setup Accuracy ³ (within 12 months, 25°C ±5°C) ±(% of Output+Offset)	Voltage	≤0.05%+375mV
	Current	≤0.2%+50mA
	Power	1%+150W
Read Back Accuracy ⁴ (within 12 months, 25°C ±5°C) ±(% of Output+Offset)	Voltage	≤0.05%+375mV
	Current	≤0.2%+50mA
	Power	1%+150W
Ripple (20Hz -20MHz)	Voltage	≤1.5Vp-p
	Current	≤0.05%+50mArms
Setup Temperature Coefficient (% of Output/°C+Offset)	Voltage	≤0.01%+375mV
	Current	≤0.02%+50mA
Read Back Temperature Coefficient (% of Output/°C+Offset)	Voltage	≤0.01%+375mV
	Current	≤0.02%+50mA

Parameter		IT6567C Version: V1.4
Rise time(no load) ⁵	Voltage	≤70ms
Rise time(full load) ⁵	Voltage	≤100ms
Fall time(no load) ⁵	Voltage	≤350ms
Fall time(full load) ⁵	Voltage	≤30ms
Current seamless switching ⁶	-90% ~ 90%	≤125ms
	90% ~ -90%	≤125ms
Transient Response Time	Voltage	≤3ms
AC Input ⁷	Voltage	380Vac±10%(Three-phase five wire)
	Frequency	47Hz ~ 63Hz
Setup stability-30min (%of Output +Offset)	Voltage	≤0.05%+375mV
	Current	≤0.1%+50mA
Setup stability-8h (%of Output +Offset)	Voltage	≤0.05%+375mV
	Current	≤0.1%+50mA
Readback stability-30min (%of Output +Offset)	Voltage	≤0.05%+375mV
	Current	≤0.1%+50mA
Readback stability-8h (%of Output +Offset)	Voltage	≤0.05%+375mV
	Current	≤0.1%+50mA
Efficiency		80%
Remote Sense Compensation Voltage		3V
Command Response Time		20mS
Power Factor		0.99
Maximum input current ⁸		38A
Maximum input apparent power		19000VA
Storage temperature		-10°C ~ 70°C
Protective function	Source OVP, OCP, OPP and Load OCP, OPP, OTP, Vsense reversed	
standard Interface	USB/RS232/CAN/GPIB/LAN	
Isolation (output to ground)		1000V
Parallel Number		≤8
Parallel Number of Power Dissipater		5/10/15

Parameter	IT6567C Version: V1.4
Working temperature	0 ~ 40°C
Dimension (mm)	554mmW×902mmH×807.5mmD (ITECH 15UCabinet)
Weight(net)	137Kg

5.1.52 IT6577C

Parameter	IT6577C Version: V1.4	
Output Rating (0 °C-40 °C)	Output Voltage	0 ~ 1000V
	Output Current	0 ~ 70A
	Internal Sink Current ¹	0 ~ 29.4A
	External Sink Current ¹	0 ~ 70A
	Output Power	0 ~ 21KW
	Internal Sink Power ¹	0 ~ 1050W
	External Sink Power ¹	0 ~ 63KW
Output Resistance	Range	0 ~ 47.622Ω
	Accuracy ²	0.25% + 375mΩ*A
	Resolution	10mΩ
Line regulation ±(%of Output+Offset)	Voltage	≤0.01%+100mV
	Current	≤0.01%+35mA
Load regulation ±(%of Output+Offset)	Voltage	≤0.01%+375mV
	Current	≤0.05%+70mA
Setup Resolution	Voltage	100mV
	Current	10mA
	Power	0.1W
Read Back Resolution	Voltage	100mV
	Current	10mA
	Power	0.1W
Setup Accuracy ³ (within 12 months, 25°C ±5°C) ±(%of Output+Offset)	Voltage	≤0.05%+375mV
	Current	≤0.2%+70mA
	Power	1%+210W

Parameter		IT6577C Version: V1.4
Read Back Accuracy ⁴ (within 12 months, 25°C ±5°C) ±(%of Output+Offset)	Voltage	≤0.05%+375mV
	Current	≤0.2%+70mA
	Power	1%+210W
Ripple (20Hz -20MHz)	Voltage	≤1.5Vp-p
	Current	≤0.05%+70mArms
Setup Temperature Coefficient (%of Output/°C+Offset)	Voltage	≤0.01%+375mV
	Current	≤0.02%+70mA
Read Back Temperature Coefficient (%of Output/°C+Offset)	Voltage	≤0.01%+375mV
	Current	≤0.02%+70mA
Rise time(no load) ⁵	Voltage	≤70ms
Rise time(full load) ⁵	Voltage	≤100ms
Fall time(no load) ⁵	Voltage	≤350ms
Fall time(full load) ⁵	Voltage	≤30ms
Current seamless switching ⁶	-90% ~ 90%	≤175ms
	90% ~ -90%	≤175ms
Transient Response Time	Voltage	≤3ms
AC Input ⁷	Voltage	380Vac±10%(Three-phase five wire)
	Frequency	47Hz ~ 63Hz
Setup stability-30min (%of Output +Offset)	Voltage	≤0.05%+375mV
	Current	≤0.1%+70mA
Setup stability-8h (%of Output +Offset)	Voltage	≤0.05%+375mV
	Current	≤0.1%+70mA
Readback stability-30min (%of Output +Offset)	Voltage	≤0.05%+375mV
	Current	≤0.1%+70mA
Readback stability-8h (%of Output +Offset)	Voltage	≤0.05%+375mV
	Current	≤0.1%+70mA
Efficiency		80%
Remote Sense Compensation Voltage		3V
Command Response Time		20mS
Power Factor		0.99
Maximum input current ⁸		57A

Parameter		IT6577C Version: V1.4
Maximum input apparent power		26600VA
Storage temperature		-10°C ~ 70°C
Protective function		Source OVP, OCP, OPP and Load OCP, OPP, OTP, Vsense reversed
standard Interface		USB/RS232/CAN/GPIB/LAN
Isolation (output to ground)		1000V
Parallel Number		≤8
Parallel Number of Power Dissipater		7/14/21
Working temperature		0 ~ 40°C
Dimension (mm)		550mmW×1289.3mmH×834.8mmD(ITECH 24UCabinet)
Weight(net)		230Kg

5.1.53 IT6587C

Parameter		IT6587C Version: V1.4
Output Rating (0 °C-40 °C)	Output Voltage	0 ~ 1000V
	Output Current	0 ~ 80A
	Internal Sink Current ¹	0 ~ 33.6A
	External Sink Current ¹	0 ~ 80A
	Output Power	0 ~ 24KW
	Internal Sink Power ¹	0 ~ 1200W
	External Sink Power ¹	0 ~ 72KW
Output Resistance	Range	0 ~ 41.666Ω
	Accuracy ²	0.25%+375mΩ*A
	Resolution	10mΩ
Line regulation ±(% of Output+Offset)	Voltage	≤0.01%+100mV
	Current	≤0.01%+40mA
Load regulation ±(% of Output+Offset)	Voltage	≤0.01%+375mV
	Current	≤0.05%+80mA

Parameter		IT6587C Version: V1.4
Setup Resolution	Voltage	100mV
	Current	10mA
	Power	0.1W
Read Back Resolution	Voltage	100mV
	Current	10mA
	Power	0.1W
Setup Accuracy ³ (within 12 months, 25°C ±5°C) ±(% of Output+Offset)	Voltage	≤0.05%+375mV
	Current	≤0.2%+80mA
	Power	1%+240W
Read Back Accuracy ⁴ (within 12 months, 25°C ±5°C) ±(% of Output+Offset)	Voltage	≤0.05%+375mV
	Current	≤0.2%+80mA
	Power	1%+240W
Ripple (20Hz -20MHz)	Voltage	≤1.5Vp-p
	Current	≤0.05%+80mArms
Setup Temperature Coefficient (% of Output/°C+Offset)	Voltage	≤0.01%+375mV
	Current	≤0.02%+80mA
Read Back Temperature Coefficient (% of Output/°C+Offset)	Voltage	≤0.01%+375mV
	Current	≤0.02%+80mA
Rise time(no load) ⁵	Voltage	≤70ms
Rise time(full load) ⁵	Voltage	≤100ms
Fall time(no load) ⁵	Voltage	≤350ms
Fall time(full load) ⁵	Voltage	≤30ms
Current seamless switching ⁶	-90% ~ 90%	≤200ms
	90% ~ -90%	≤200ms
Transient Response Time	Voltage	≤3ms
AC Input ⁷	Voltage	380Vac±10%(Three-phase five wire)
	Frequency	47Hz-63Hz
Setup stability-30min (% of Output +Offset)	Voltage	≤0.05%+375mV
	Current	≤0.1%+80mA
Setup stability-8h (% of Output +Offset)	Voltage	≤0.05%+375mV
	Current	≤0.1%+80mA
Readback stability-30min (% of Output +Offset)	Voltage	≤0.05%+375mV

Parameter		IT6587C Version: V1.4
	Current	$\leq 0.1\% + 80\text{mA}$
Readback stability-8h (%of Output +Offset)	Voltage	$\leq 0.05\% + 375\text{mV}$
	Current	$\leq 0.1\% + 80\text{mA}$
Efficiency		80%
Remote Sense Compensation Voltage		3V
Command Response Time		20mS
Power Factor		0.99
Maximum input current ⁸		57A
Maximum input apparent power		30400VA
Storage temperature		-10°C ~ 70°C
Protective function		Source OVP, OCP, OPP and Load OCP, OPP, OTP, Vsense reversed
standard Interface		USB/RS232/CAN/GPIB/LAN
Isolation (output to ground)		1000V
Parallel Number		≤ 8
Parallel Number of Power Dissipater		8/16/24
Working temperature		0 ~ 40°C
Dimension (mm)		550mmW×1289.3mmH×834.8mmD
Weight(net)		248Kg

5.1.54 IT6597C

Parameter		IT6597C Version: V1.4
Output Rating (0 °C-40 °C)	Output Voltage	0 ~ 1000V
	Output Current	0 ~ 100A
	Internal Sink Current ¹	0 ~ 42A
	External Sink Current ¹	0 ~ 100A
	Output Power	0 ~ 30KW

Parameter		IT6597C Version: V1.4
	Internal Sink Power ¹	0 ~ 1500W
	External Sink Power ¹	0 ~ 90KW
Output Resistance	Range	0 ~ 33.333Ω
	Accuracy ²	0.25%+375mΩ*A
	Resolution	10mΩ
Line regulation ±(% of Output+Offset)	Voltage	≤0.01%+100mV
	Current	≤0.01%+50mA
Load regulation ±(% of Output+Offset)	Voltage	≤0.01%+375mV
	Current	≤0.05%+100mA
Setup Resolution	Voltage	100mV
	Current	10mA
	Power	0.1W
Read Back Resolution	Voltage	100mV
	Current	10mA
	Power	0.1W
Setup Accuracy ³ (within 12 months, 25°C±5°C) ±(% of Output+Offset)	Voltage	≤0.05%+375mV
	Current	≤0.2%+100mA
	Power	1%+300W
Read Back Accuracy ⁴ (within 12 months, 25°C±5°C) ±(% of Output+Offset)	Voltage	≤0.05%+375mV
	Current	≤0.2%+100mA
	Power	1%+300W
Ripple (20Hz -20MHz)	Voltage	≤1.5Vp-p
	Current	≤0.05%+100mArms
Setup Temperature Coefficient (% of Output/°C+Offset)	Voltage	≤0.01%+375mV
	Current	≤0.02%+100mA
Read Back Temperature Coefficient (% of Output/°C+Offset)	Voltage	≤0.01%+375mV
	Current	≤0.02%+100mA
Rise time(no load) ⁵	Voltage	≤70ms
Rise time(full load) ⁵	Voltage	≤100ms
Fall time(no load) ⁵	Voltage	≤350ms
Fall time(full load) ⁵	Voltage	≤30ms

Parameter		IT6597C Version: V1.4
Current seamless switching ⁶	-90% ~ 90%	≤250ms
	90% ~ -90%	≤250ms
Transient Response Time	Voltage	≤3ms
AC Input ⁷	Voltage	380Vac±10%(Three-phase five wire)
	Frequency	47Hz ~ 63Hz
Setup stability-30min (%of Output +Offset)	Voltage	≤0.05%+375mV
	Current	≤0.1%+100mA
Setup stability-8h (%of Output +Offset)	Voltage	≤0.05%+375mV
	Current	≤0.1%+100mA
Readback stability-30min (%of Output +Offset)	Voltage	≤0.05%+375mV
	Current	≤0.1%+100mA
Readback stability-8h (%of Output +Offset)	Voltage	≤0.05%+375mV
	Current	≤0.1%+100mA
Efficiency	80%	
Remote Sense Compensation Voltage	3V	
Command Response Time	20mS	
Power Factor	0.99	
Maximum input current ⁸	76A	
Maximum input apparent power	38000VA	
Storage temperature	-10°C ~ 70°C	
Protective function	Source OVP, OCP, OPP and Load OCP, OPP, OTP, Vsense reversed	
standard Interface	USB/RS232/CAN/GPIB/LAN	
Isolation (output to ground)	1000V	
Parallel Number	≤8	
Parallel Number of Power Dissipater	10/20/30	
Working temperature	0 ~ 40°C	
Dimension (mm)	550mmW×1289.3mmH×834.8mmD	
Weight(net)	284Kg	

The above specifications may be subject to change without prior notice.

1. Internal absorption current and internal absorption power mean the absorption current and power of the standard power dissipater inside the power supply; and external absorption current and external absorption power mean the absorption current and power of the optional power dissipater outside the power supply.

2. Resistance programming accuracy differs based on different output current. For example, 10A Transient 1.0Ω, accuracy: $(1.0\Omega * 0.25\%) + (375m\Omega * A / 10A) = 40m\Omega$.

1.0Ω, accuracy: $(1.0\Omega * 0.25\%) + (375m\Omega * A / 10A) = 40m\Omega$. 3. Set value accuracy means the set accuracy realized through the panel button or communication instructions. When external analog is used for programming, the programming accuracy is 2%FS.

4. Read-back value accuracy means the read-back accuracy realized through panel display or communication instructions; when external analog is used for monitoring, the monitoring accuracy is 1%FS.

5. Up time and down time mean the time of establishment from one value to another value under ON status when the internal standard power dissipater is enabled.

6. Use 12V/120AH battery for test.

7. When used in parallel, to balance power of each phase, distribute the instrument to three phases. But must ensure that single machine input voltage meets Specification requirements.

8. It means the maximum phase current value under minimum work input voltage.

5.2 Supplemental characteristics

State storage capacity: 100 sets

Recommended calibration frequency: once a year

Cooling style: fans

A Appendix

A.1 Specifications of Red and Black Test Cables

ITECH provides you with optional red and black test cables, which are sold individually and you can select for test. For specifications of ITECH test cables and maximum current values, refer to the table below.

Model	Specification	Length	Description
IT-E30110-AB	10A	1m	A pair of red and black test cables with an alligator clip at one end and a banana plug at the other end
IT-E30110-BB	10A	1m	A pair of red and black test cables with banana plugs at both ends
IT-E30110-BY	10A	1m	A pair of red and black test cables with a banana plug at one end and a Y-terminal at the other end
IT-E30312-YY	30A	1.2m	A pair of red and black test cables with Y-terminals at both ends
IT-E30320-YY	30A	2m	A pair of red and black test cables with Y-terminals at both ends
IT-E30615-OO	60A	1.5m	A pair of red and black test cables with round terminals at both ends
IT-E31220-OO	120A	2m	A pair of red and black test cables with round terminals at both ends
IT-E32410-OO	240A	1m	A pair of red and black test cables with round terminals at both ends

Model	Specifica- tion	Length	Description
IT-E32420-OO	240A	2m	A pair of red and black test ca- bles with round terminals at both ends
IT-E33620-OO	360A	2m	A pair of red and black test ca- bles with round terminals at both ends

For maximum current of AWG copper wire, refer to table below.

AWG	10	12	14	16	18	20	22	24	26	28
The Maxi- mum Cur- rent Value (A)	40	25	20	13	10	7	5	3.5	2.5	1.7



Note

AWG (American Wire Gage), it means X wire (marked on the wire). The table above lists current capacity of single wire at working temperature of 30°C. For reference only.

A.2 How to avoid it couldn' t start when test battery

When test battery, the main reason of no start is that battery (residual voltage) discharges capacitors of positive and negative terminals of the power supply.

Method to avoid no start: connect a switch which is parrallel with a current limiting discharging resistor. Close the switch after all the all leads connected well. The wiring diagram as follows:

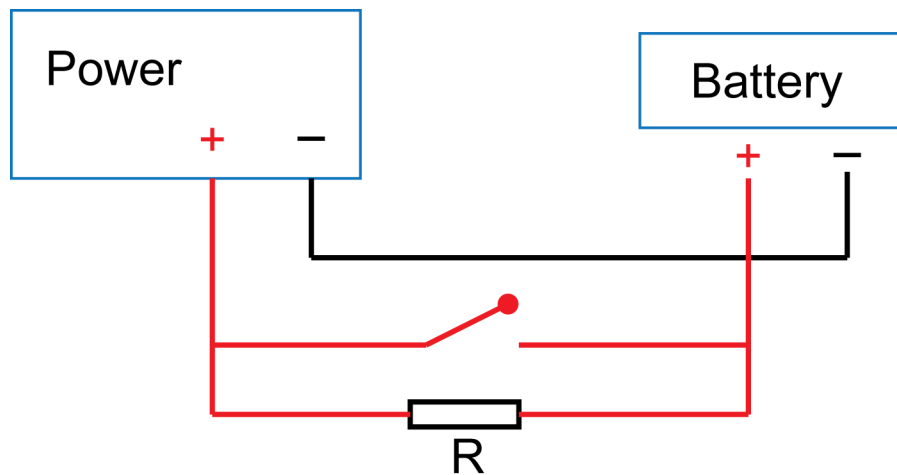



A.3 Fuse Replacement



Different models of our company product are supplied with different fuse assembly. The way to replace the fuse changes accordingly. The common ways are as follows. Please choose the corresponding way of disassembly and replacement based on the fuse assembly of the actual instrument.

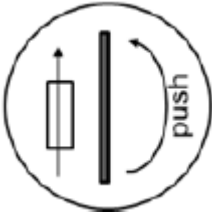
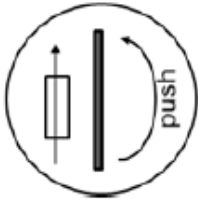
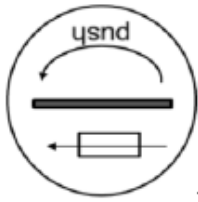
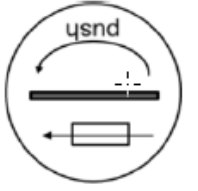
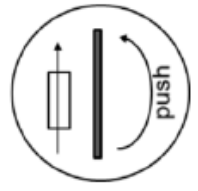

Note

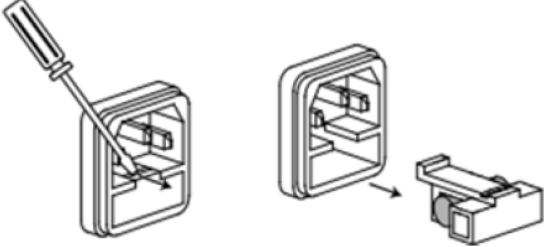
If there are no fuse assembly on the instrument rear panel, it means that you can't replace the fuse by yourself. Please contact the ITECH engineer on the condition of the same malfunction.

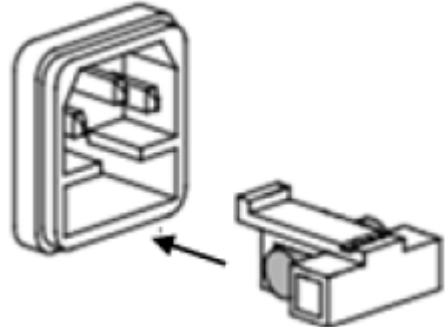
The type of the fuse	The way to replace
	<ol style="list-style-type: none"> 1. Use a screwdriver to push and turn the fuse box anti-clockwise. When turned to 90 degrees, release the screwdriver. Refer to the picture below.   <ol style="list-style-type: none"> 2. The fuse box will bounce up, then you can see the fuse in it. Take out the blown fuse. 3. Please replace with a fuse of the same specification. Refer to the technical specification of the corresponding instrument. 4. When install, put into the fuse box as the picture below. Then use a screwdriver to push and turn the fuse box to 90 degrees clockwise. Refer to the picture below.  
	<p>The power cord jack of the instrument includes the fuse. Please refer to the rear panel introduction of the corresponding instrument for the detailed position. The replacement steps for this type of the fuse are as follows.</p> <ol style="list-style-type: none"> 1. First pull out the power cord, and then take out the fuse block from the power cord jack with a small screwdriver, as shown below.  <ol style="list-style-type: none"> 2. Have a visual inspection of the fuse to see whether it is burnt out; if yes, replace it with another fuse of the same specification. Refer to the corresponding technical specifications for fuse rating.

The type of the fuse	The way to replace
	<p>3. After replacement, mount the fuse block to the original position, as illustrated below.</p> 
	<ol style="list-style-type: none"> 1. Push and turn the fuse box anti-clockwise by hand. When turned to 90 degrees, release the screwdriver. 2. The fuse box will bounce up, then you can see the fuse in it. Take out the blown fuse. 3. Please replace with a fuse of the same specification. Refer to the technical specification of the corresponding instrument. 4. When install, put into the fuse box firstly. Then Push and turn the fuse box to 90 degrees clockwise.

Contact Us

Thanks for purchasing ITECH products. In case of any doubts, please contact us as follows:

1. Refer to accompanying data disk and relevant manual.
2. Visit ITECH website: www.itechate.com.
3. Select the most convenient contact method, for further information.