

Product

ITS5300 Battery cell/ Battery module/Battery pack BOL Test System



ITS5300 Battery cell/ Battery module /Battery pack BOL Test System

APPLICATIONS

- 3C Battery
- Storage Battery
- Military Battery
- Super-capacitor
- EV Battery
- Sightseeing Tourist Car Battery
- Electric Tool Battery

Your Power Testing Solution

ITS5300 Battery cell/ Battery module /Battery Pack BOL Test System



ITS5300 battery charging discharging test system provides turnkey testing solution from Milliampere-grade single cell to Megawatt battery pack. During charging-discharging life cycle test (BOL Test), it can simulate the real working condition, such as driving cycle, current pulse and self-defined waveform, to realize the comprehensive evaluation of battery life time, energy, and endurance mileage. The system is applicable to new products development, quality analysis/incoming inspection, production test and so on. Modular design provides great flexibility and independence for the test system configuration.

To meet the demand of production line testing in large quantities, ITS5300 can simultaneously test the performance of hundreds of independent battery modules/cells, greatly improving the testing efficiency and production of production line. ITS5300 also provides regenerative test solution, and the regenerative efficiency up to 95%, it solves the problem of high electricity cost caused by high power storage battery or large quantity battery module/cell test.

ITS5300 provides comprehensive protection function, not merely hardware itself has over-voltage, over-current, over-temperature, anti-islanding protections, but also the system has optional functions such as emergency stop module, power-off memory function, anti-sparking and reverse connection protection, under voltage protection etc, so as to effectively ensure the reliability of long-time operation of the system.

The ITS5300 battery test system offers a wealth of test steps and powerful statistical analysis capabilities. The channels can be operated synchronously/independently without affecting each other, and support third-party device control (temperature box or water-cooling system). Without any language programming background, users can quickly master the test program editing and running. Powerful statistical analysis function, to assist testers to quickly filter data, efficient completion of battery performance parameters analysis.

FEATURE

- Modular design, Maximum voltage and power up to 2250V/1152kW
- Power regenerative efficiency up to 95%
- Full protection
- High precision measurement, up to 0.02%+0.02%FS
- AC/DC internal resistance test
- Strong scalability, easy to integrate other equipment
- High sampling rate, up to 1ms
- Rich charging and discharging test steps
- Seamless current switching, road conditions simulation
- Data query and statistical analysis functions

Your Power Testing Solution

ITS5300 Battery Cell/ Battery Module/Battery Pack BOL Test System

Battery Pack Test Solutions

ITS5300 battery pack test system can meet not only the basic but also the complicate testing application items, providing solutions for high-power batteries, such as batteries for EV, aerospace, military defense, energy storage, etc. The system is able to simulate the vehicle driving conditions, do cold cranking test and other self-defined waveforms, and etc. For the battery pack test on the vehicle, the system can simulate the standard charging process between the DC pile and the BMS, providing advanced energy-saving bi-directional regenerative solution.

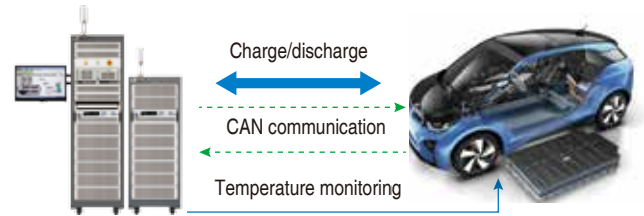

Range of battery pack test

- Voltage: Maximum up to 2250V
- Current: For single unit, up to 2040A
- Measurement accuracy of maximum voltage: $\leq 0.02\% + 0.02\%FS$

* support paralleling for higher current

Features of battery pack test system

- Bidirectional regenerative module of high power density, up to 18kW per single 3U module.
- High energy regenerative efficiency up to 95%.
- Patented parallel technology of fiber paralleling for higher power.
- Seamless switching between sourcing and sinking.
- Simulation of driving condition waveforms of up to 10,000,000 points.
- BMS message receiving and transmitting.

Energy-regenerative testing solutions

ITS5300 battery pack test system can be configured with bidirectional regenerative charging and discharging module, the energy could feed back to grid so as to save electricity during the high-power battery testing. Different from the traditional composition, the energy regenerative solution can convert the battery's energy to clean alternative current electricity which can be used for other power-consuming units in the local grid. The electricity cost could be saved in a big way due to this regenerative system. Besides the bidirectional instruments can also save space for cabinet: the testing channels can be doubled in cabinet integration and this help to improve the testing efficiency.

BMS communication function

ITS5300 battery pack test system provides BMS communication function. The message transmitting and receiving can be communicated between the battery test system and BMS, recording all messages so as for further analyzing. The test system can adjust charging and discharging parameters according to BMS requests, can meet cut off conditions give warning messages based on data collecting from BMS, as well as supports DBC files importing.

- Power: Maximum up to 1152kW
- Ultra-fast sample rate: quickest can be 1ms
- Measurement accuracy of maximum current: $\leq 0.1\% + 0.1\%FS$

- Auxiliary power supply and parameters measurement.
- Supporting integration of equipment from 3rd party, equipment such as incubator, water-cooling system.
- Independent control of each channel while running.
- Simulation of DC charging station to do testing of complete vehicle's battery.
- Simulation of HPPC (Hybrid Pulse Power Characteristic)/Cold Cranking current
- Quick data checking and statistics analyzing functions.

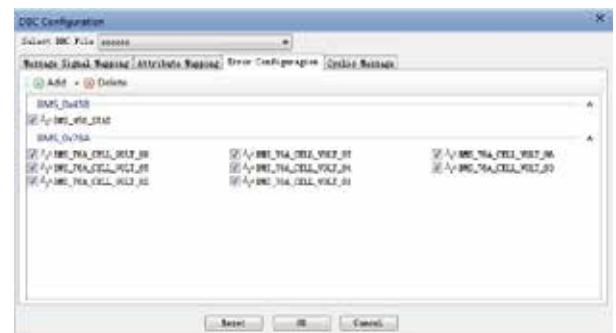
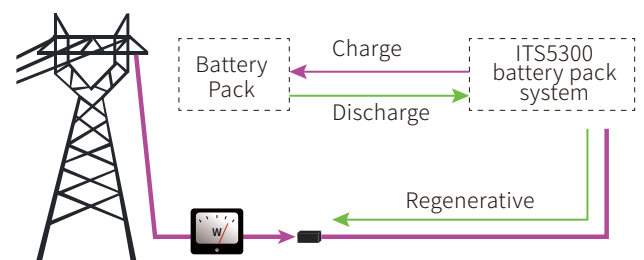

Your Power Testing Solution

ITS5300 Battery Cell/ Battery Module/Battery Pack BOL Test System

Dynamic working conditions simulation

ITS5300 battery pack test system provides complex dynamic working conditions simulation for EV battery application. The software supports .csv file import, and the user may import 10000000 points current waveform data, simulate electric vehicle starting, braking, accelerating, reducing under different road conditions in cities or suburbs from the process of charging from battery power or reverse charging when brakes. The system can also calculate vehicle mileage to reflect the performance of electric vehicles.

Imported waveform points: 10,000,000

Positive and negative current switching time: seamless switching

Current response time (-90% ~ 90%): <2ms

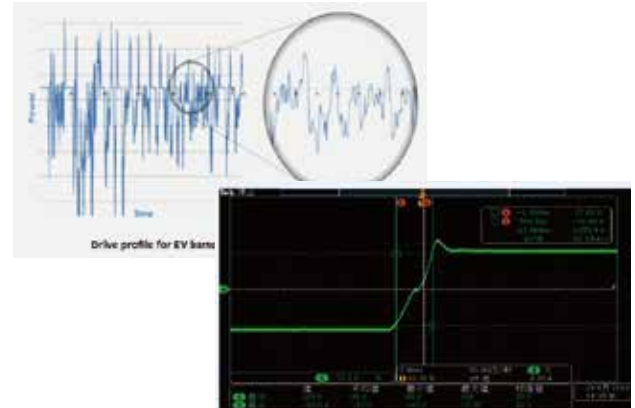

ITS5300 battery pack test system current switching waveform

Parallel between channels to expand power

ITS5300 high-power battery pack test system is with ultra-high power density, the power of a 27U can reach 144kW. Supports master-slave parallel with different power levels at the same voltage units, and can be switched to work with multiple channels. Very flexible for maximum utilization.

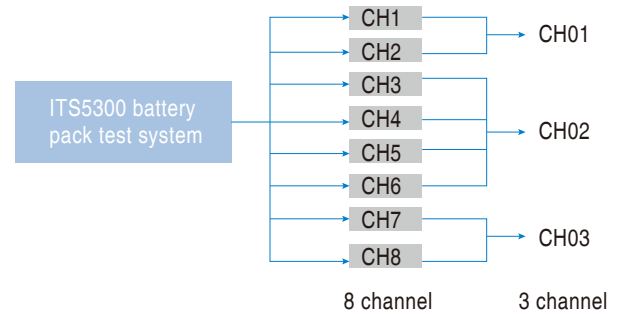

Simulate charging pile

When the power battery pack is placed in the vehicle for testing, the ITS5300 battery pack test system can simulate the DC charging pile to interact with the BMS, and dynamically adjust charging parameters according to the request of the BMS; or when receiving an error message, our system will stop charging in time. The ITS5300 system supports the import of DBC files. All CAN messages will be recorded when tests end.

Integration of other devices

Because the battery characteristics are affected by the ambient temperature, when the temperature is higher, the output energy is larger; otherwise, the output energy is smaller. In the R&D experiment stage, in order to fully verify the temperature characteristics of the battery, place the battery pack in the thermostat cabinet, set the temperature of the thermostat cabinet, and complete the high and low temperature experiments. The ITS5300 battery pack test system can integrate a thermostat or water cooling system according to user needs. The software automatically controls the temperature of the thermostat or starts the water cooling system.

Auxiliary channel measurement function

ITS5300 battery pack test system supports auxiliary measurement function, can monitor the battery pack for additional temperature and voltage with optional temperature logger or multi-channel DVM meter. Temperature logger supports various types of thermocouples, T, K, B, E, J, N, S, R, C, measuring accuracy: $\pm (0.01\% \text{ of reading} + 0.5) \text{ } ^\circ\text{C}$.

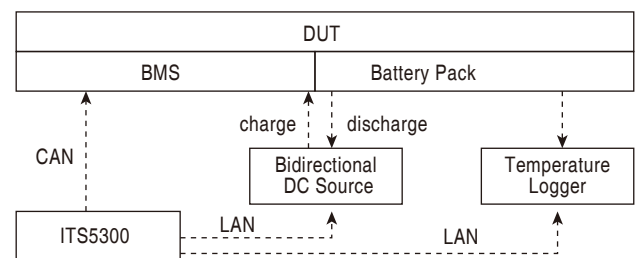

Your Power Testing Solution

ITS5300 Battery Cell/ Battery Module/Battery Pack BOL Test System

Battery Module Test Solution

ITS5300 battery module test system provides users with two solutions, non-regenerative and regenerative, both can synchronously monitor the voltage and temperature of each cell in the module while testing the performance of the module.*1 For smart 3C battery testing, ITS5300 can directly obtain module parameters by supporting communication between SMBus and battery modules. For power battery module testing, ITS5300 provides complex road conditions simulation, cold-start current pulse test and HPPC test, etc. Furthermore, this software provides rich test steps, powerful curve drawing, data query and statistical analysis functions.

*1 Configure with temperature logger and IR tester

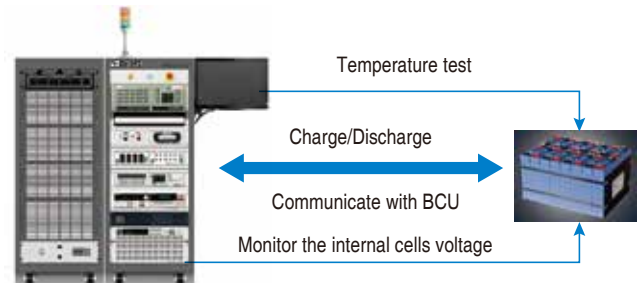

Battery Module Test Range

- Voltage range: 0~1000V
- Max. voltage accuracy: $\leq 0.025\% + 0.025\%FS$
- Ultra-fast sampling rate: 10ms
- Current range: 1200A for stand-alone
- Max. current accuracy: $\leq 0.05\% + 0.1\%FS$

Battery Module System Features

- ACIR and DCIR Test
- HPCE test
- Cycle life test
- Charging and discharging test at different temperatures (room temperature / high temperature / low temperature)
- Charging and discharging test at different rate
- Charge retention test
- BMS communication supporting CANBus or SMBus protocol
- HPPC
- Cell temperature / voltage monitoring function in the module

Cell voltage / temperature monitoring in the battery module

ITS5300 battery module test system provides internal resistance measurement function, combined with temperature logger and internal resistance tester or DVM meter, it can simultaneously monitor the voltage and temperature changes of the unit in the module. And, if the voltage difference exceeds the allowable range, the test will be stopped. ITS5300 temperature logger supports various types of thermocouples, T, K, B, E, J, N, S, R, C, and the accuracy is up to $\pm (0.01\% \text{ of reading} + 0.5) \text{ } ^\circ\text{C}$.

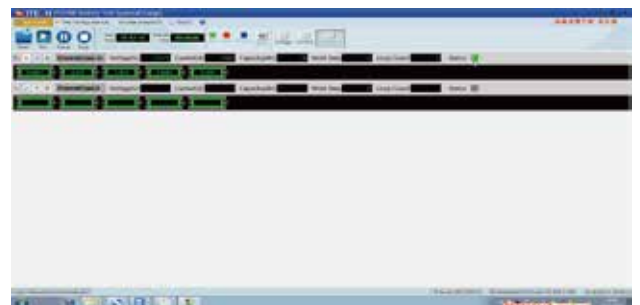

Multi-channel Online Operation / Parallel Extension Power

ITS5300 battery module testing system supports hundreds of channel modules to be tested online at the same time. Channels are independent of each other and can be run simultaneously or controlled separately. The module power between channels can be extended by master and slave parallel, PC only needs to communicate with the host. Different test programs can be executed between channels, which improve the application flexibility of the system.

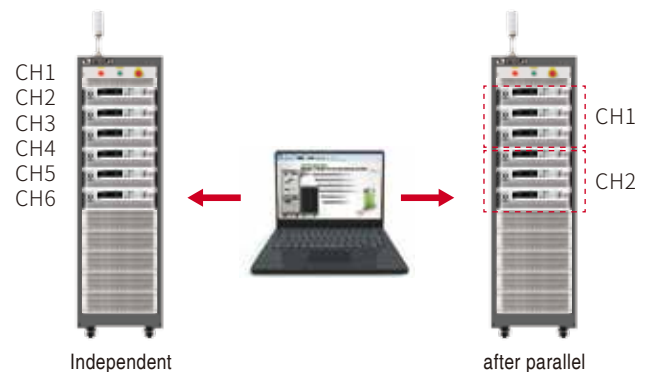

Your Power Testing Solution

ITS5300 Battery Cell/ Battery Module/Battery Pack BOL Test System

Cell Test Solution

Cell test range

- Unit voltage range: 0 ~ 10V
- Single current range: 500mA / 10A / 100A / 200A / 400A / 500A / 600A
- Voltage measurement accuracy: <0.1% FS
- Current measurement accuracy: <0.1% FS

Function and characteristics of single cell system

- Bidirectional energy-feedback test solution
- AC Impedance (ACIR)
- Cycle life test
- Charging and discharging characteristics test at different temperatures (normal temperature / high temperature / low temperature)
- Charge-discharge ability test at different rates
- Self-discharge characteristic test
- Other devices can be integrated: thermostat / water cooling system / DVM meter
- Fast data query and analysis functions

Cell resistance / capacitance test

Battery cell is the smallest unit of the battery. Selecting a battery cell with a better capacity and internal resistance consistency can ensure stable performance and greater output capacity of the battery module or battery pack after series and parallel connection. Therefore, in the test of cell, resistance and capacitance testing becomes particularly important. ITECH ITS5300 cell test system supports the simultaneous testing of hundreds of channels. While improving the test efficiency of the production line, the system can measure the internal resistance and capacity value of each cell. The internal resistance measurement accuracy is up to $\pm 0.5\% \pm 0.05\%$ FS.

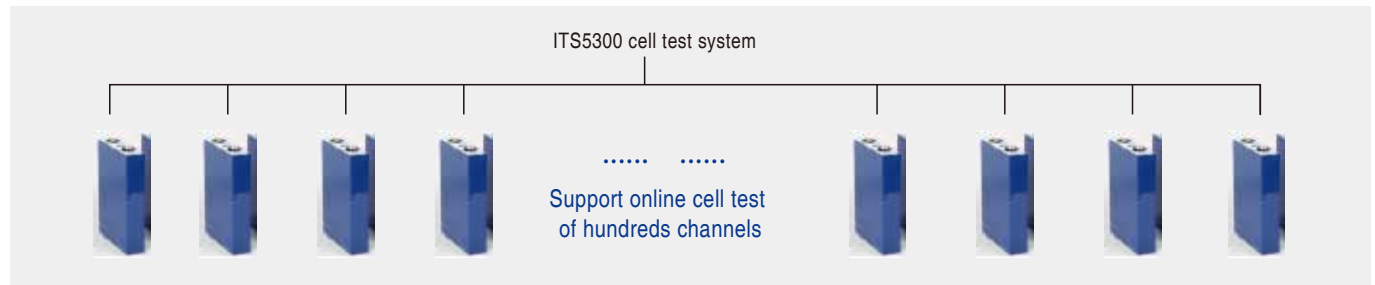

Ultra-high measurement accuracy

Battery capacity is an important indicator of battery characteristics. The traditional battery capacity is implemented by software sampling and integration. Due to the limited communication speed, the sampling rate can only reach 20ms or even longer. ITS5300 battery test system uses the built-in capacity integration function of the hardware module to improve the V / I measurement accuracy and sampling rate, the sample rate is up to 400 kHz. When the current waveform changes, it can still be accurately sampled and integrated in real time to obtain more accurate capacity parameters for the user.

Cell test application range

Suitable for various types of batteries and super capacitor testing.

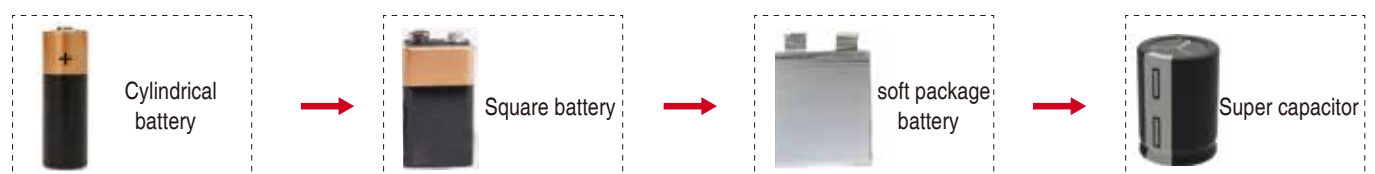

Functions and Advantages

Battery DCIR/ACIR test

The internal resistance of the battery is related to the discharge capacity of the battery. The larger the internal resistance, the smaller the charge and discharge rate of the battery, which will easily cause the battery to generate heat. ITECH provides battery AC internal resistance and DC internal resistance measurement functions. The AC internal resistance is matched with a special AC internal resistance tester to apply a 1KHz excitation signal to both ends of the battery to measure the internal resistance of the battery under static conditions. However, under the real condition, it also includes the polarization internal resistance, the impedance of the connection point, etc. The DC resistance test can more directly reflect the resistance value of the battery in continuous application.

Battery capacity test

Because the battery capacity is affected by the ambient temperature and discharge rate, the capacity test is usually combined with the temperature characteristics and discharge rate. The higher the temperature, the larger the capacity; the larger the discharge rate, the smaller the capacity. ITS5300 system can integrate the control of thermostat, and simulate the environment of normal temperature, high temperature and low temperature. ITS5300 system provides the function of user-defined X-axis and Y-axis parameter categories. You can set the Y-axis as the capacity and the X-axis as the time to obtain the corresponding curve.

discharge characteristics(by rate of discharge)

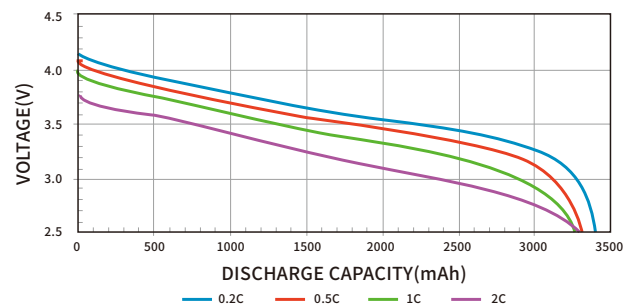

Battery cycle life test

The battery cycle life test is one of the necessary test items for the battery. When the capacity declines to 80% of the original, the life can be considered to end, and the battery life is generally obtained by cyclic charging and discharging. Speaking of the factors affecting battery life, in addition to temperature and frequency of use, dynamic operating conditions will also accelerate battery aging. ITS5300 provides pulse charge and discharge mode and edit steps according to rich charge, rich discharge curve marked in the ISO12405-4-2018 standard.

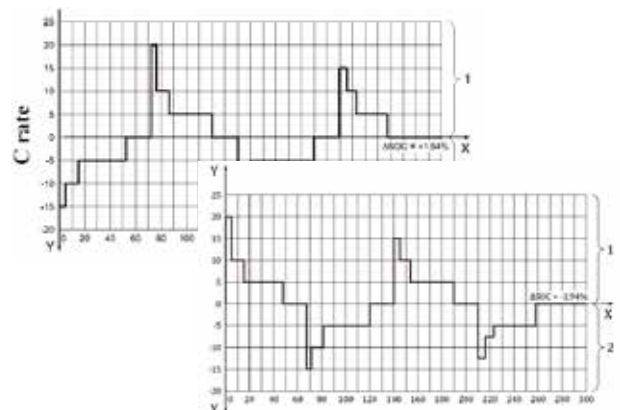

Coulombic efficiency test

Coulombic efficiency describes the efficiency with which charge (electrons) is transferred in a system facilitating an electrochemical reaction. The closer the discharge charge is to the charge, the higher the utilization rate of the battery. If the ratio is small, it indicates that the technical or other aspects of the battery need to be improved. For batteries with good characteristics, high-precision test equipment is necessary for telling the difference between the charged and discharged charges. ITS5300 presents ultra-high sampling rate and measurement accuracy.

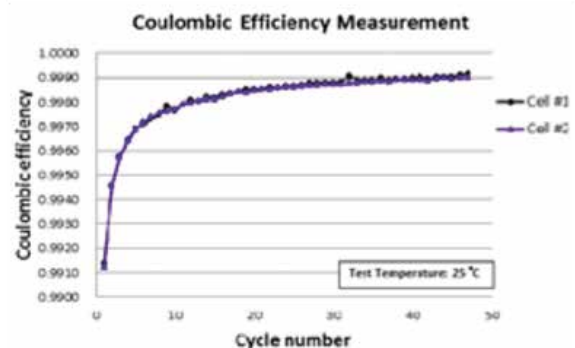

Your Power Testing Solution

ITS5300 Battery Cell/ Battery Module/Battery Pack BOL Test System

HPPC test

The HPPC test is a very important test in FreedomCar. It is used to test the performance of hybrid and pure electric vehicles. It is a common test item when evaluating battery systems / modules or single cells. The main test purpose of HPPC is to establish the relationship between discharge depth and power within the battery voltage range. The second is to use the voltage and current curve to establish a function of the discharge depth, conductive resistance and polarization resistance. Then it can evaluate power degradation during life testing by the resistance measurement results. It is a detection method for fully analyzing power batteries. ITS5300 supports users to edit discharge pulse and feedback pulse value according to HPPC curve.

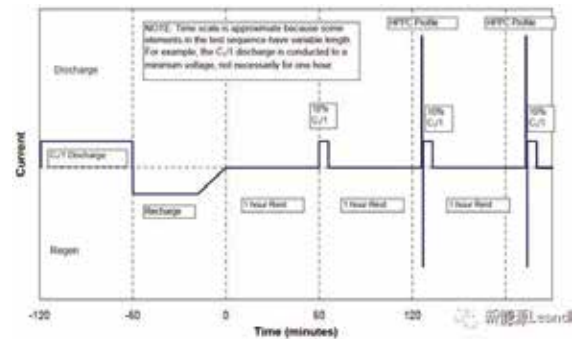

Battery overcharge / over discharge endurance test

For a sealed secondary battery, in the case of overcharging and over discharging, gas will quickly accumulate in the sealed container, and the internal pressure will rise rapidly, which will easily cause the battery to explode. So overcharge and over discharge are important test items to test the safety performance of the battery. Under a certain degree of overcharge, the shape of the battery should not change and catch fire. In order to ensure the safety of the battery, it should be specified of the battery's charging limit voltage, charging upper limit voltage, lower discharging limit voltage, maximum charging current and recommended charging current.

Equilibrium charge and discharge test

The differences in the manufacturing and use processes will cause inconsistencies in the cells inside the battery, which are manifested in terms of cell capacity, internal resistance, and charge and discharge efficiency. In order to avoid the life and capacity loss of the overall battery pack caused by degradation of individual performance, BMS generally has a balanced function. At present, the balancing strategy of each BMS is different. The individual cells can be balanced with each other or an energy-consuming method may also be adopted. A resistor is connected to the back end of each cell to consume the power of the cell with a higher power. ITS5300 can accept the balance start and stop signals of the BMS during the charging and discharging process. Adopting balancing operation of the BMS during the charging and discharging can prevent large differences in battery cells and extend battery life.

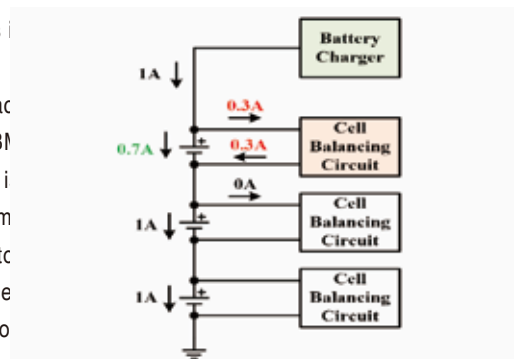

Vehicle power battery pack test

When the power battery pack is placed in the vehicle for testing, the battery charging and discharging system needs to simulate the DC charging pile to interact with the BMS. It can dynamically adjust the charging parameters according to the request of the BMS or stop charging when receiving wrong messages. The ITS5300 system supports the import of DBC files, and after the operation ends, all CAN messages sent and received during the process are recorded.



Dynamic roading conditions simulation test

ITS5300 provides comprehensive dynamic operating simulation functions for EV battery applications. Users can import 10,000,000 points of current waveform data to simulate the process from battery consumption or reverse charging during starting, braking, acceleration and deceleration of an EV under different road conditions in cities or suburbs. The .csv file import is available. ITS5300 software can also help to calculate vehicle mileage for vehicle manufacturers which reflects the performance of electric vehicles more directly.

Protection

Acousto-optic emergency stop

The ITS5300 battery cell / module / battery pack test system provides an acousto-optic emergency stop protection device. When an abnormal situation occurs, the emergency stop button can be used to quickly cut off the output and ensure that the equipment is powered off reliably. The cabinet is equipped with three-color lights, which indicate different operating states through red / yellow / green lights, which is convenient to identify the status of the system from a long distance and provide audible alarm.

Power-off memory protection

Battery performance verification is often a long-term test process. The power-off memory protection module is designed and developed specifically for long-term testing. It can effectively ensure that the long-term test data is protected from abnormal power failures or computer crashes. After the system resumes normal operation, the program continues to execute the next steps, avoiding repeated testing and improving the safety and reliability of the experiment.

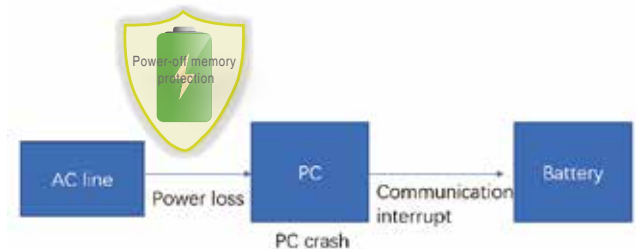

Anti-reverse/anti-spark protection

Anti-reverse anti-spark module is a functional module specially designed to improve safe wiring and reliable power-on. It prevents from the fire phenomenon caused by the suddenly battery charging to internal capacitor of the device during the wiring. And also prevent the battery from being reversely connected to both ends of the device and result in equipment damage.

User rights management function

The ITS5300 test system can set different operation permissions for people in charge of quality, R&D, and production through the user permission setting function. So it can prevent system programs from being arbitrarily modified or artificially stopped abnormally and ensure the reliability and security of the system.

Comprehensive charge and discharge protection

In the battery BOL test, to avoid overcharging and over discharging of the battery, it is necessary to monitor the status of the single cell and the entire battery pack in real time, and when the certain conditions are reached, the circuit is cut off in time to protect the battery. The ITS5300 system provides comprehensive protection, including over and under voltage of each channel and cell, pressure difference of cell, over temperature, over power, etc. Users can customize single or multiple protection settings based on battery specifications.



Anti-islanding protection (regenerative system)

For the energy regenerative battery system solution, the instrument has an anti-islanding protection function to prevent itself from keeping feeding back energy to the grid in the event of a mains power outage, causing unnecessary injury. The energy regenerative system provides pure AC power(harmonics<5%). The feedback energy can be used as power supply for other equipment in the plant, good for saving electricity costs, especially for high power applications where a battery pack or a large number of cells are tested simultaneously.

Your Power Testing Solution

ITS5300 Battery Cell/ Battery Module/Battery Pack BOL Test System

ITS5300 Test System Software Function Introduction

ITS5300 battery test system adopts all-new software structure that allows users to quickly edit test programs without any language programming basics. And, the software provides rich test steps, ultra-fast sampling rates, and powerful report analysis functions, which not only meet various battery test requirements, but also help improve battery process and trace quality problems in the later stages of testing. ITS5300 test system software has strong scalability, and reserves interfaces for integrating third-party devices, such as temperature boxes and water cooling systems.

ITECH System Software Advantages

- No programming basics required, friendly and simple interface
- Rich charge and discharge work steps
- Comprehensive protection functions and cut-off conditions
- Ultra-fast sampling rate: up to 1ms
- Quick copy of test procedures between channels
- Independent or synchronous operation control between channels
- Powerful data query / statistical analysis function
- Fault alarm / fault information recording function
- BMS interaction & message recording function
- User rights management function



Main interface

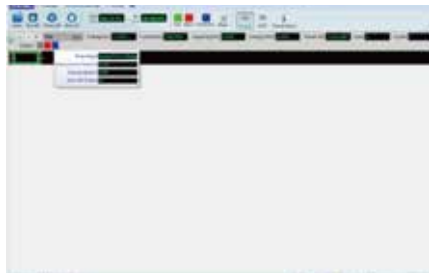

Operation interface



Report interface

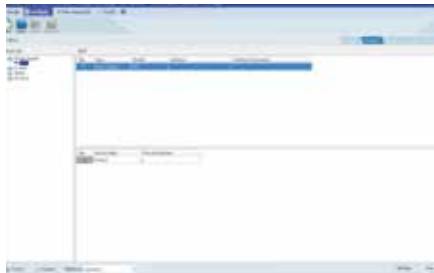

Configuration interface



Real-time display

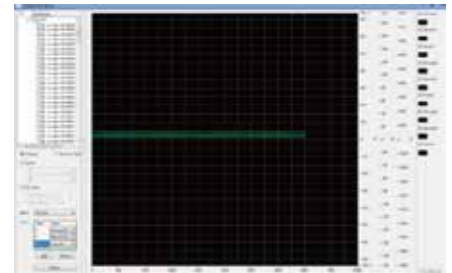

Curve described

Rich Test Work Steps

- Test work steps: CC / CV / CP / CC-CV / CP-CV / CR / Reset / Pulse / DCIR / ACIR / Waveform etc. *
- Cut-off conditions: CAN message / rate of change / expression / Conventional cut-off conditions (cell voltage, cell voltage difference, time, capacity, current, channel voltage)
- Unlimited loop cycle times, unlimited numbers of loop nesting
- Goto
- Reset / stand-by process
- Battery pre-judgment

* Depending on the specific configuration

The testing purpose is to get a comprehensive battery performance analysis

The ITS5300 battery test system provides users with data query and export functions, records battery information within the full test period, such as channel voltage / current / power / capacity / energy, etc., and can also display a certain process step or cell data.

- File export in .csv format
- Curve zoom, recording the whole time period or certain running curve
- Data screening, running time / test steps / cycle times...

Statistical analysis, improve battery performance analysis efficiency

Statistical analysis is a function designed to help engineers to quickly complete the analysis of battery performance from the huge original data base. Through flexible data screening and curve configuration, the software will automatically calculate a series of key data such as maximum and minimum capacity, etc. Users can have higher efficiency on evaluating the capacity attenuation ratio and voltage attenuation ratio of batteries.

Fault recording, help to find out the cause of battery abnormality

Different from the traditional battery test software, the ITS5300 battery test system can not only complete safe and reliable automatic control with full protection, but also have a recording function

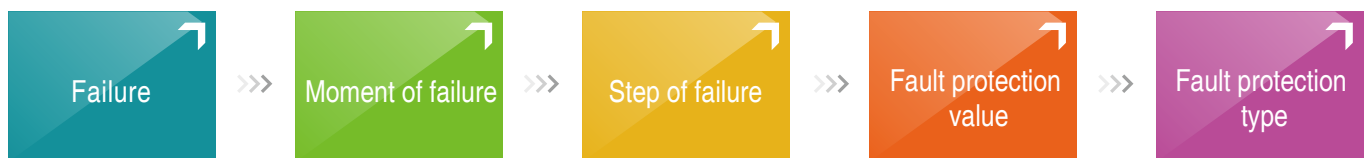

Multi-curve display, directly reflects the trend of battery performance changes

ITS5300 provides powerful curve editing functions. Users can customize the parameters of the horizontal and vertical axes to obtain different battery curves, such as C-t, CV, V-t, and so on. The operation is very flexible. More importantly, ITS5300 provides a vertical comparison and analysis function of battery performance curves, which can put the curves at different temperatures or different discharge depths in a chart, so that users can observe more directly how the battery performance is affected by external conditions.

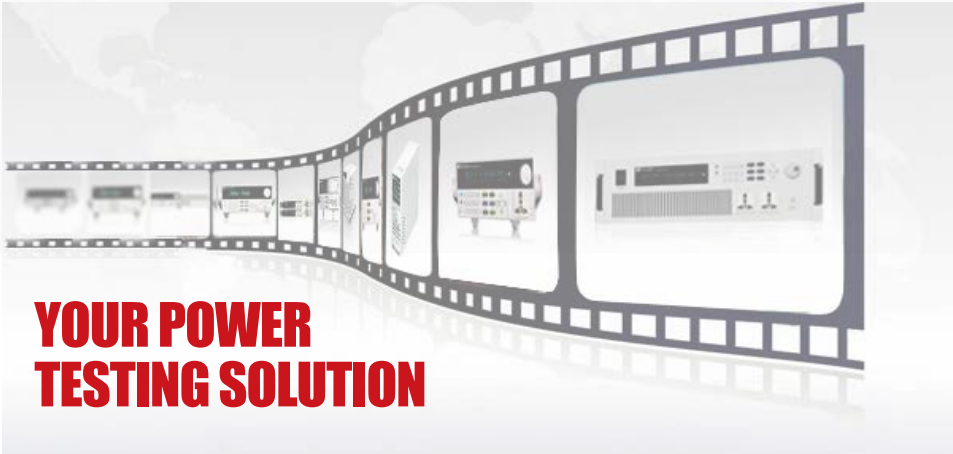
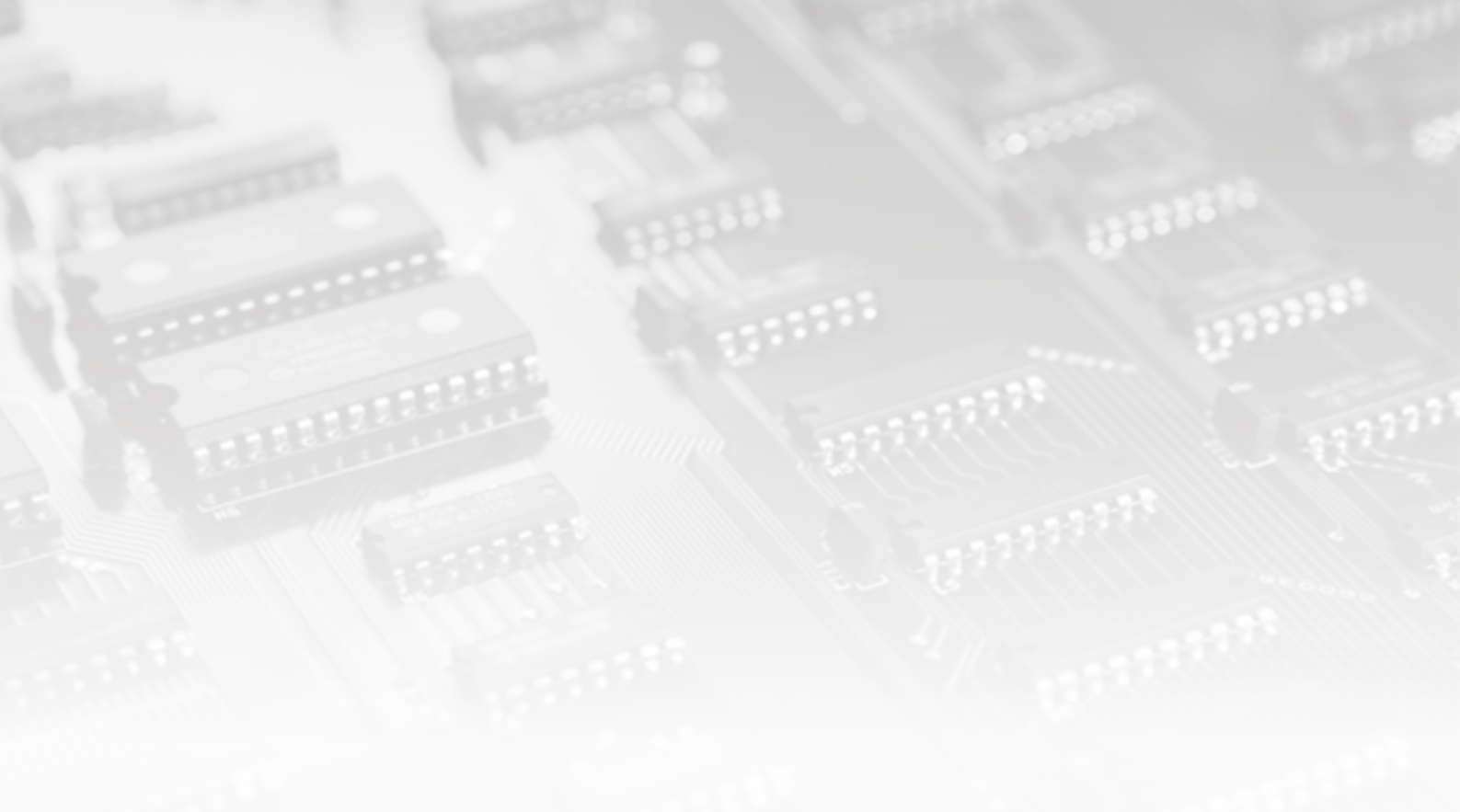

This information is subject to change without notice. For more information, please contact ITECH.

ITECH ELECTRONIC CO., LTD.

Add: No.918, Zhongzheng Rd., Zhonghe Dist., New Taipei City
235, Taiwan
Web: www.itechate.com
TEL: +886-3-6684333
E-mail: info@itechate.com



ITECH Web



ITECH Facebook



ITECH LinkedIn